

SPICER[®] AXLE

MAINTENANCE MANUAL

MODEL



FRONT AND REAR
CARRIER TYPE

600

SPICER AXLE DIVISION



DANA CORPORATION

FORT WAYNE, INDIANA

INDEX

LUBRICATION	3
IDENTIFICATION OF SERVICE TOOLS	4
AXLE IDENTIFICATION	5
FRONT AXLES — WHEEL ENDS	
Closed Knuckle Design (Hub & Drum)	6
Spring Loaded King Pin Design (Hub & Rotor)	14
REAR AXLES — WHEEL ENDS, SEMI-FLOAT DESIGN	
Unit Wheel Bearing	20
(Lubricated with Hypoid Gear Lube)	
Unit Wheel Bearing	22
(Lubricated with Grease)	
Shaft Riding Bearing	27
(Lubricated with Hypoid Gear Lube)	
REAR AXLES — WHEEL ENDS, FULL-FLOAT DESIGN	32
CARRIER SECTION	34

IMPORTANT SAFETY NOTICE

Proper service and repair is important to the safe, reliable operation of all - (Motor Vehicles) or (driving axles whether they be front or rear). The service procedures recommended and described in this service manual are effective methods for performing service operations. Some of these service operations require the use of tools specially designed for the purpose. The special tool should be used when and as recommended.

It is impossible to know, evaluate, and advise the service trade of all conceivable ways in which service might be done or the possible hazardous consequences of each way.

Accordingly, anyone who uses a service procedure or tool which is not recommended, must first satisfy himself thoroughly that neither his safety nor vehicle safety will be jeopardized by the service methods he selects.

NOTE

Throughout this manual, reference is made to certain tool numbers whenever special tools are required. These numbers are numbers of Miller Special Tools, 32615 Park Lane, Garden City, Michigan 48135.

LUBRICATION

It is not our intent to recommend any particular brand or make of lubricant for the Spicer hypoid axles. However, an S.A.E. 90 or 80W-90 multi-purpose gear lubricant meeting MIL. Spec. L-2105-C, and suitable for A.P.I. Service Classification GL-5, is suggested as a minimum requirement. It must provide necessary and suitable load-carrying characteristics to prevent scoring and wear, good stability in storage and service, and give good resistance to corrosion. Suppliers should assure these characteristics and be responsible for the quality and satisfactory performance of their product.

WHEEL BEARING LUBRICATION

Wheel bearings are lubricated by one of two different methods. One is to pack the wheel bearing with grease; while the other method is to lubricate the wheel bearing with the hypoid gear lube in the housing. For grease packing, it is recommended that a number 2 consistency, lithium base 12 hydroxy stearate grease containing an E.P. additive be used. Such a lubricant would pass a load-carrying test at 40 pounds (18.5 Kg.) minimum with base oil pour point at -10°F (-23°C) maximum.

For wheel bearings which depend on lubrication from the hypoid gear lube in the axle housing, it is recommended that an S.A.E. 80W-90 multi-purpose gear lube meeting MIL. Spec. L-2105-C be used.

NOTE

We suggest that wheel bearing lubricants selected for use with Disc Brake applications, in addition to the E.P. properties expressed in this manual, should be compatible with elevated temperatures, i.e., high temperature lubricant. For specified wheel bearing lubricant, refer to Vehicle Service Manual.

CLOSED WHEEL END STEERING KNUCKLE LUBRICATION

The closed steering knuckle requires lubrication from a source other than the gear carrier assembly. Inboard tube seals contain the hypoid gear lube in the housing to provide adequate lubricant level for the gears, bearings, etc. This then requires an additional lubricant level to be maintained outboard, in each steering knuckle, which can be observed by removing fill plugs on each knuckle. Adequate level would be to the bottom of the fill plug hole, when vehicle is observed to be in a normal horizontal position.

Recommended lubricant is an S.A.E. 140 grade, multi-purpose gear lubricant meeting the MIL-L-2105C specification.

IMPORTANT

As special equipment, limited slip differentials are provided in many vehicles, the freedom from "chatter" is a function of the lubricant used and cannot be covered in the above specification. In some applications, a special limited slip differential lubricant may be required. If required, these special lubricants are normally available through the original equipment manufacturer.

COLD WEATHER OPERATION

If the vehicle is operated below 0°F. (-18°C), it is advisable to use S.A.E. 80 or 80W-90 multi-purpose gear lubricant meeting MIL. Spec. L-2105-C and suitable for A.P.I. Service Classification GL-5.

SUBMERSION OR DEEP WATER FORDING

If the vehicle is exposed to water deep enough to cover the hubs or wheel bearing retainer plate and oil seal of either the front or rear axles, it is recommended that the wheel ends be disassembled and inspected for water damage and/or contamination daily.

In the event the gear carrier housing should become submerged in water, particularly if over the breathers, it is recommended that the hypoid gear lubricant be drained daily and internal parts be inspected for water damage and/or contamination.

Clean, examine and replace damaged parts, if necessary, prior to assembling the cover housing and refilling with the specified hypoid lubricant.

NOTE

It is recommended that whenever bearings are removed they are to be replaced with new ones, regardless of mileage.

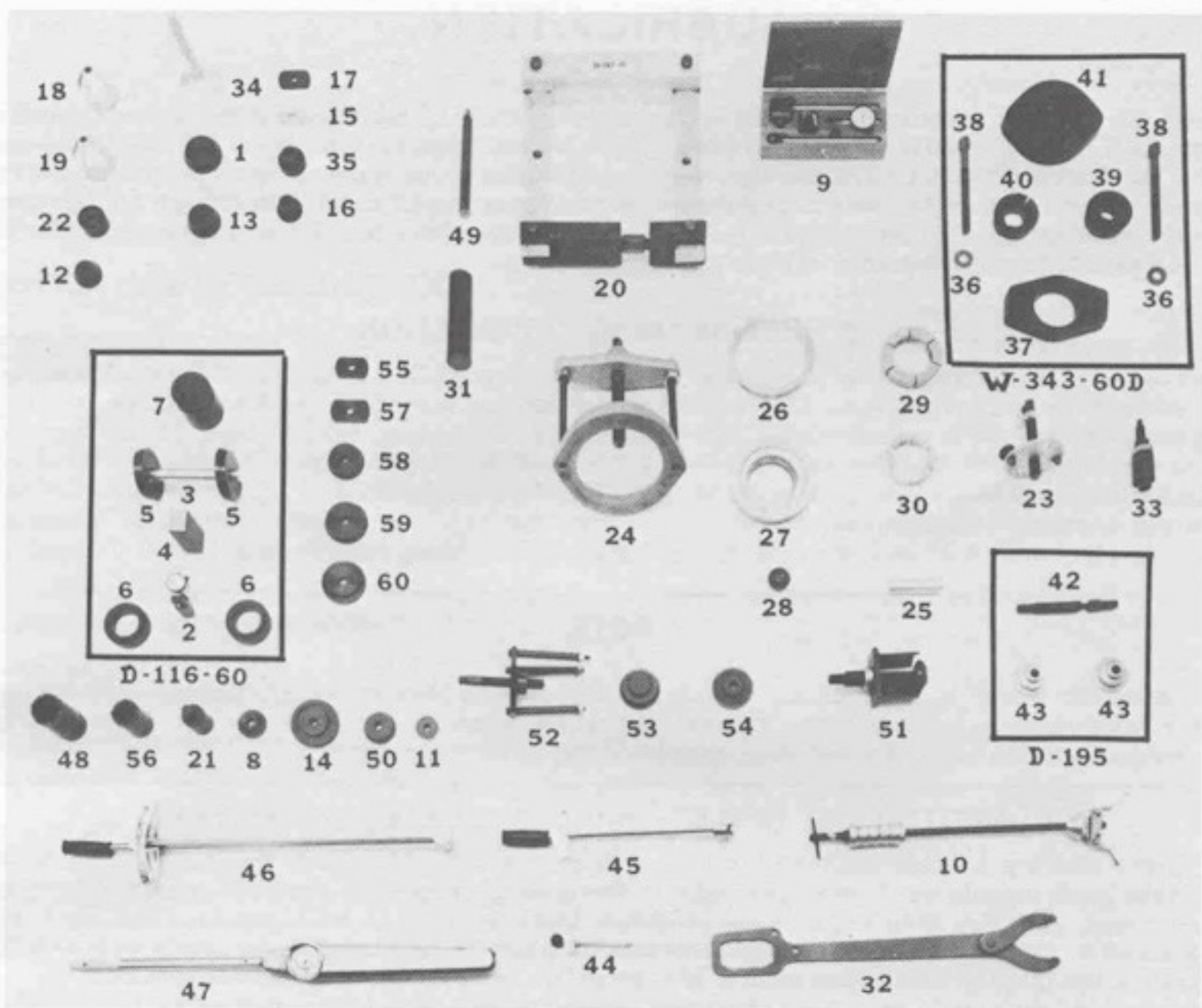

Figure 2

1019-2

The following is a detailed list of all special service tools required to service a Model 60 Front or Rear axle:

ITEM NO.	TOOL NO.	DESCRIPTION
1	D-111	Installer - Rear Pinion Bearing Cup
* 2	D-115	Scooter Gauge
* 3	D-115-3	Arbor
* 4	D-116-1	Pinion Height Block
* 5	D-116-2	Arbor Discs
* 6	D-117	Master Bearing Differential
* 7	D-120	Master Pinion Block
8	D-258	Installer - Front Spindle Needing Bearing
9	D-128	Dial Indicator Set
10	D-131	Puller - Slide Hammer
11	D-141	Installer - Front Spindle Bushing
12	D-142	Installer - King Pin Bearing Cup (Heavy Duty)
13	D-153	Installer - Front Brake Hub Inner Bearing Cup (Reg.)
14	D-155	Installer - Front Brake Hub Grease Seal (Reg. & Heavy Duty)
15	D-158	Remover - Front Pinion Bearing Cup
16	D-161	Installer - Closed Ball Spindle Bushing
17	D-162	Remover - Rear Pinion Bearing Cup
18	D-163	Installer - Pinion Oil Seal (National)
19	D-164	Installer - Pinion Oil Seal (Chicago Rawhide)
20	D-167	Spreader - Differential Carrier
21	D-192	Remover & Installer - Tapered King Pin Upper Ball Joint Pivot Stud
22	D-194	Installer - Steering Knuckle Lower Bearing Seal
23	C-452	Remover - Universal Joint Companion Flange or Yoke
24	DD-914-P	Puller Press
25	DD-914-7	Extension
26	DD-914-8	Reducer Ring
27	DD-914-9	Reducer Ring
28	DD-914-42	Button
29	DD-914-62	Adapter Set - Differential Bearing Cones
30	C-293-37	Adapter Set - Rear Pinion Bearing Cone
31	C-3095-A	Installer - Rear Pinion Bearing Cone

ITEM NO.	TOOL NO.	DESCRIPTION
32	C-3281	Wrench - Universal Joint Flange or Yoke
33	C-3718	Installer - Universal Joint Flange or Yoke
34	C-4025-A	Installer - Differential Side Bearings
35	C-4026-A	Installer - Axle Shaft Outer Oil Seal
**36	SP-320	Washers
**37	SP-5017	Adapter Ring
**38	SP-5026	Bolts
**39	SP-5440	Adapter Ring - Installer
**40	SP-5441	Adapter Set - Removing
**41	SP-5443-A	Flange Plate
***42	D-195-2	Screw
***43	D-195-1	Installer - Front Axle Differential Inner Oil Seal
44	D-193	Torque Wrench - 50 Inch Pound
45	C-524-A	Torque Wrench - 100 Foot Pound
46	C-4053	Torque Wrench - 300 Foot Pound
47	DD-994	Torque Wrench - 1000 Foot Pound
48	C-4170-A	Wrench - Wheel Bearing Lock Nut Adjusting

49	C-4171	Handle - Universal
50	C-4203	Installer - Front Pinion Bearing Cup
51	D-232-1	Remover - Bearing
52	D-247	Installer - Press
53	D-248	Installer - Bearing
54	D-233	Installer - Oil Seal
55	D-255	Cup Remover (Hub & Drum)
56	D-165A	Wheel Bearing Wrench
57	D-257	Cup Remover
58	D-254	Installer - Cup (Outer-Hub & Rotor)
59	D-256	Installer - Cup (Inner-Hub & Rotor)
60	D-253	Seal Installer

* Pinion Setting Gauge and Master Differential Bearing Kit D-116-60.

** Axle Shaft Bearing Removing and Installing Kit W-343-60D.

*** Inner Axle Shaft Seal Installing Kit D-195.

NOTE: Torque Wrenches D-193, C-524-A, C-4053, and DD-994 are optional and can be purchased separately. These torque wrenches are not included in the DW-60 Axle Tool Kit.

AXLE IDENTIFICATION

All Spicer axles are identified with a manufacturing date and the complete part number stamped in the right hand tube. Also each axle contains a gear ratio tag, and if the axle is equipped with a limited slip differential, it will contain a tag specifying the use of limited slip lubricant.

the axle. The next number is the part (bill of material) number. The six digits reading from left to right is the basic number for identifying the particular axle assembly. The seventh digit following the dash will identify ratio, differential and end yoke options used in the assembly.

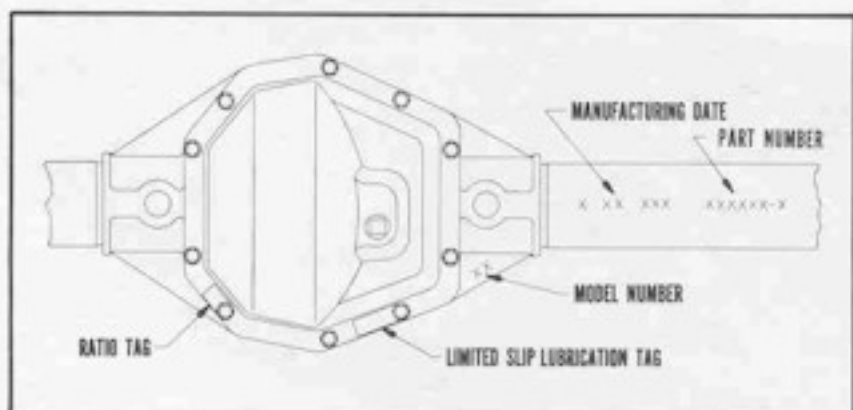

Figure 3

1019-3

In this figure the axle is identified with 1/8" (3.17 mm) high numbers stamped in the tube. For Example: The manufacturing date or build date of the axle is interpreted as follows. The first number is the month, second number is the day of the month, the third number is the year, the letter is the shift, and the last number is the line that built

NOTE

In the event there are two build dates, the latter will be the date in which the brake components were assembled. The number stamped next to the manufacturing date is the complete axle assembly part number.

It is recommended that when referring to the axle, obtain the complete part number and build date. To do this, it may be necessary to wipe or scrape off the dirt etc., from the tube.

NOTE

On front driving axles, the above numbers can be either on the long or short tube.

AXLE IDENTIFICATION

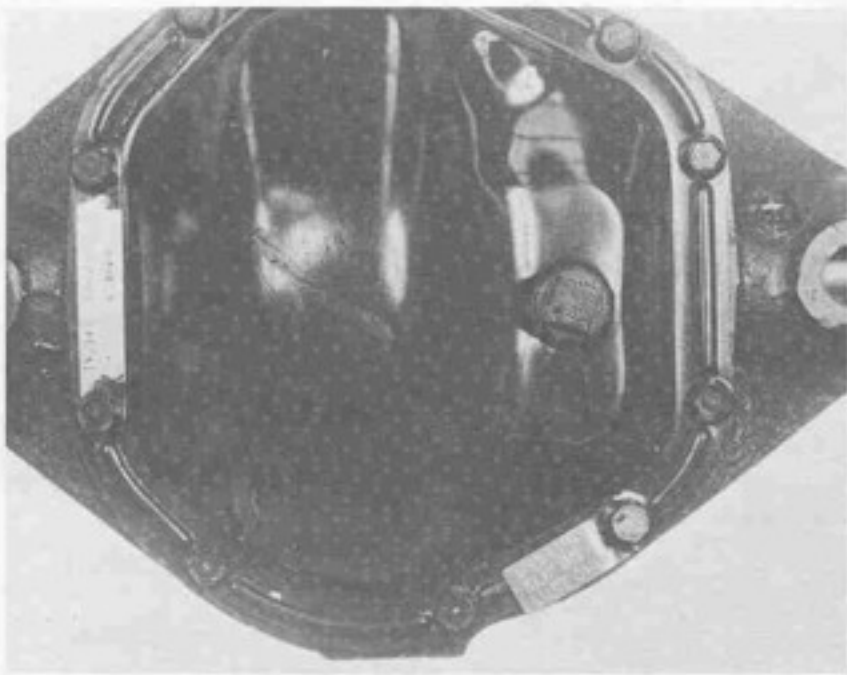

Figure 4

1019-4

The gear ratio tag is located on the left side of the cover plate/or at the bottom left hand side of the cover plate, and is held in place with one or two cover plate screws. This tag gives the tooth combination of the ring and pinion, and also the total gear ratio.

FRONT AXLE

DISASSEMBLY AND REASSEMBLY OF HUBS, DRUMS, WHEEL BEARINGS, ETC. (CLOSED KNUCKLE DESIGN)

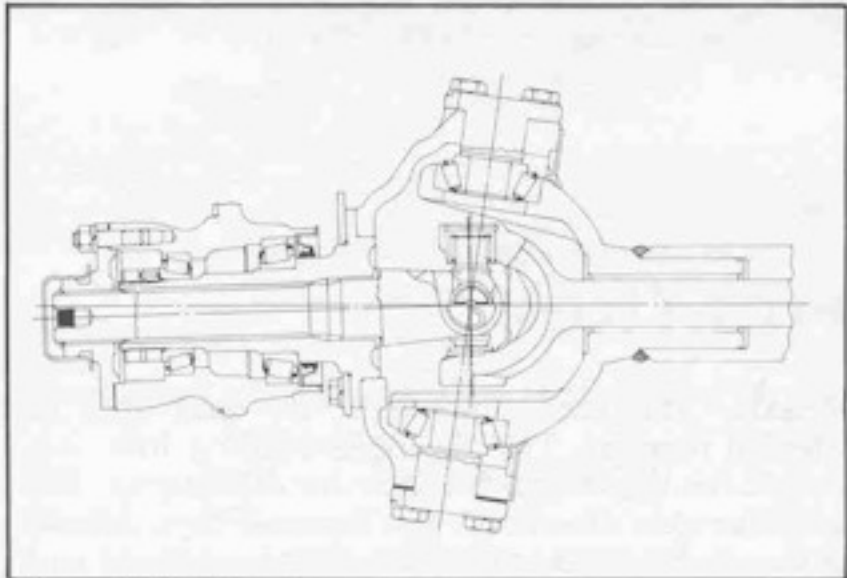

Figure L/D 5

1019-5

Remove wheel from drum assembly.

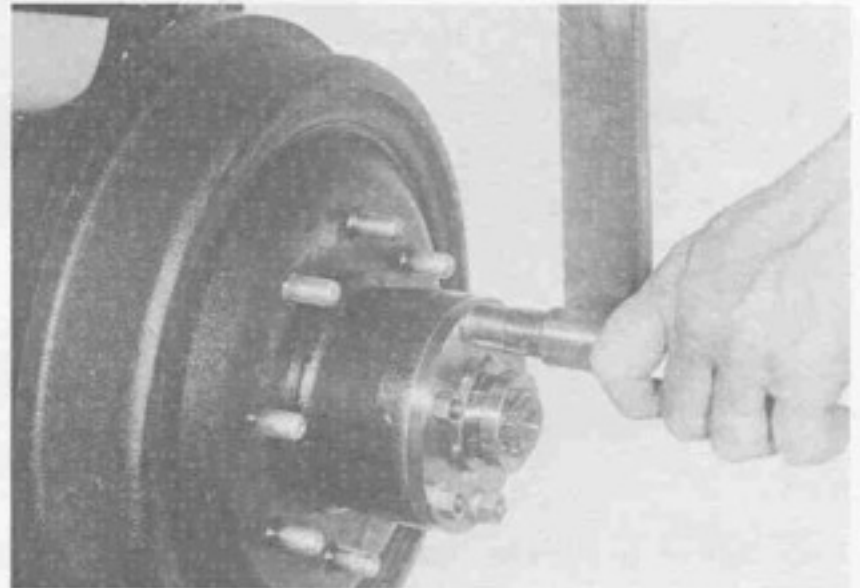

Figure 7

1019-7

Remove nuts and washers from drive flange studs.

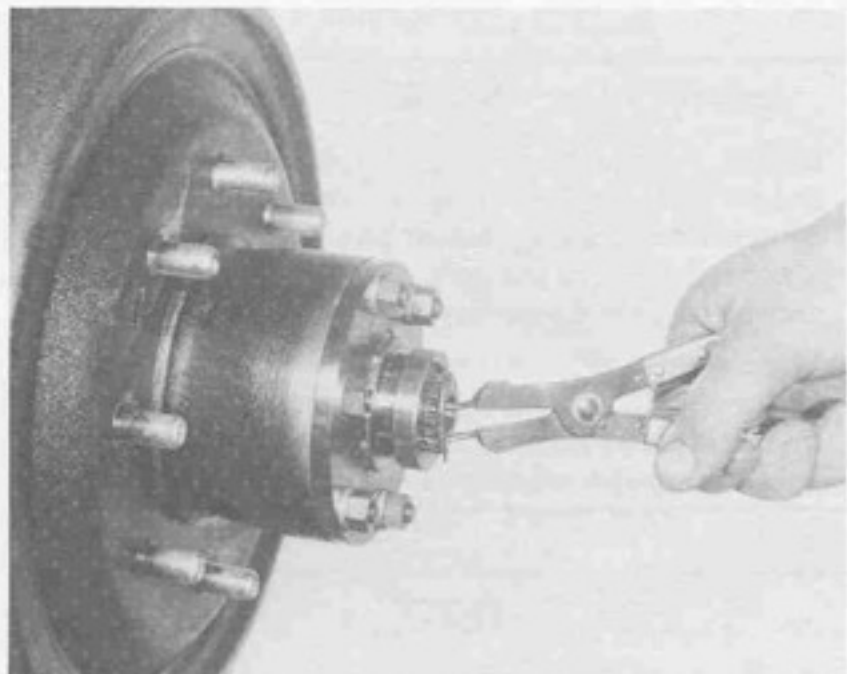

Figure 6

1019-6

Remove hub cap and snap ring.

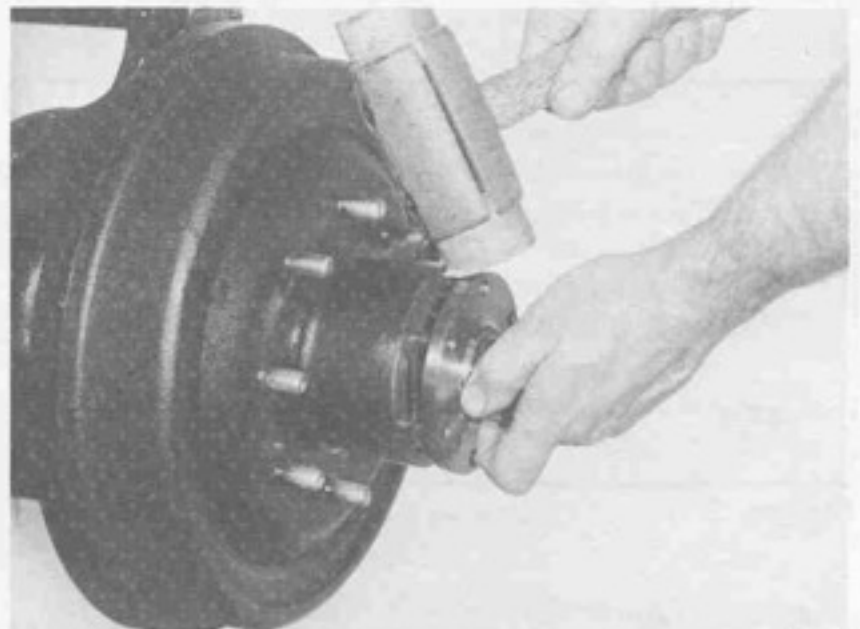

Figure 8

1019-8

Remove drive flange and gasket. Discard gasket. Replace with new one at time of assembly. To free flange from hub, tap lightly with a rawhide hammer.

FRONT AXLE

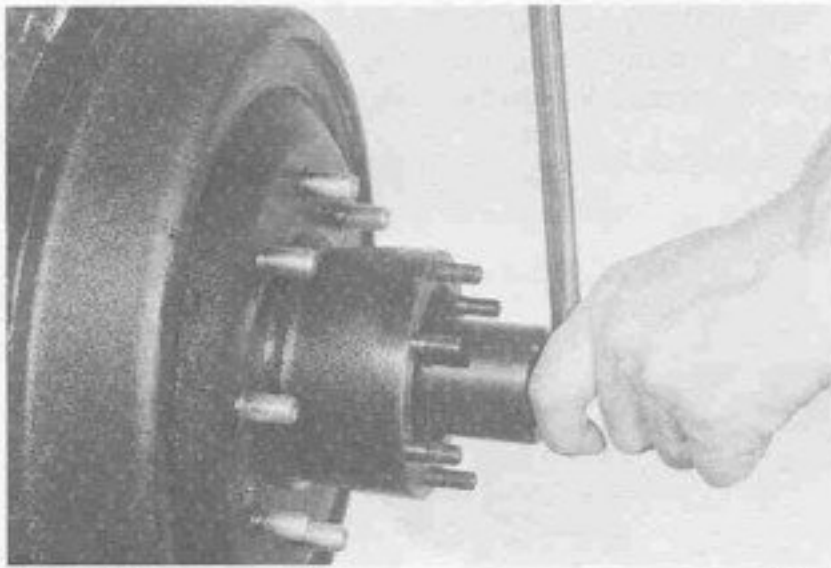

Figure 9 1019-9
Remove outer locknut, lockring, and inner wheel bearing adjusting nut.

Tool: #C-4170 Wheel Wrench.

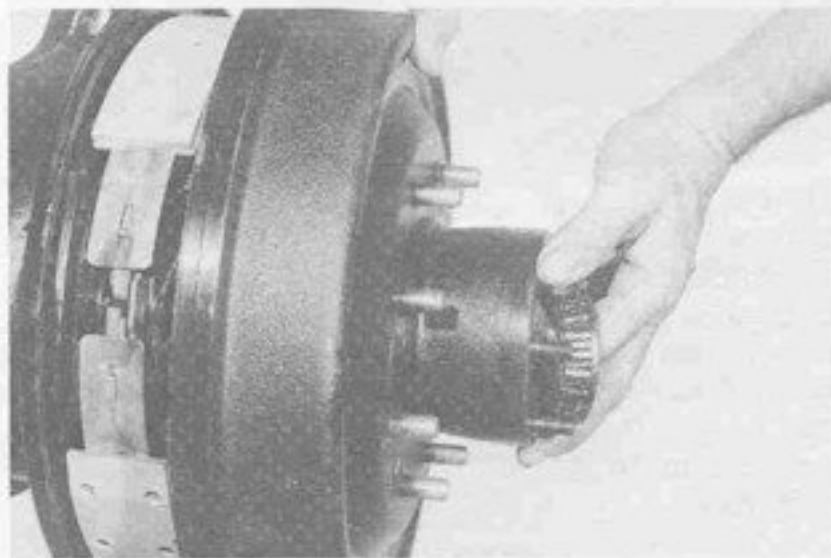

Figure 10 1019-10
Remove drum assembly. Outer wheel bearing will slide out as drum is removed.

NOTE

If it is necessary to replace brake components such as drums, shoes, backing plate, etc., refer to vehicle service manual.

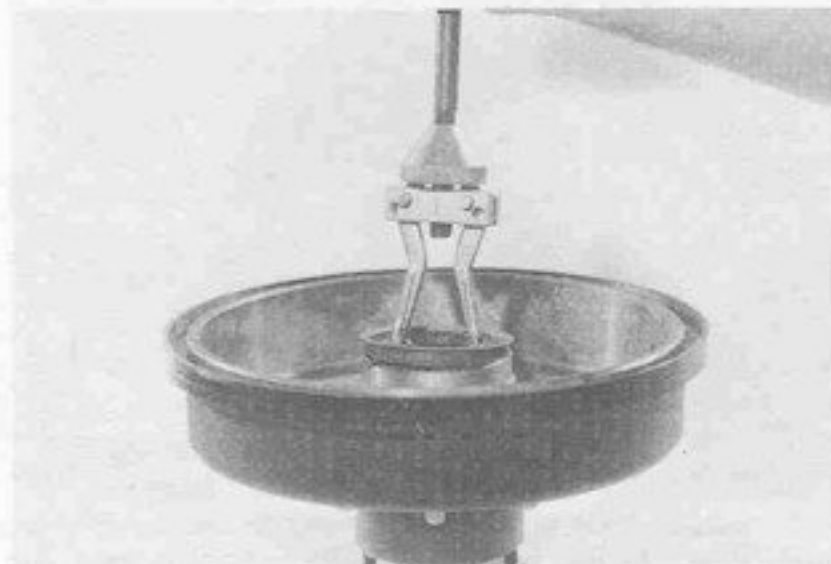

Figure 11 1019-11

Remove grease seal and inner bearing cone. Discard seal and replace with new one at time of assembly.

Tool: #D-131 Slide Hammer.



Figure 12 1019-12
Remove inner and outer wheel bearing cups.
Tools: #D-255 Cup Remover, #C-4171 Handle.

ASSEMBLY



Figure 13 1019-13
Assemble outer wheel bearing cup.
Tools: #C-4023 Installer, #C-4171 Handle.

FRONT AXLE



Figure 14

1019-14

Assemble inner wheel bearing cup.

Tools: #D-111 Installer, #C-4171 Handle.

Distribute a sufficient amount of grease inside the hub between the bearing cups.

Pack inner bearing cone full with the specified grease. Wipe the excess grease around the rollers. Assemble inner wheel bearing cone into cup.



Figure 15

1019-15

Assemble new grease seal. Apply a small amount of grease around lip of seal.

Tools: #D-155 Seal Installer, #C-4171 Handle.

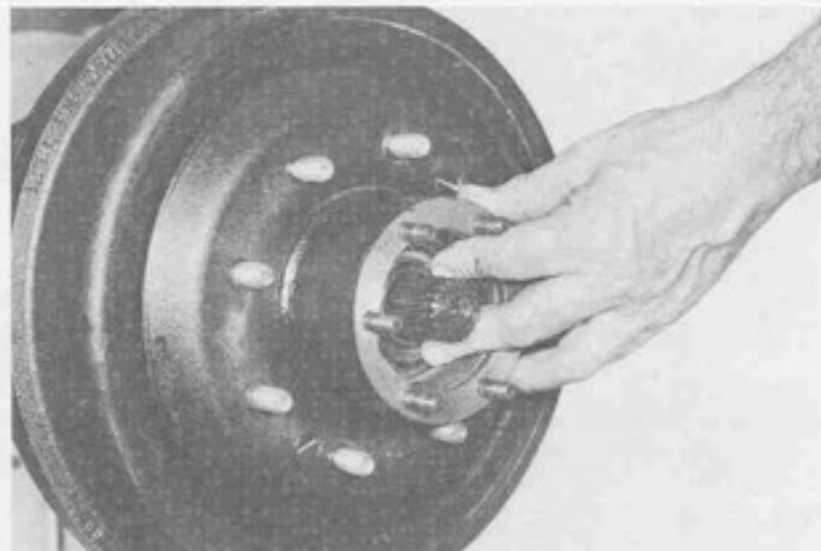

Figure 16

1019-16

Assemble hub and drum onto spindle. Pack outer wheel bearing with specified grease, wipe excess grease around the rollers. Assemble onto spindle.

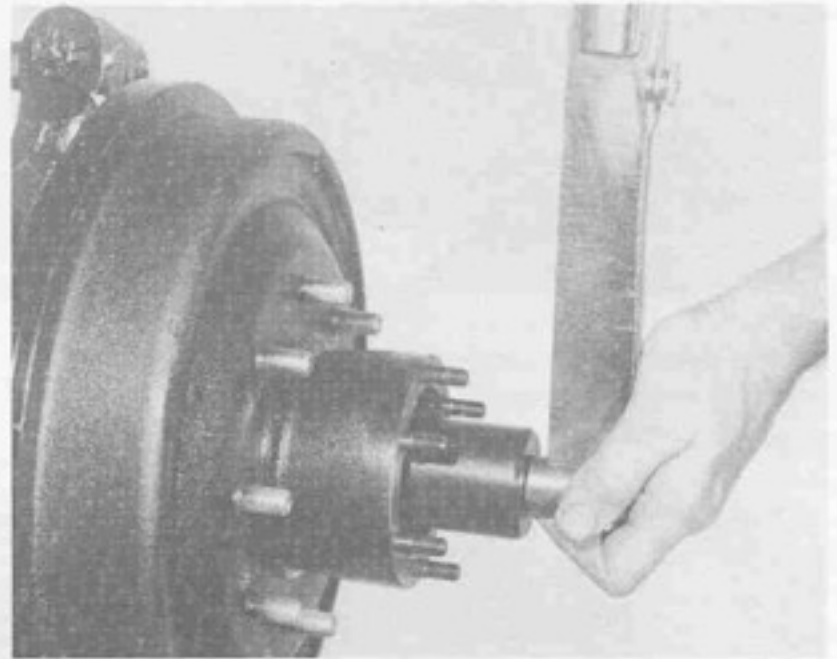

Figure 17

1019-17

To adjust wheel bearings, torque inner adjusting nut to 50 Lb. Ft. (68 N·m) to seat bearings. Rotate hub, then back off inner adjusting nut one fourth turn maximum. Assemble lock washer, turn nut to the nearest hole in washer. Assemble outer locknut and torque to 50 Lb. Ft. (68 N·m). Final bearings adjustment to be .001''-.010'' (.03-.25 mm) total end play.

Tools: #C-4170 Wheel Bearing Wrench, #C-524A Torque Wrench.

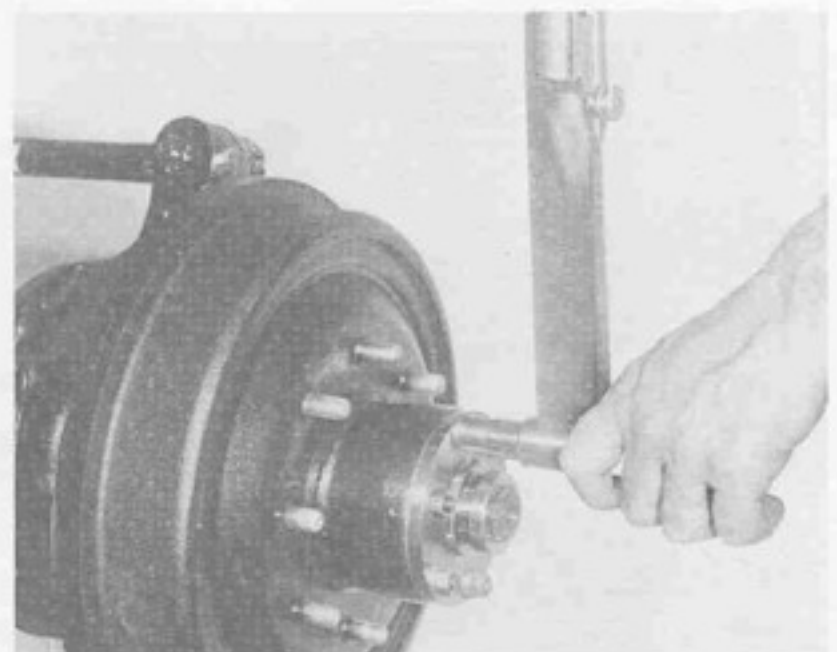

Figure 18

1019-18

Assemble new gasket, drive flange, lockwashers, and nuts. Refer to Vehicle Service Manual for proper torque specifications.

FRONT AXLE

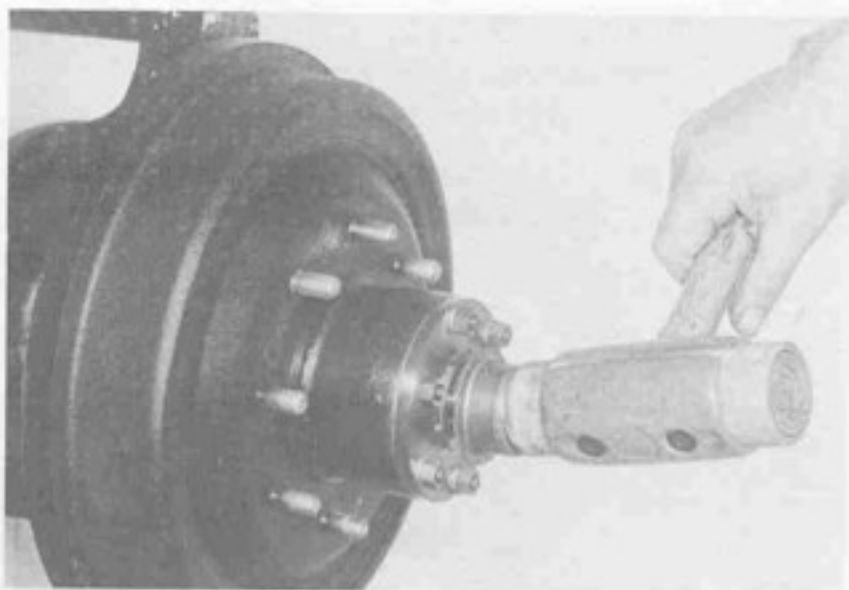

Figure 19 1019-19
Assemble snap ring and hub cap. Tap lightly with hammer to seat hub cap.

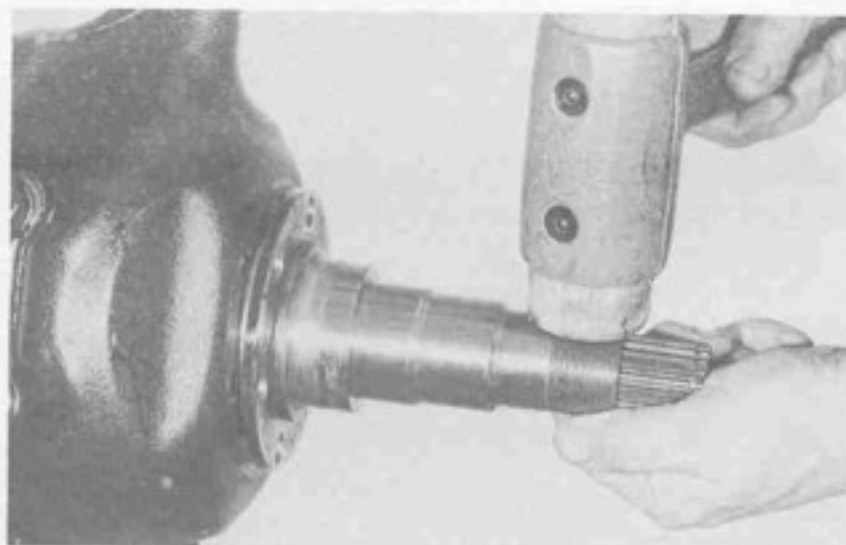

Figure 21 1019-21
Remove spindle. Tap lightly with a rawhide hammer to break the spindle loose from the knuckle.

DISASSEMBLY AND REASSEMBLY OF SHAFTS, SPINDLE KNUCKLES, AND ETC., (CLOSED KNUCKLE DESIGN)

Remove wheel, hub and drum assembly as shown in Figure 6 thru 10.

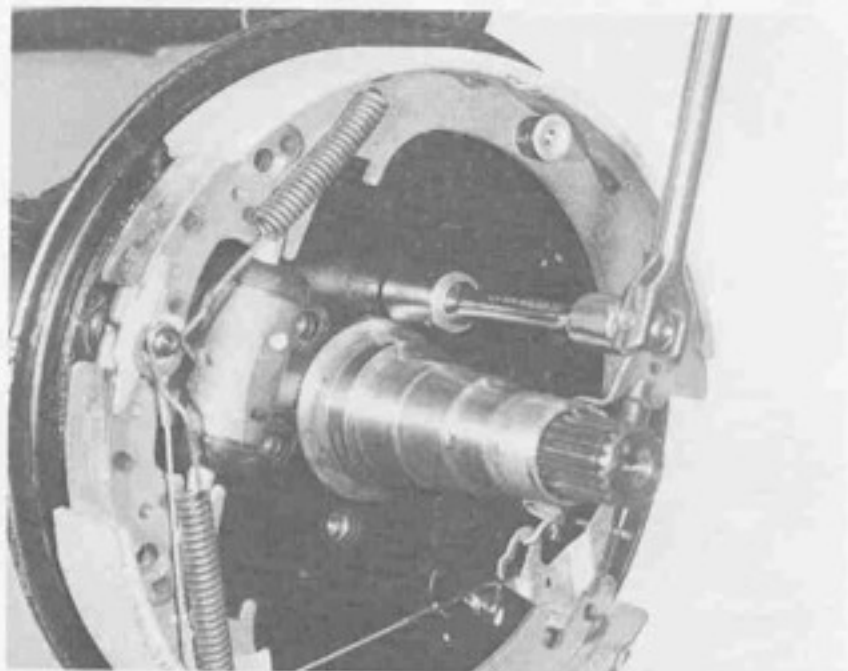

Figure 20 1019-20
Remove backing plate screws and remove backing plate.

NOTE

The brake backing plate assembly can be retained with screws or nuts. If the nuts are of the torque prevailing design, they are to be replaced with new ones.

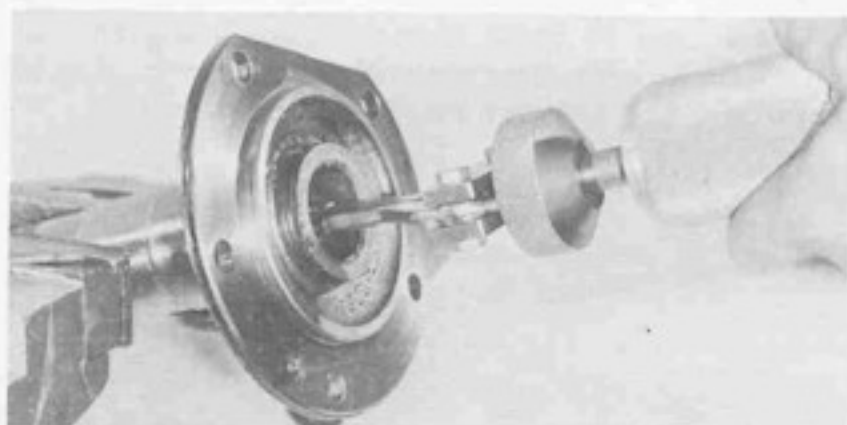

Figure 22 1019-22
Place spindle in vise, do not locate on bearing diameters.

CAUTION

Be sure that the vise jaws are equipped with brass protectors or similar type to protect the machined surfaces of any parts that are to be placed in the vise.

Remove bronze bushing with slide hammer puller.

Tool: #D-131 Slide Hammer.

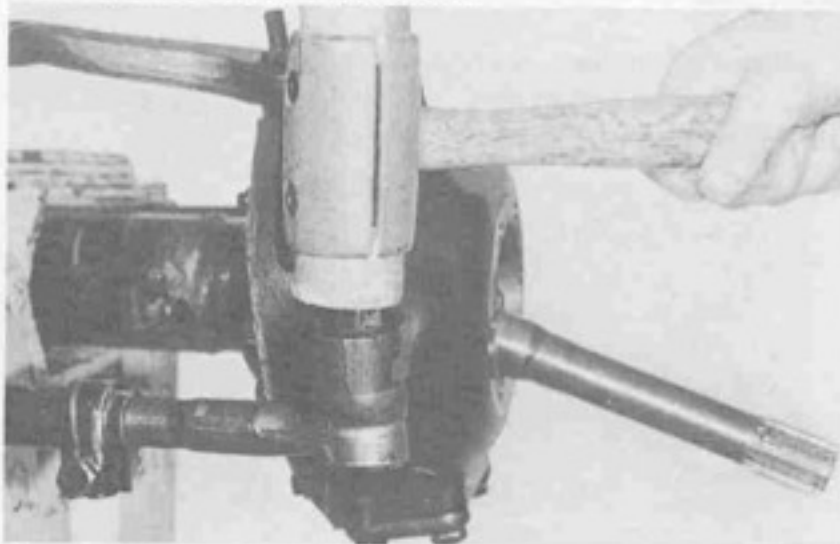

Figure 23 1019-23
Remove cotter key and loosen tie rod nut. Tap on nut with rawhide hammer to break the stud loose from the steering arm. Remove nut and disconnect tie rod.

FRONT AXLE

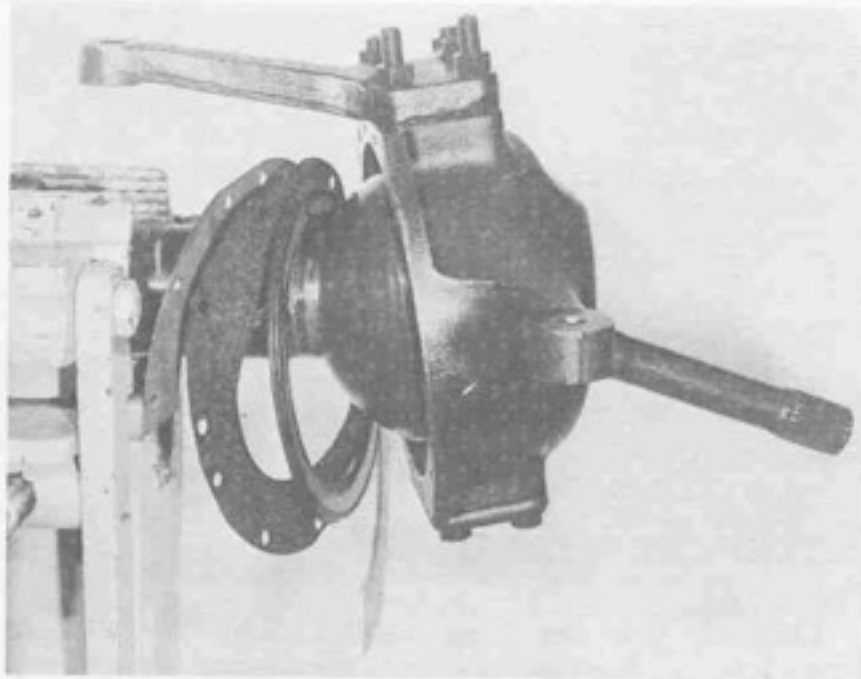

Figure 24 1019-24

Remove twelve cap screws, two retainer plates, felt seal, and oil seal. Discard retainer plates, felt seal, and oil seal. Replace with new ones at time of assembly. Cut felt seal in half to disassemble.

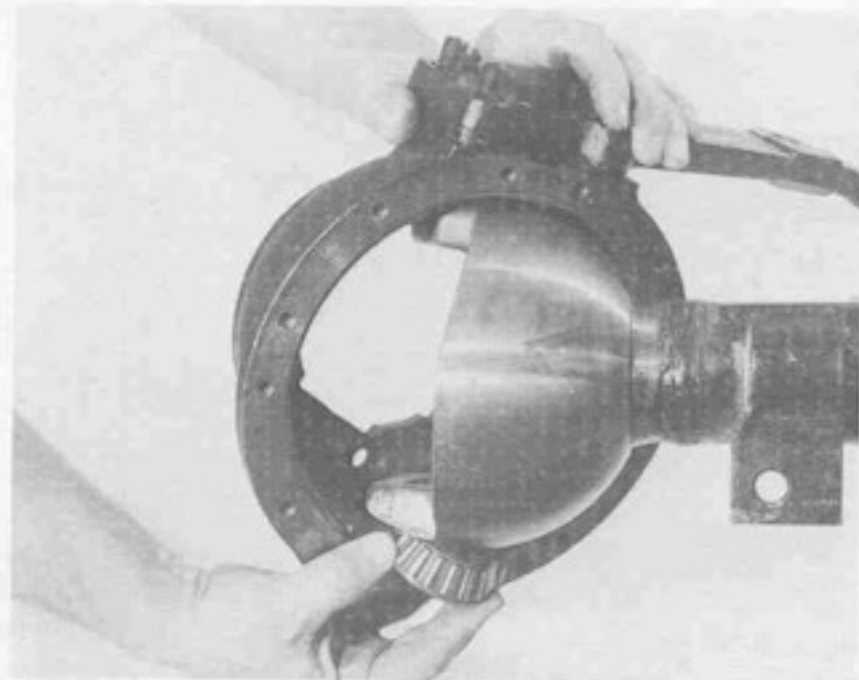

Figure 26 1019-26

Remove knuckle from ball yoke.

CAUTION

The bottom bearing cone will fall out as the knuckle is being removed. To prevent damage to the bearing, catch it with hand.

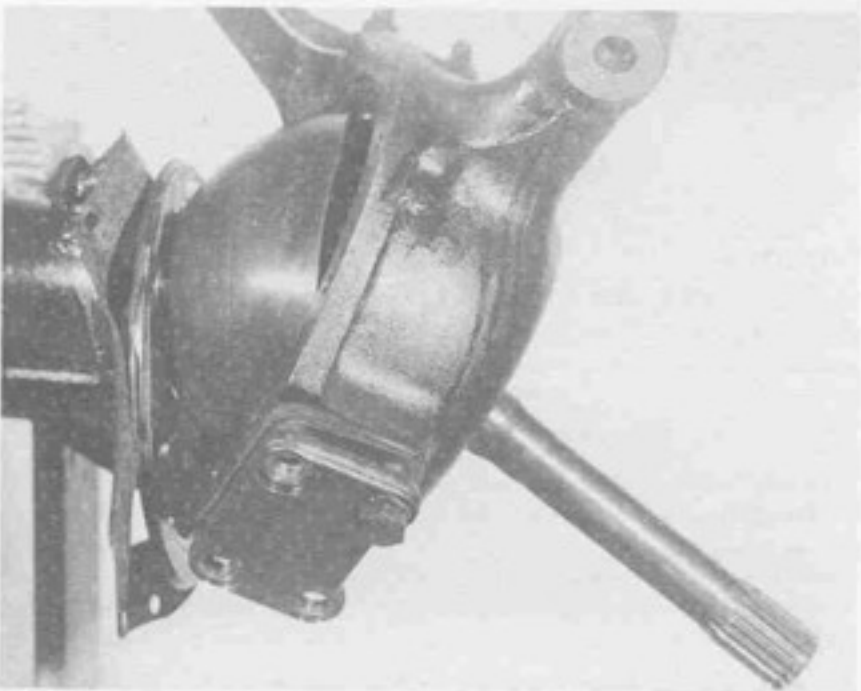

Figure 25 1019-25

Remove four cap screws from the bottom bearing cap. Use a screwdriver to loosen the bearing cap from the knuckle if necessary.

NOTE

King pin bearing preload shims are located between the bottom bearing cap and knuckle. Wire shims together as they will be used during assembly. Shims may stick to either the knuckle or bearing cap. Be sure you have them all collected.

Shims are available in thicknesses of .003", .005", .010", and .030" (mm .08, .13, .25, and .76). Remove axle shaft joint assembly.

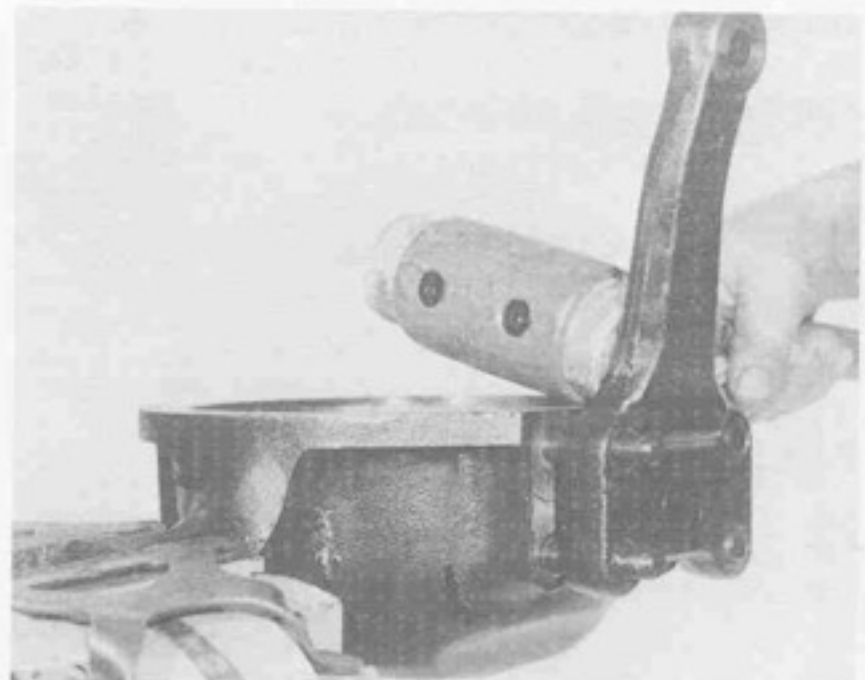

Figure 27 1019-27

Place knuckle in vise as shown. Remove steering arm. Tap lightly with a rawhide hammer to free it from the knuckle.

NOTE

Some axles are equipped with a constant shim pack between the steering arm bearing cap and knuckle. If used, this pack is to be saved and reused during assembly.

FRONT AXLE

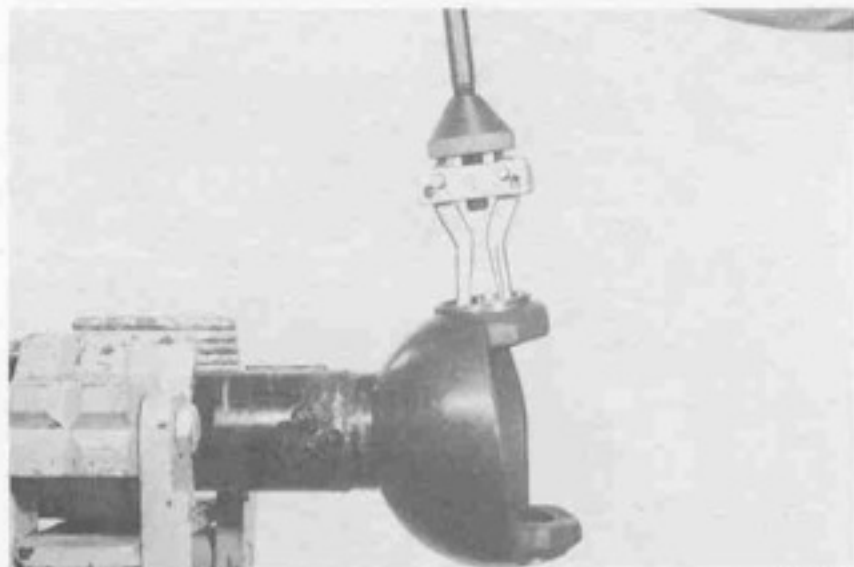

Figure 28 1019-28
Remove king pin bearing cups from spherical ball yoke, with tool as shown.
Tool: #D-131 Slide Hammer.



Figure 31 1019-31
Assemble new bronze bushing into ball yoke.
Tools: #D-161 Installer, #C-4171 Handle.

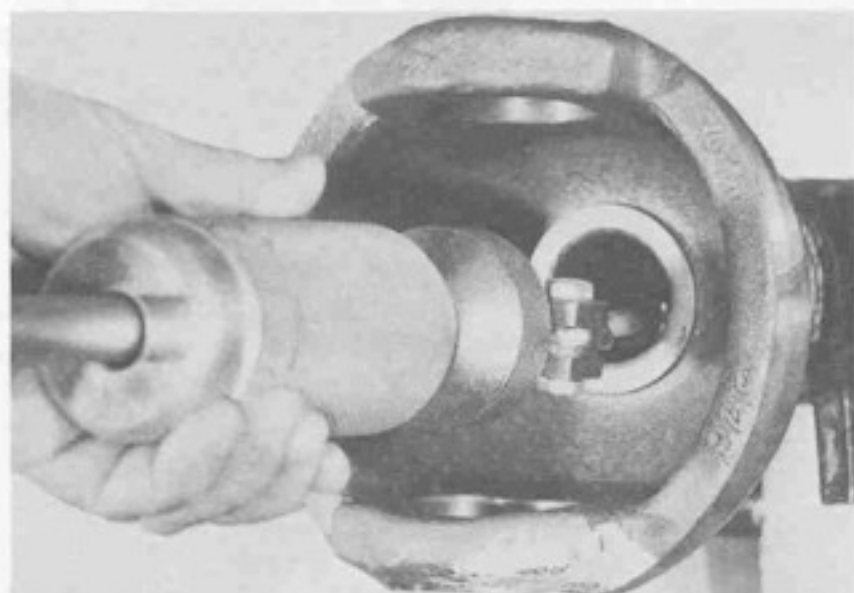

Figure 29 1019-29
Remove bronze bushing from ball yoke.
Tool: #D-131 Slide Hammer.

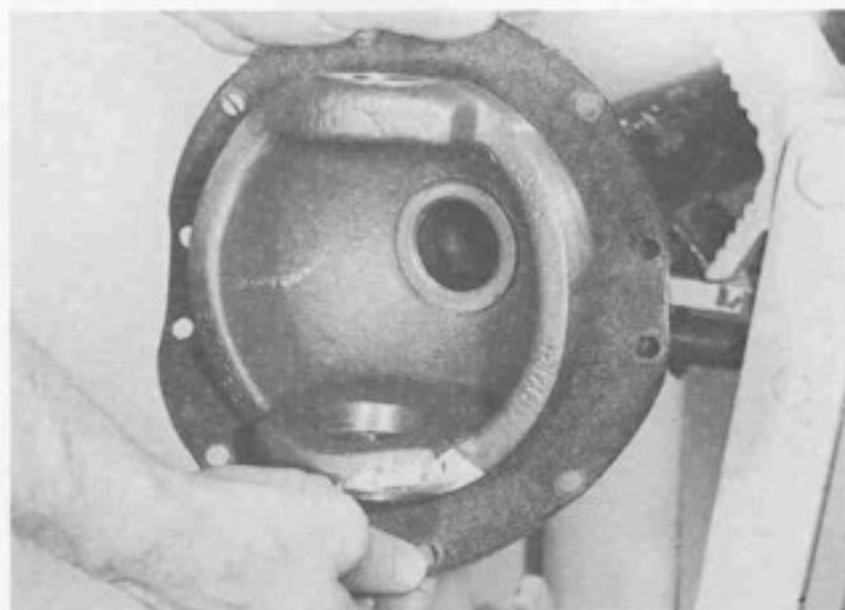

Figure 32 1019-32
Assemble new felt over spherical ball as shown.

ASSEMBLY

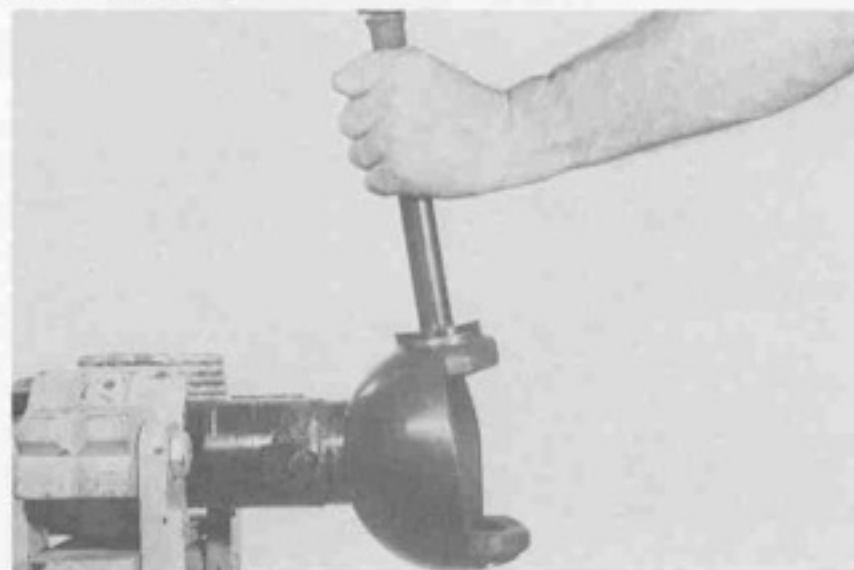

Figure 30 1019-30
Assemble new king pin bearing cups into spherical ball yoke. Use tools as shown.
Tools: #D-142 Installer, #C-4171 Handle.



Figure 33 1019-33
Assemble new oil seal with the metal part of the seal towards the end of the axle. Spread split of seal just enough to slip over the tube of the axle.

FRONT AXLE

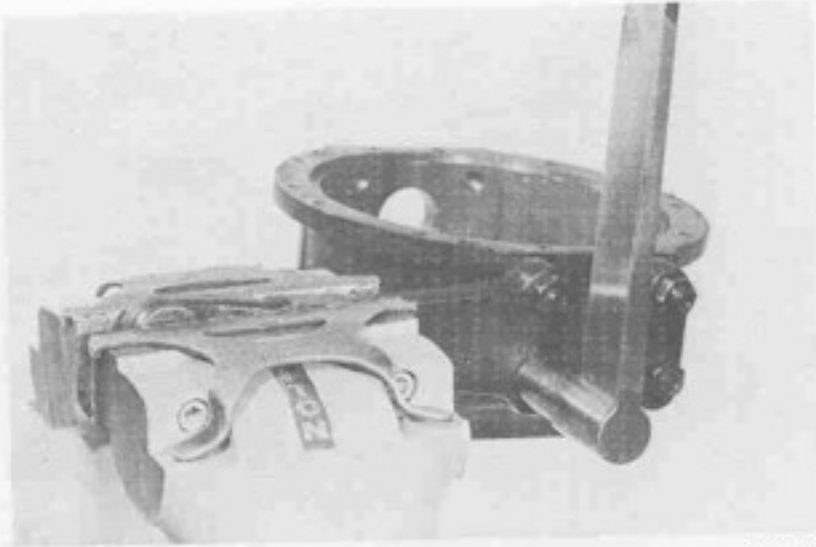

Figure 34

1019-34

Locate steering arm in vise as shown. Assemble constant shim pack to the knuckle (if used). Assemble knuckle to the steering arm. Assemble the four nuts, tighten nuts alternately and evenly. Torque nuts to 70-90 Lb. Ft. (95-122 N·m).

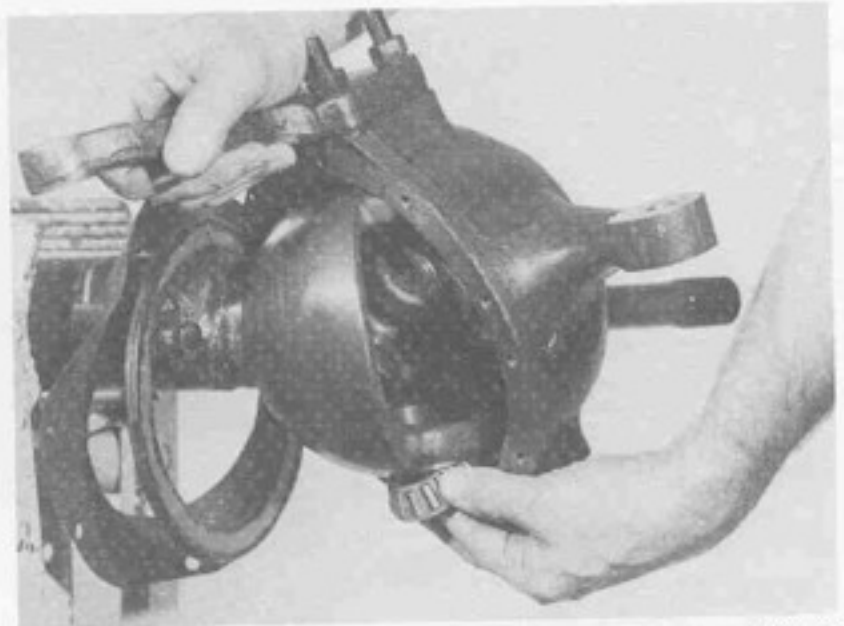

Figure 37

1019-37

Assemble knuckle to ball yoke. Hold bottom bearing (new) as shown to prevent it from falling out.

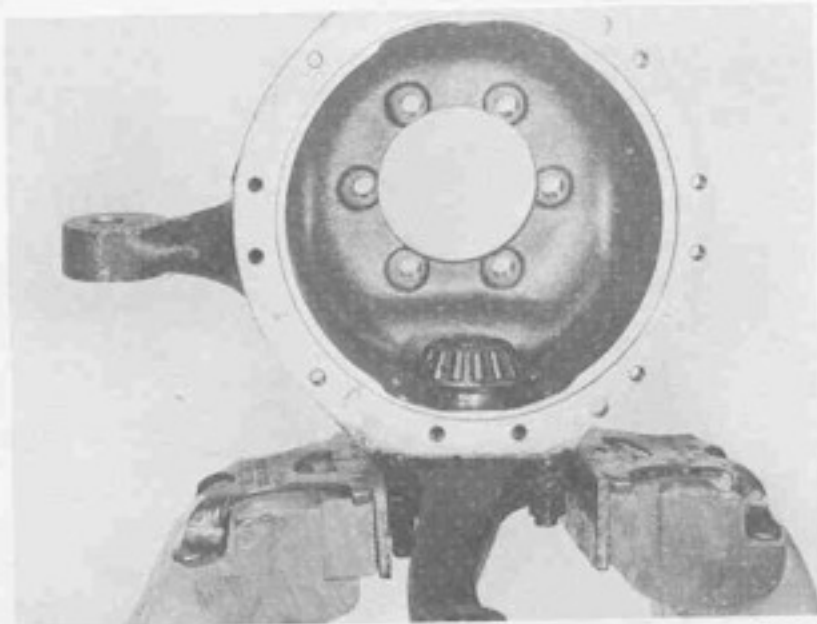

Figure 35

1019-35

Assemble new bearing cone to king pin, grease bearing with specified grease.

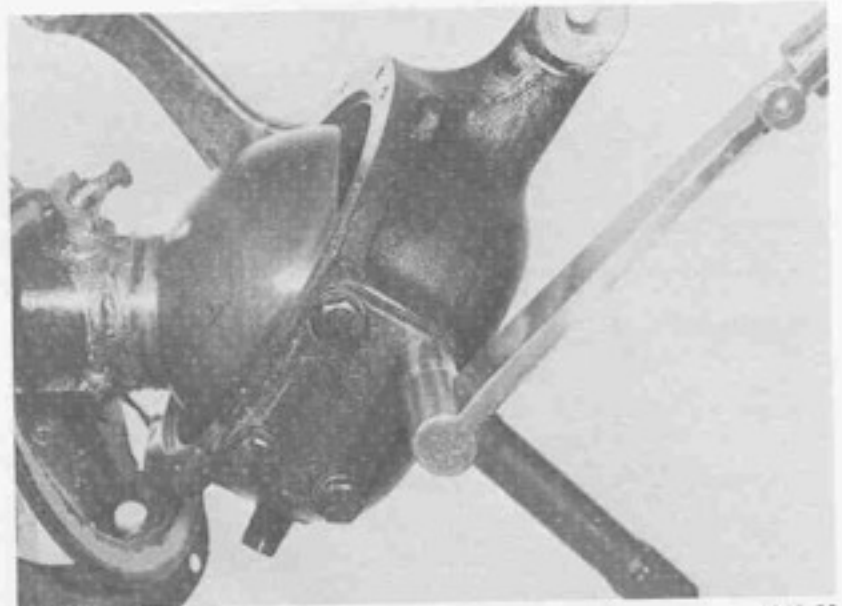

Figure 38

1019-38

Assemble bottom king pin bearing cap, with preload shims, and four cap screws. Torque screws to 70-90 Lb. Ft. (95-122 N·m).

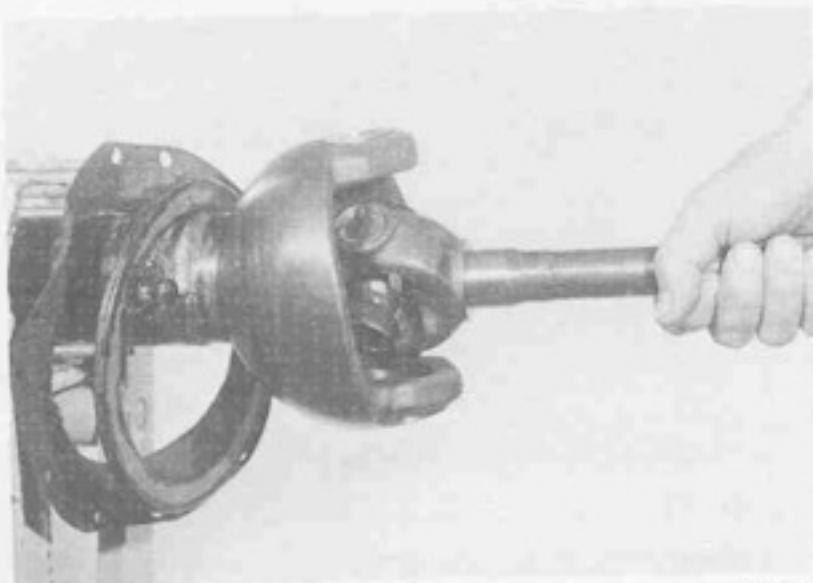

Figure 36

1019-36

Assemble axle shaft joint assembly into housing.

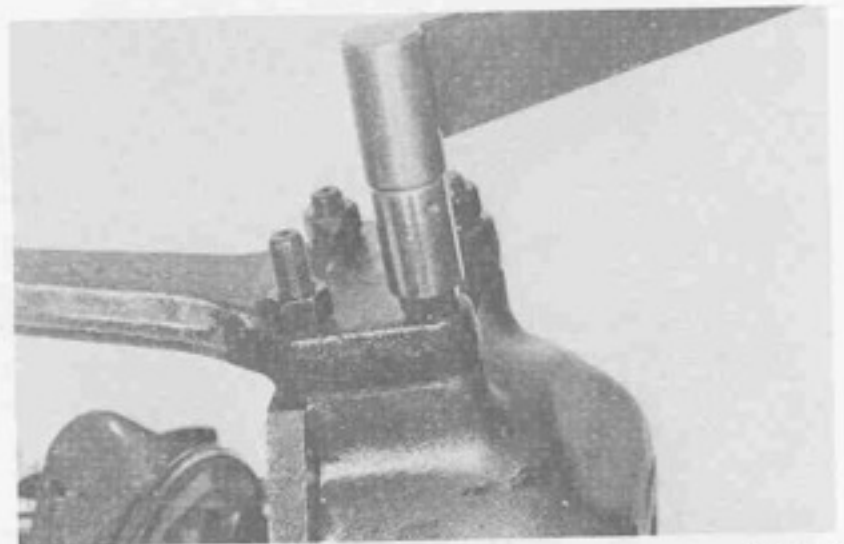

Figure 39

1019-39

Place a torque wrench on steering arm nut as shown. Torque to actuate knuckle to 9-15 Lb. Ft. (12-20 N·m). When checking torque rotation of knuckle, make sure tie rod and seals are not assembled to knuckle.

FRONT AXLE

NOTE

If preload is too tight, correct by adding shims. If preload is too loose, correct by removing shims. Preload shim pack is located on the bottom between the bearing cap and knuckle. Shims are available in thicknesses of .003", .005", .010", and .030" (mm .08, .13, .25, and .76).

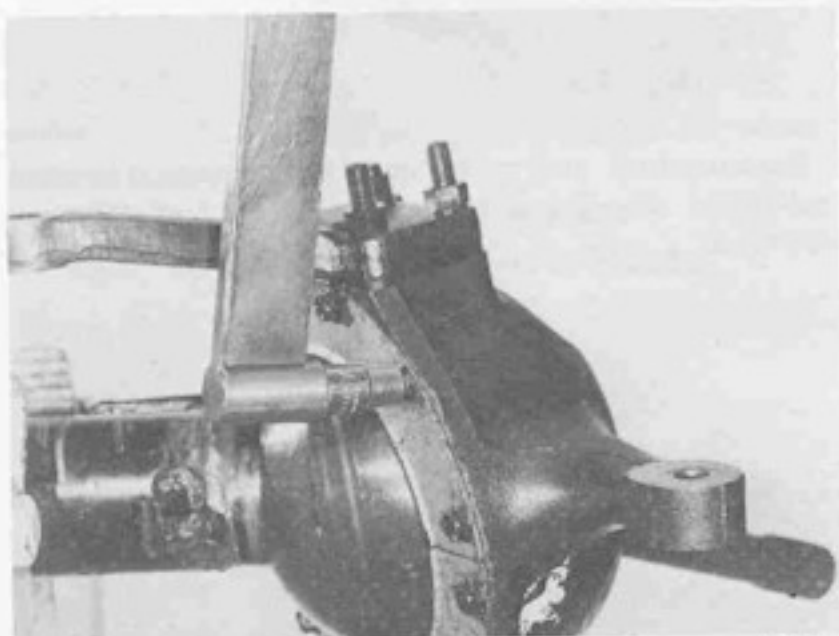

Figure 40

1019-40

Assemble new oil seal into knuckle. Be sure split of seal is to the top of the axle. Assemble new felt, two retainer plates and twelve cap screws. Torque screws to 15 Lb. Ft. (20 N·m).

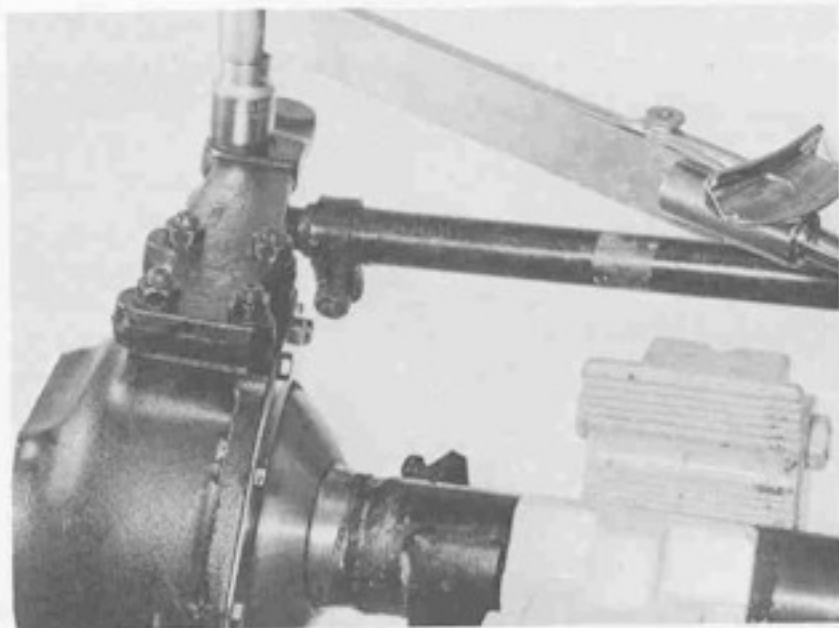

Figure 41

1019-41

Assemble tie rod to steering arm for specified torque on tie rod nut, refer to Vehicle Service Manual. Assemble cotter key.

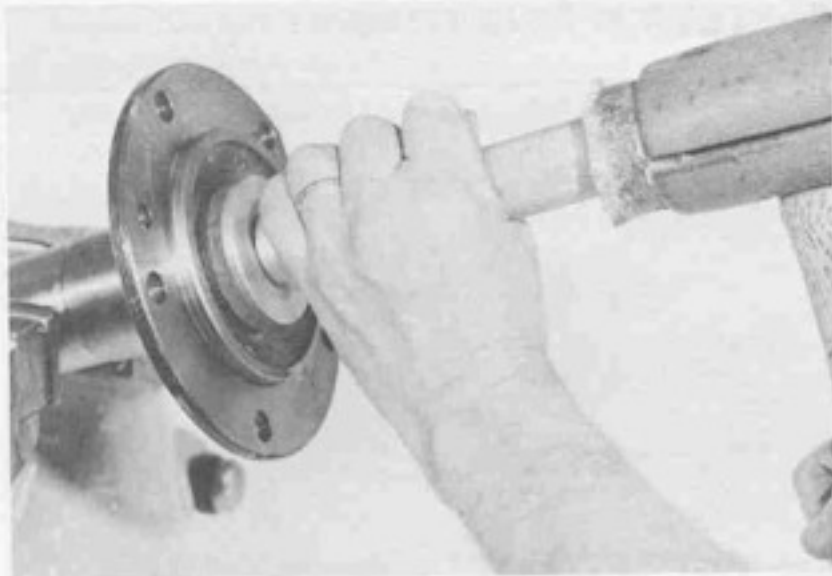

Figure 42

1019-42

Position spindle in vise as shown and assemble new bushing. Grease inside of bushing with specified grease.

Tools: #D-141 Installer, #C-4171 Handle.

Assemble spindle to knuckle.

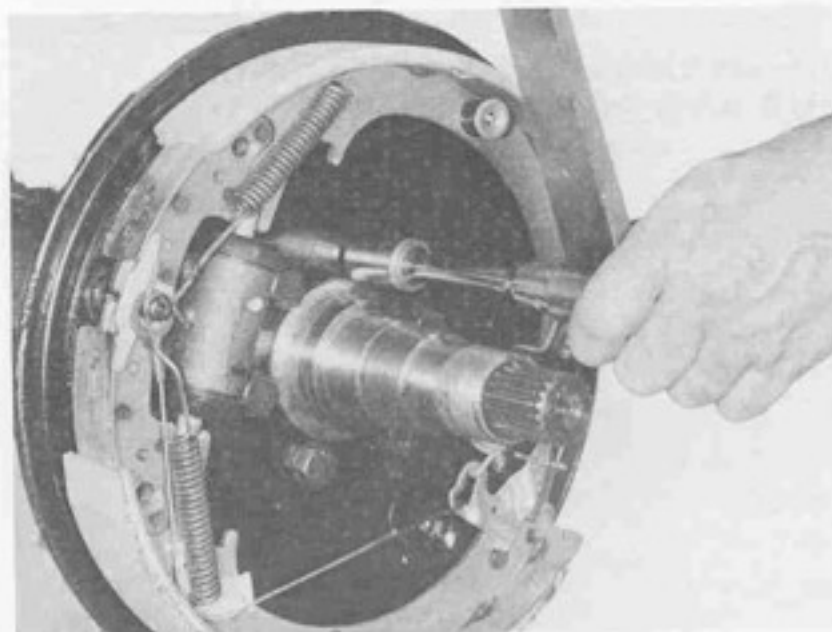

Figure 43

1019-43

Assemble brake backing plate assembly. Refer to Vehicle Service Manual for specified screw torque.

Remove inspection plug from knuckle and fill level to the plug hole with specified lubricant. Assemble inspection plug.

NOTE

To set toe-in refer to Vehicle Service Manual. Adjustments can be made by loosening clamps on the tie rod. After proper adjustments are made, retighten tie rod clamps.

FRONT AXLE

40° STEER SPRING LOADED

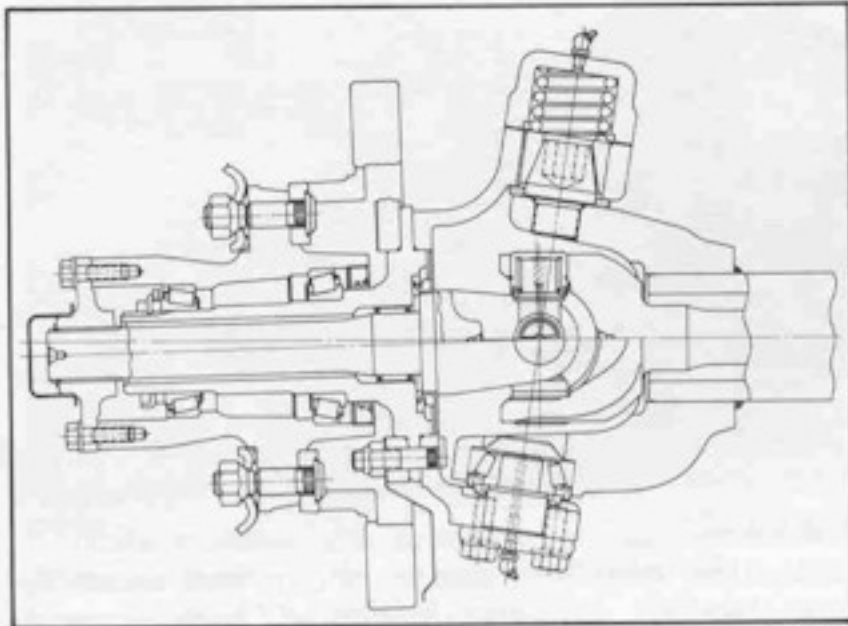

Figure 44 L/D

1019-44

DISASSEMBLY OF WHEEL ENDS - HUB AND ROTOR

NOTE

If it is necessary to replace brake components such as disc brake pads, backing plate, etc., refer to Vehicle Service Manual.

Remove Wheel from Hub and Rotor Assembly. Follow the vehicle manufacturers recommendations for the removal of the hub-lok assembly, if used.

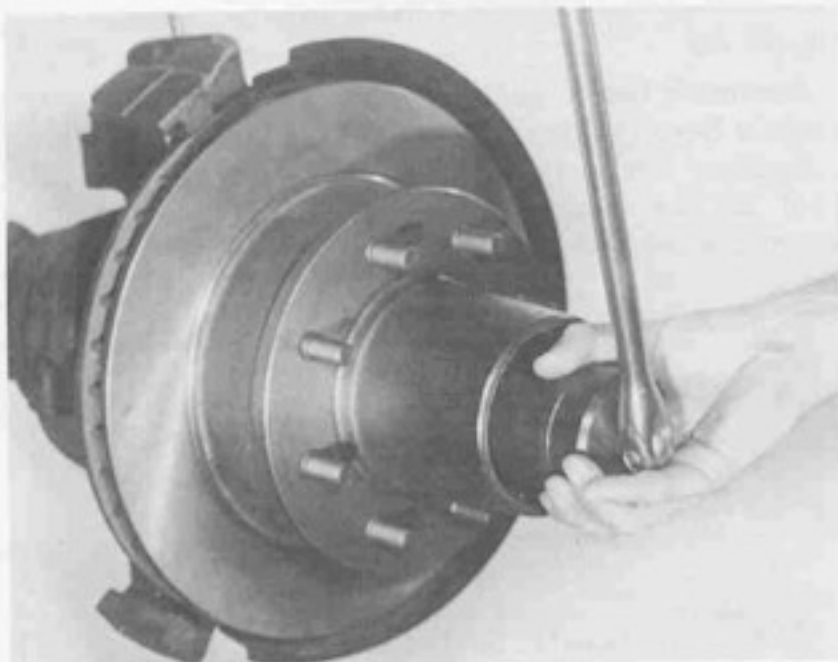

Figure 45

1019-45

Remove wheel bearing lock nut, lock ring and the wheel bearing adjusting nut.

Tool: #D-165A Wheel Bearing Wrench.



Figure 46

1019-46

Remove hub and rotor assembly, spring retainer and outer wheel bearing will slide out as rotor is removed.



Figure 47

1019-47

Remove grease seal and inner bearing cone. Discard seal and replace with new one at time of assembly.

Tool: #D-131 Slide Hammer.



Figure 48

1019-48

Remove inner and outer wheel bearing cups.

Tools: #D-255 Bearing Cup Remover (outer). #D-257 Bearing Cup Remover (inner).

FRONT AXLE



Figure 49 1019-49
Assemble outer wheel bearing cup.
Tools: #D-254 Installer, #C-4171 Handle.



Figure 50 1019-50
Assemble inner wheel bearing cup.
Tools: #D-256 Installer, #C-4171 Handle.

Distribute a sufficient amount of grease inside the hub between the bearing cups. Pack inner bearing cone full with the specified grease. Wipe the excess grease around the rollers. Assemble inner wheel bearing cone into cup.



Figure 51 1019-51

Assemble new grease seal. Apply a small amount of grease around lip of seal.

Tools: #D-253 Seal Installer, #C-4171 Handle.

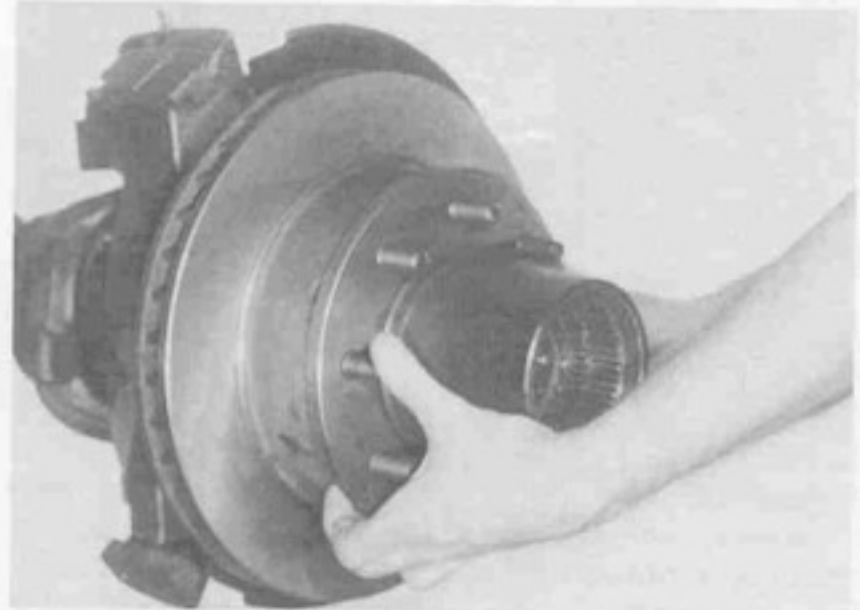

Figure 52 1019-52
Assemble hub and rotor onto spindle. Pack outer wheel bearing with specified grease, wipe excess grease around the rollers. Assemble onto spindle.



Figure 53 1019-53
To adjust wheel bearings, torque inner adjusting nut to 50 Lb. Ft. (68 N·m) to seat bearings. Rotate hub, then back off inner adjusting nut one-fourth turn maximum. Assemble lock washer, turn nut to nearest hole in washer. Assemble outer locknut and torque to 50 Lb. Ft. (68 N·m). Final bearings adjustment to be .001-.010 (.03-.25 mm) total end play.

Tools: #D-165A Wheel Bearing Wrench, #C-512A Torque Wrench.

NOTE

For servicing spindle and knuckle, remove hub and drum as described in figures 45 through 47.

FRONT AXLE

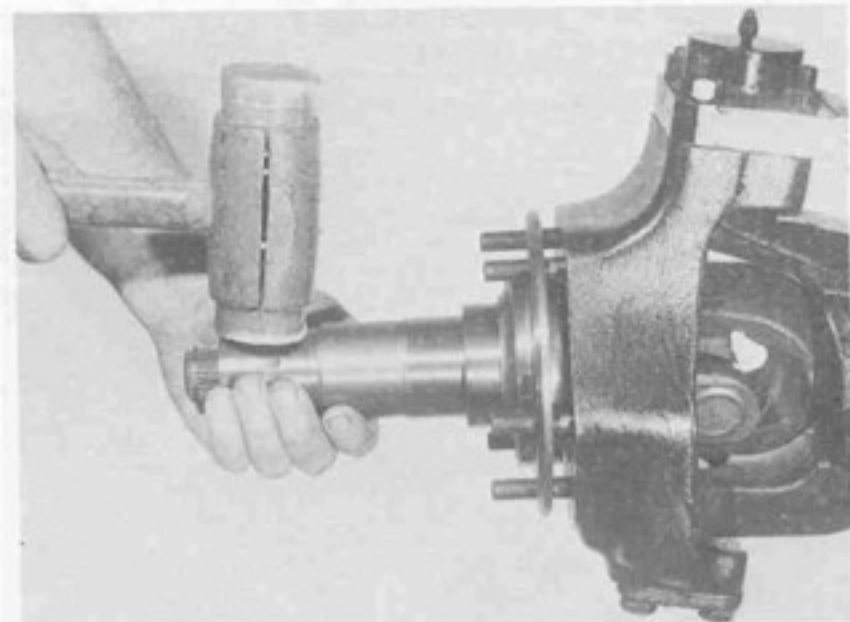

1019-54

Figure 54

Remove spindle. If necessary, tap lightly with a rawhide hammer to free it from the knuckle. Check bronze spacer located between axle shaft joint assembly and bearing. If wear is evident, replace with a new one.

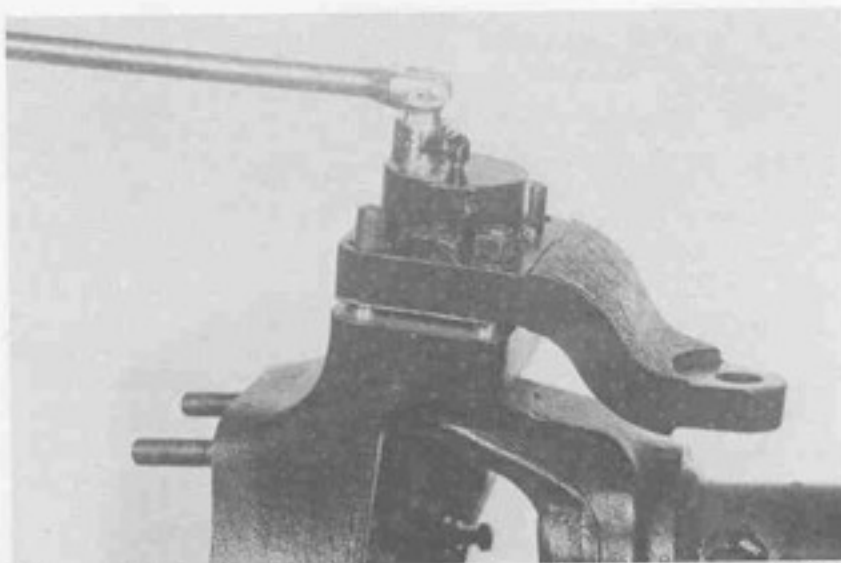

1019-56

Figure 56

Remove four nuts on steering arm. Remove nuts alternately as compression spring will force steering arm up.

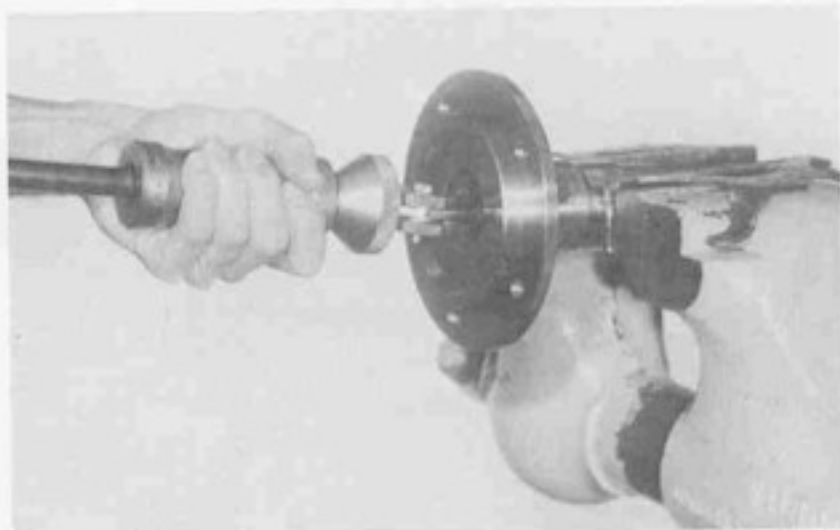

1019-55

Figure 55

Place spindle in vise. Do not locate on bearing diameters. Remove needle bearing.

Tool: #D-131 Slide Hammer.



1019-57

Figure 57

Remove steering arm, compression spring, and gasket. Discard gasket, replace with new one at time of assembly.

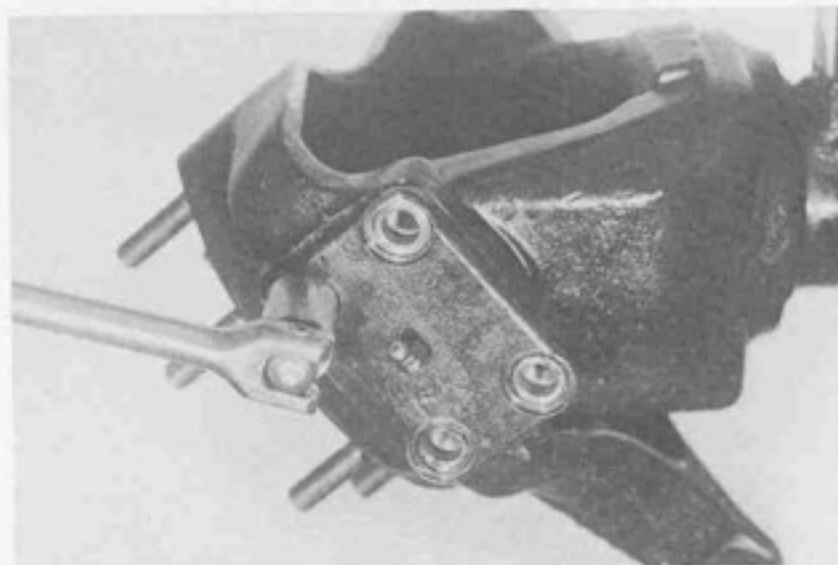

1019-58

Figure 58

Remove four cap screws on bearing cap. Remove bearing cap.

CAUTION

Be sure that vise jaws are equipped with brass protectors or similar type to protect the machined surfaces of any parts that are to be placed in the vise.

Remove axle shaft joint assembly. Remove tie rod. Refer to Figure 23.

FRONT AXLE

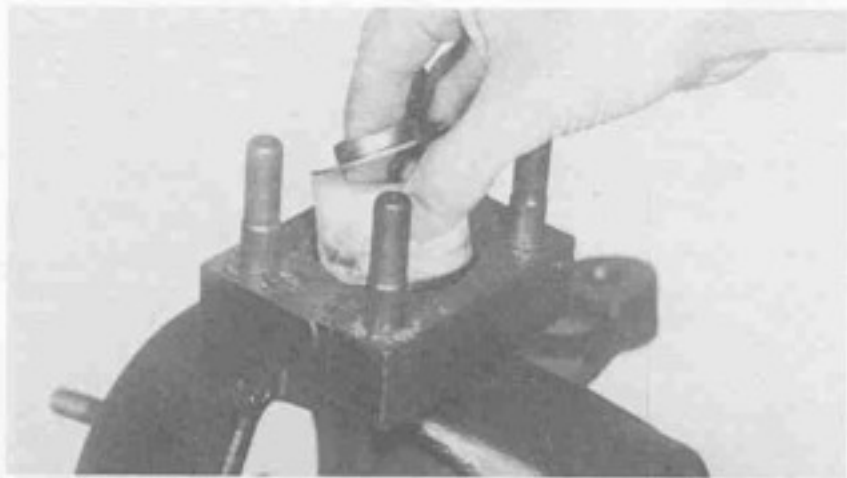

Figure 59 1019-59
Remove king pin tapered bushing, spring retainer, and knuckle from yoke. Remove king pin seal.

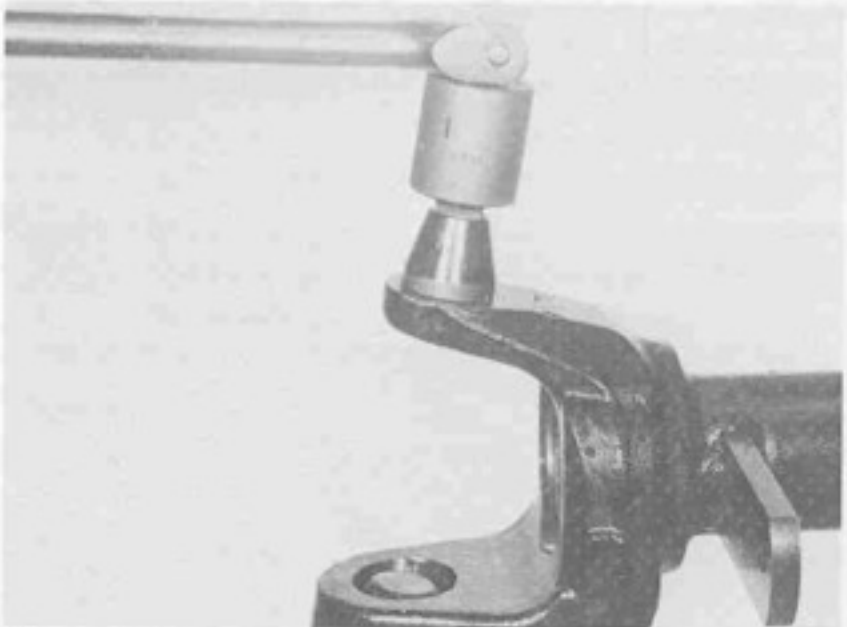

Figure 60 1019-60
Remove king pin as shown.
Tool: #D-192 King Pin Installer and Remover.



Figure 61 1019-61
Remove king pin bearing cup, cone, grease retainer, and seal all at the same time. Assemble and use tools exactly as shown in Figure 62. Discard seal and replace with new one at time of assembly. If grease retainer is damaged, replace with new one at time of assembly.

Tools: #D-141 Installer, #C-4171 Handle.

ASSEMBLY



Figure 62 1019-62
Assemble new grease retainer and king pin bearing cup.
Tools: #D-142 Installer, #C-4171 Handle.



Figure 63 1019-63
Fill the area in grease retainer with specified grease, grease bearing cone and install. Install new king pin bearing oil seal.

Tools: #D-194 Installer, #C-4171 Handle.

FRONT AXLE

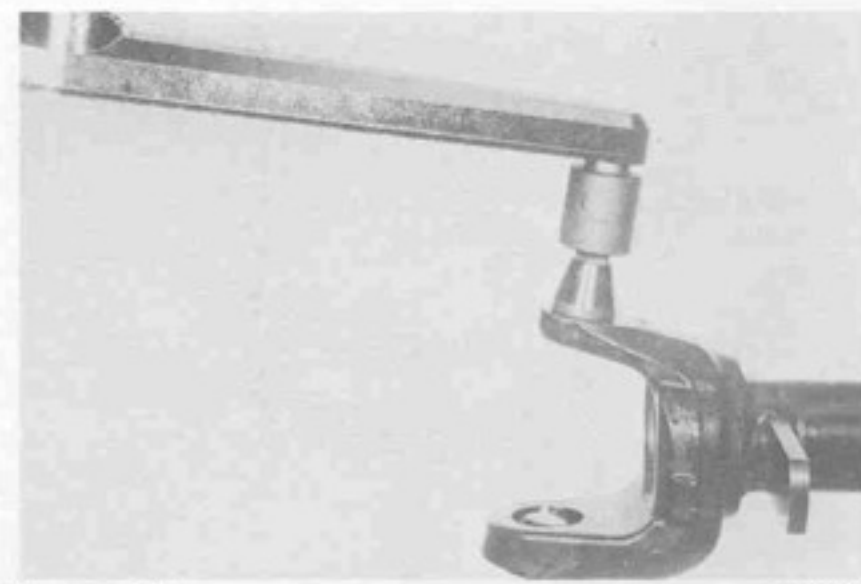

Figure 64 1019-64
Install king pin. Torque king pin to 500-600 Lb. Ft. (678-813 N·m).

Tools: #D-192 King Pin Installer and Remover, #DD-994 Torque Wrench.

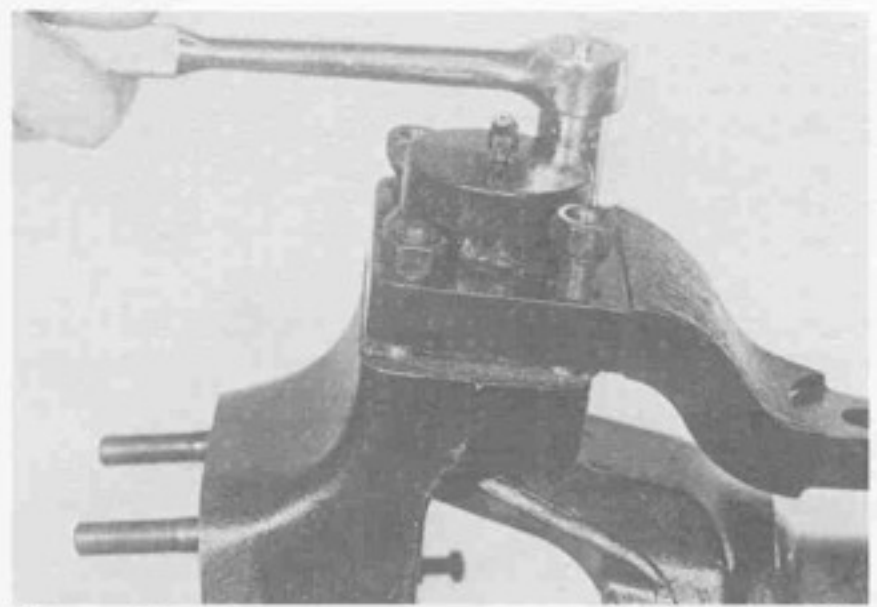

Figure 67 1019-67
Assemble spring retainer and compression spring on king pin bushing. Assemble steering arm, with new gasket, over four studs. Tighten nuts alternately and evenly. Torque nuts 70-90 Lb. Ft. (95-122 N·m).

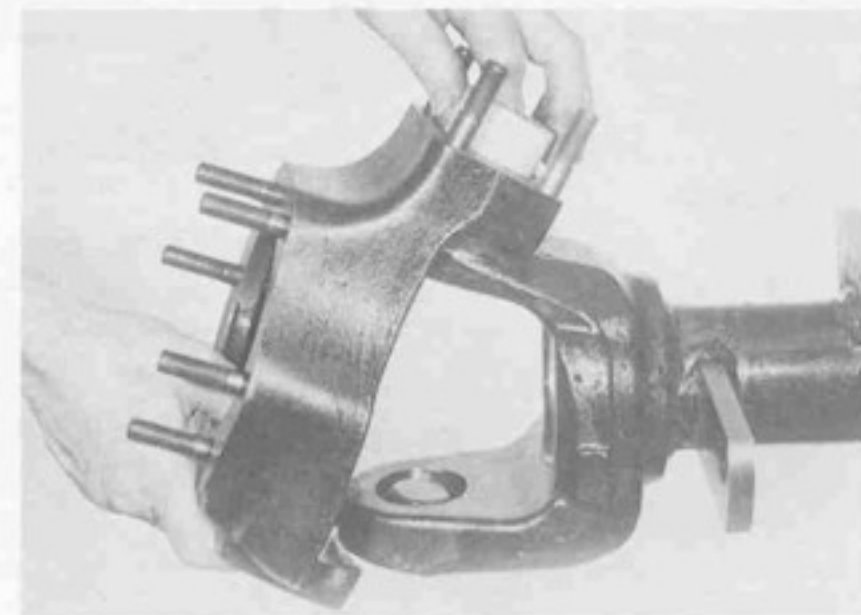

Figure 65 1019-65
Assemble felt seal to king pin, assemble knuckle assemble tapered bushing over king pin.

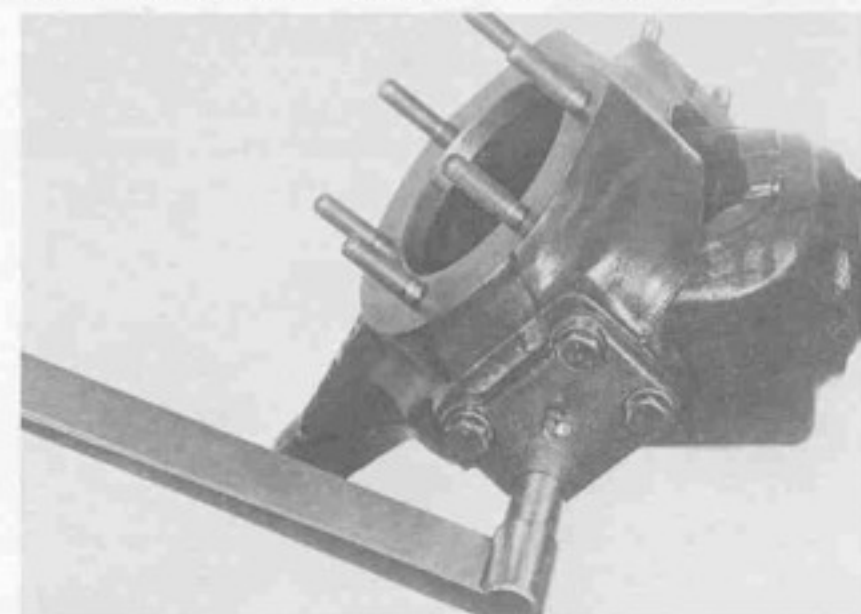

Figure 66 1019-66
Assemble bearing cap with four cap screws. Tighten cap screws alternately and evenly. Torque cap screws to 70-90 Lb. Ft. (95-122 N·m).

Tool: #C-524-A Torque Wrench.

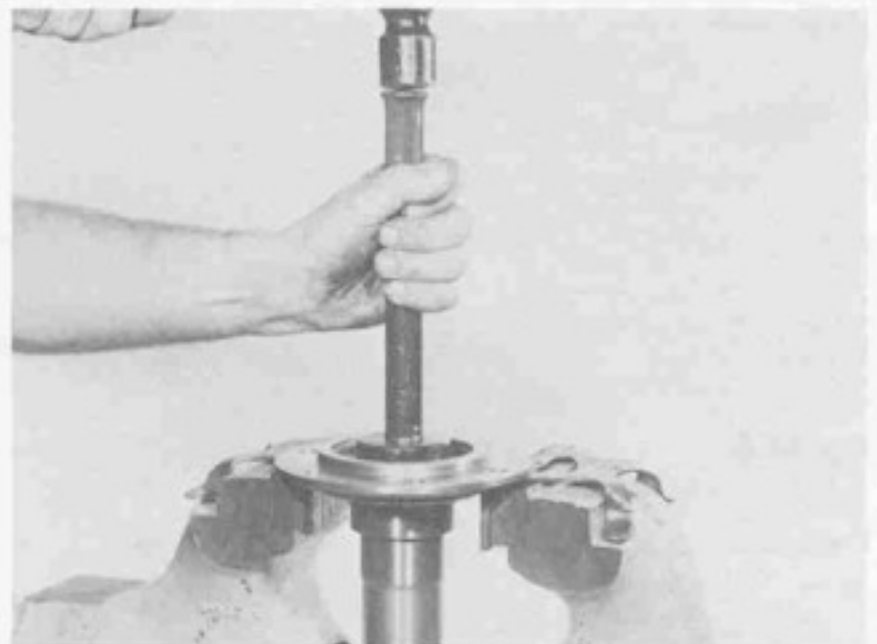

Figure 68 1019-68
Assemble new needle bearing into spindle.
Tools: #D-258 Installer, #C-4171 Handle.



Figure 69 1019-69
Assemble grease seal into spindle. The lip of the seal is to be directed away from the spindle.

FRONT AXLE

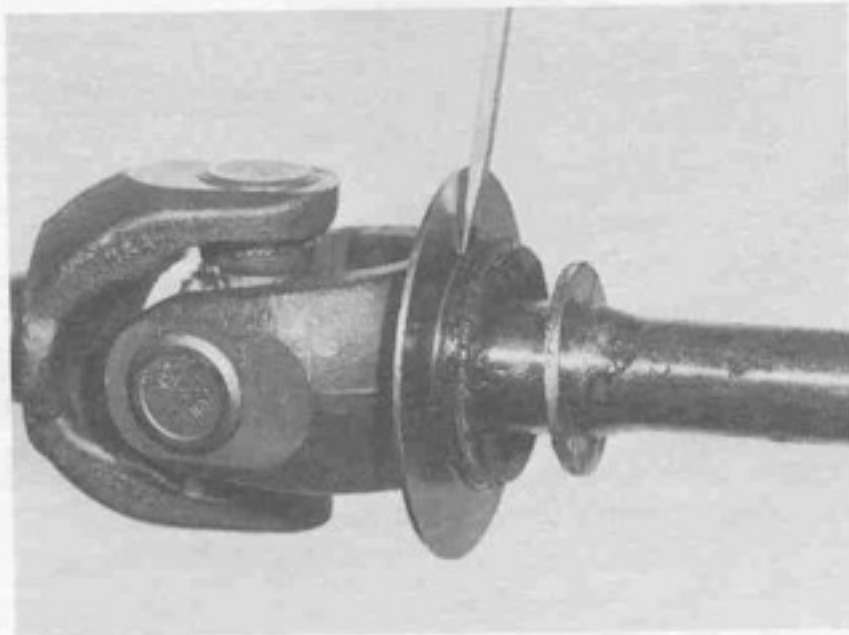

Figure 70 1019-70
Some front axles are equipped with a "V" seal, which is assembled to the axle shaft stone shield as shown. If seal is worn, remove and replace with a new one.

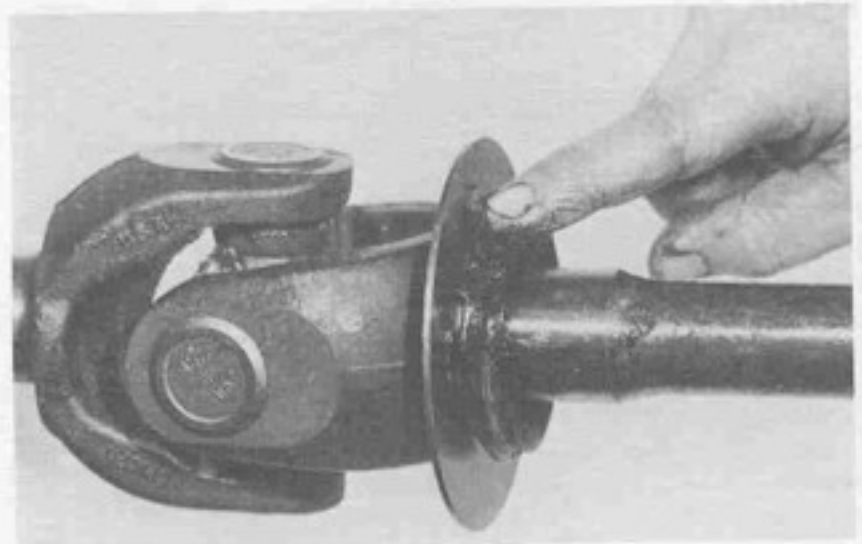

Figure 72 1019-72
Pack the area around the thrust face area of the shaft and seal full of grease. Also, fill the seal area of the spindle with grease.

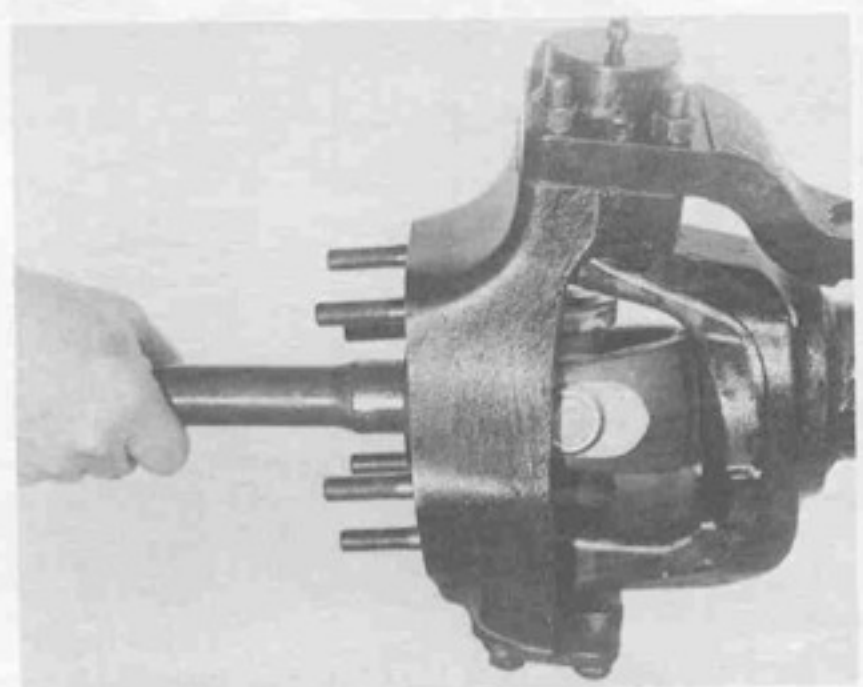

Figure 73 1019-73
Assemble axle shaft joint assembly into housing.



Figure 71 1019-71
Assemble new seal as shown. Lip of the seal is to be directed towards the spindle.

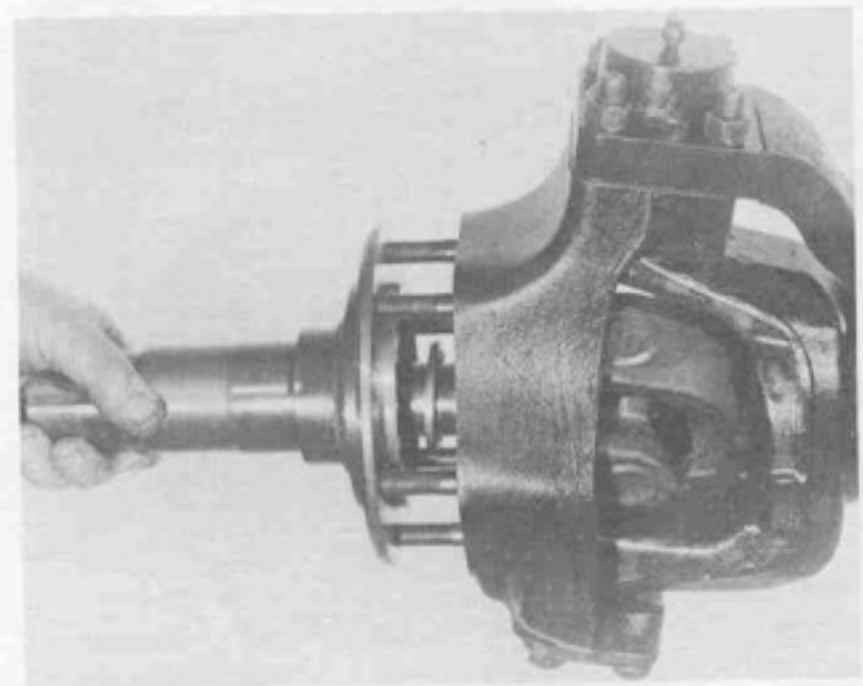

Figure 74 1019-74
Assemble new bronze spacer and spindle.

REAR AXLE

REAR AXLE

Unit wheel bearing design lubricated with hypoid lubricant.

NOTE

Unit wheel bearings that are dependent on lubrication from the hypoid gear lube in the axle housing, rather than grease, are not equipped with an inner axle shaft oil seal as shown in figure 75.

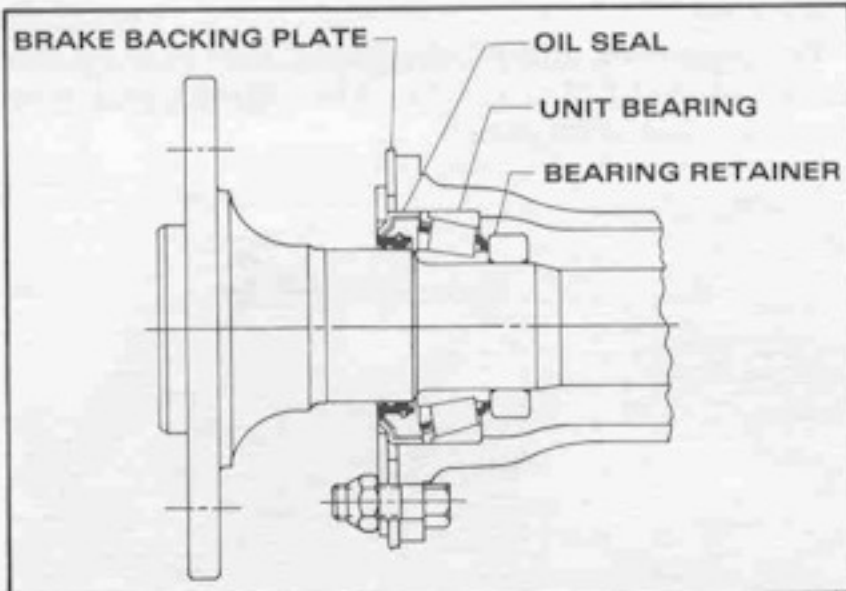

Figure 75 1019-75

Unit wheel bearing L/D without inner grease seal.

DISASSEMBLY



Figure 76 1019-76

After wheel is removed, remove brake drum.

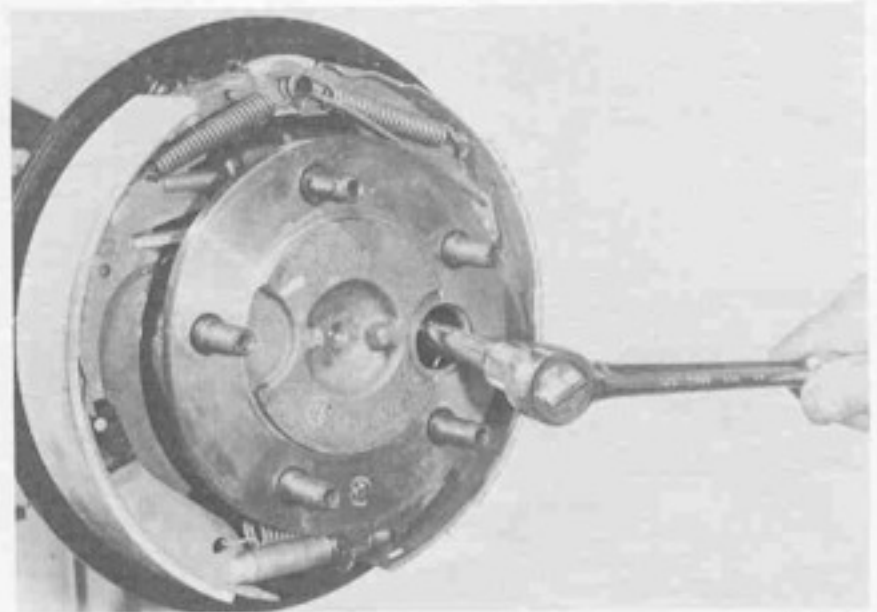

Figure 77 1019-77

Remove backing plate nuts which hold the brake backing plate to the axle housing. Discard nuts, replace with new ones at time of assembly. Nuts of torque prevailing design are not to be reused.

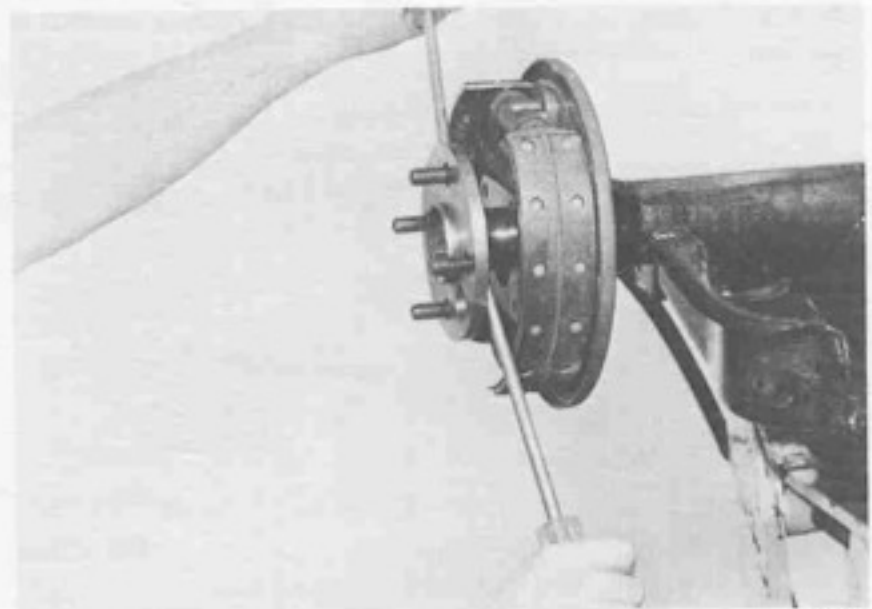

Figure 78 1019-78

Remove the axle shaft by pulling on the axle. It may be necessary to free the axle shaft by prying it loose with two screwdrivers or pry bars as shown.

NOTE

Backing plate can normally be wired to the frame, without loosening the hydraulic brake line connection at the wheel cylinder, if desired. Use caution to avoid damage to brake line.

REAR AXLE

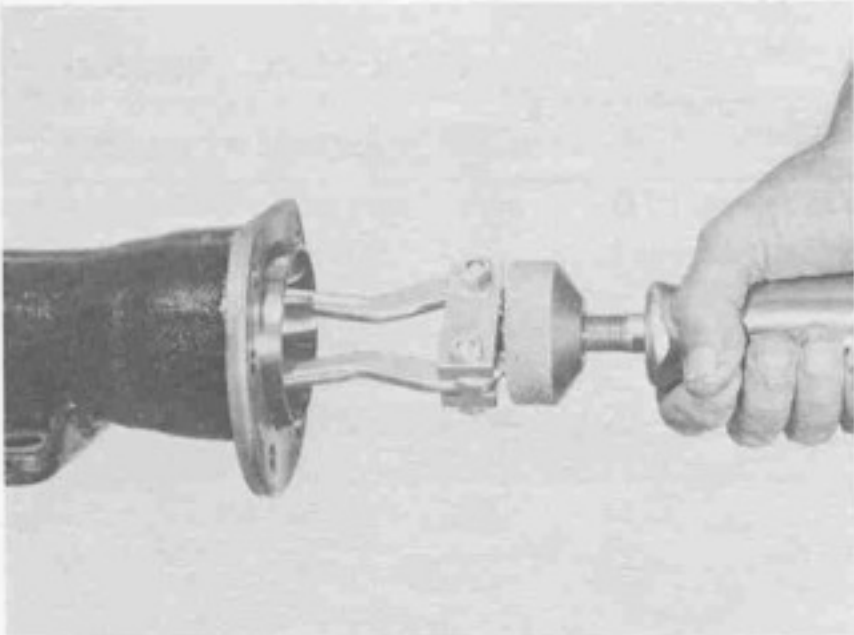

1019-79

Figure 79

The bearing cup will normally stay in place with the housing. To remove bearing cup, use puller as shown.

Tool: #D-131 Slide Hammer.

Cleaning, inspecting, and relubricating wheel unit bearing.

Clean bearing cup with any of the standard metal cleaning solvents. Inspect cup for any possible wear, nicks, etc.

The cone assembly can be cleaned in place on the axle shaft. Use any standard metal cleaning solvent and a stiff bristle brush to remove any dirt or any other contamination that might be present, then use compressed air. Air should be directed at the cone assembly so that it goes through the bearing from one end of the rollers to the other. It is important not to "Spin Dry" the bearing with compressed air. Spinning the dry bearing may score the raceways and rollers due to lack of lubricant.

Use a standard metal cleaning solvent to clean out the bearing bore in the housing. Wipe this area clean making sure it is free from dirt or any other contamination that might be present.

After the bearing has been inspected and approved for continued service, it must be lubricated prior to installation. The bearing must be lubricated by applying a small amount of the specified lube around the rollers of the bearing cone.

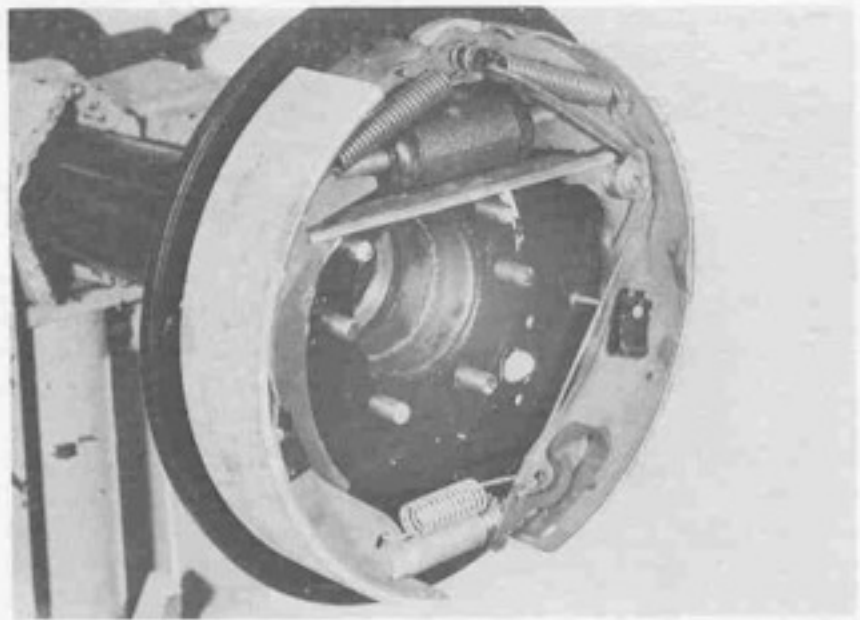

1019-80

Figure 80

Assemble backing plate bolts and backing plate assembly.

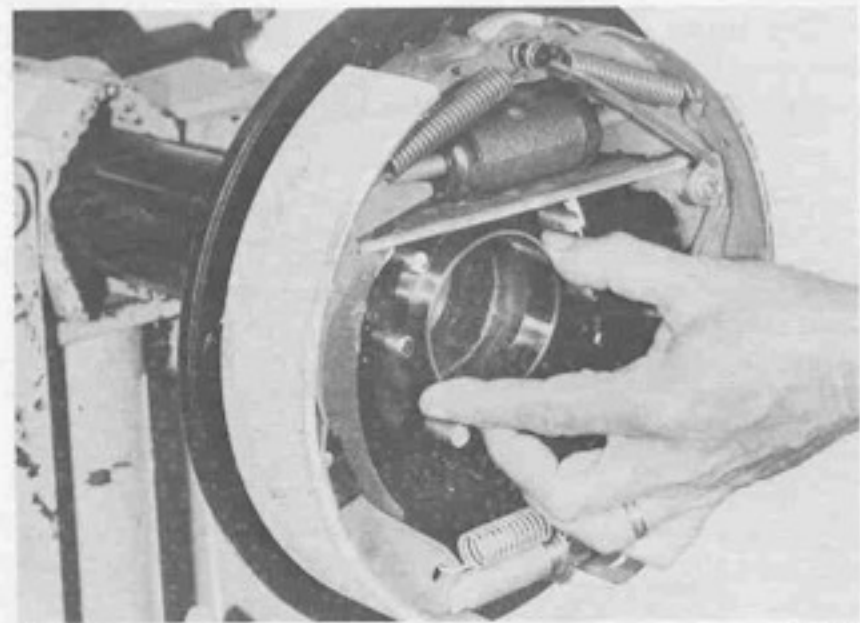

1019-81

Figure 81

Assemble bearing cup into bearing bore of the tube. Make sure the cup backface is against the bearing seat of the tube.



1019-82

Figure 82

Assemble axle shaft into housing. Care should be taken not to damage the bearing rollers.

Line up the holes of the retainer plate with the bolts, push axle shaft into the housing as far as possible.

REAR AXLE

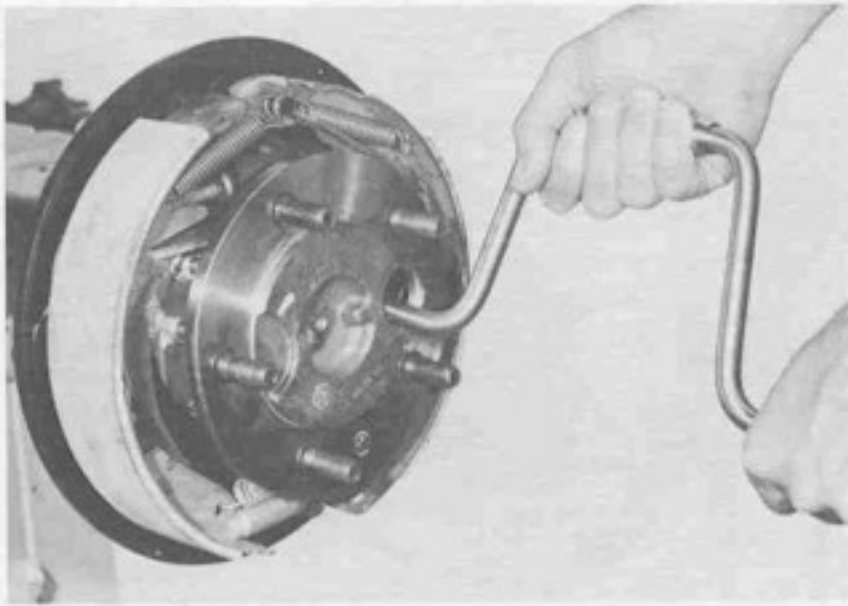

Figure 83 1019-83
Start nuts on backing plate bolts by hand. Use a speed wrench as shown and tighten to approximately 15 Lb. Ft. (20 N·m).

The units should be tightened in a manner that assures that the seal and cup rib ring are drawn evenly against the cup in the housing.

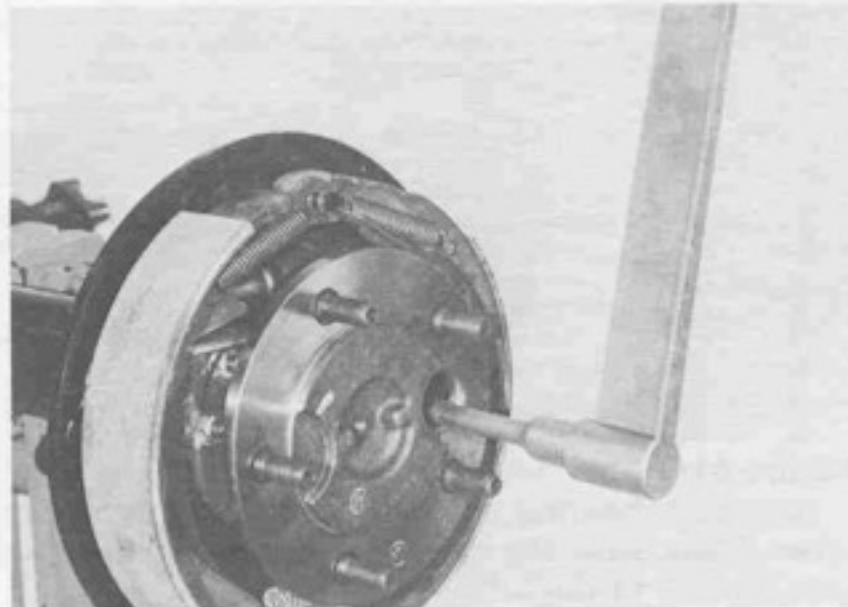

Figure 84 1019-84
Using a torque wrench as shown, torque nuts to 25-35 Lb. Ft. (34-47 N·m). Assemble brake drums, retainer nuts, wheels, etc.

Tool: #524-A Torque Wrench.

UNIT WHEEL BEARING DESIGN LUBRICATED WITH GREASE

NOTE

Unit wheel bearing that are dependent on grease for lubrication, rather than hypoid gear lube from the axle housing, are equipped with an inner axle shaft oil seal as shown in figure 85.

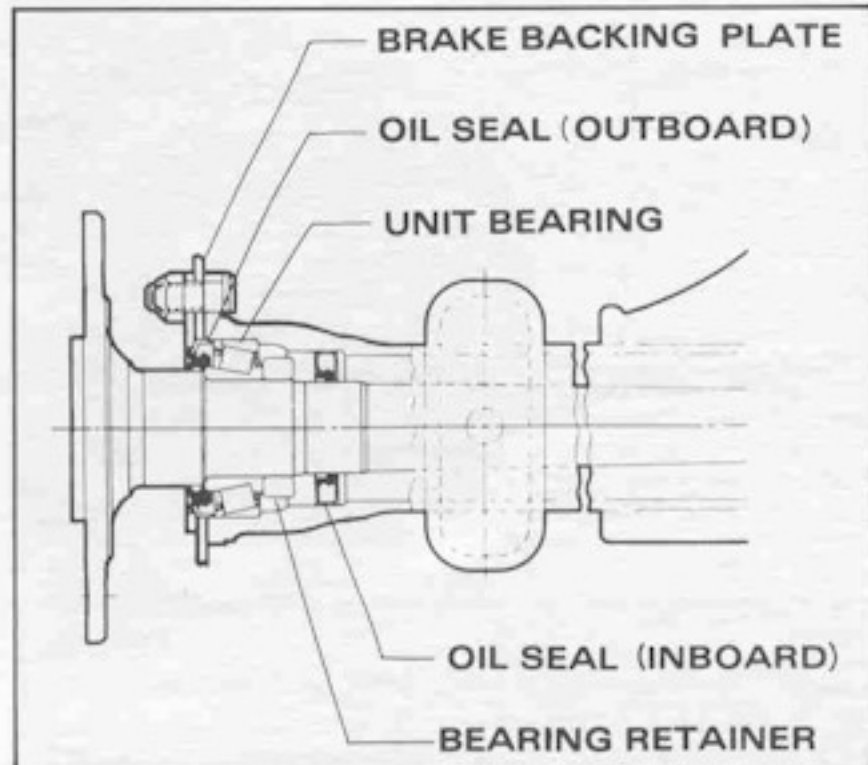

Figure 85 L/D 1019-85
Unit wheel bearing L/D with grease seal.

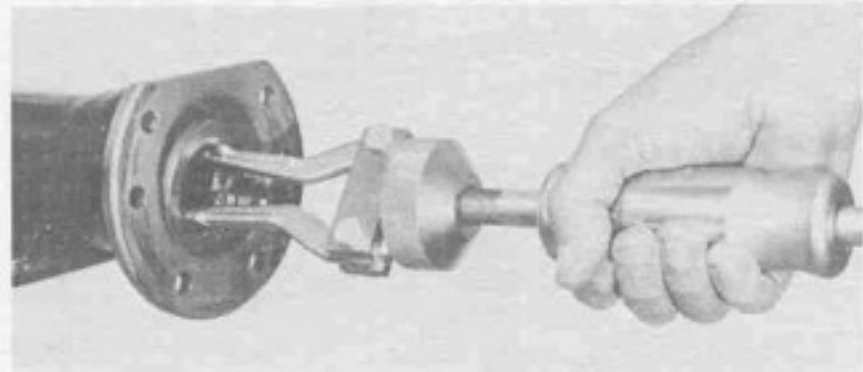

Figure 86 1019-86
Remove inner axle shaft seal using puller as shown.

Tool: #D-131 Slide Hammer.

Discard seal and replace with new one at time of assembly.

NOTE

Avoid contacting seals with cleaning solvent in cleaning operation.

CLEANING, INSPECTING, AND RELUBRICATING UNIT BEARINGS

Clean bearing cup with any of the standard metal cleaning solvents. Inspect cup for any possible wear, nicks, etc.

The cone assembly can be cleaned in place on the shaft. Use a standard metal cleaning solvent and a stiff bristle brush to loosen the old grease. To ensure removal of the old grease and any contamination that might be present, use compressed air. Air should be directed at the cone assembly so that it goes through the bearing from one end of the rollers to the other. It is important not to "Spin

REAR AXLE

Dry'' the bearing with compressed air. Spinning the dry bearing may score the raceways and rollers due to the lack of lubricant.

Use a standard metal cleaning solvent to clean out the bearing and oil seal bore in the housing. Wipe this area clean, making sure it is free from any old grease or other contamination that might be present.

After the bearing has been inspected and approved for continued service, it must be lubricated prior to installation.

The grease should be a good quality number 2 E.P. (Extreme Pressure) lithium soap, wheel bearing grease.

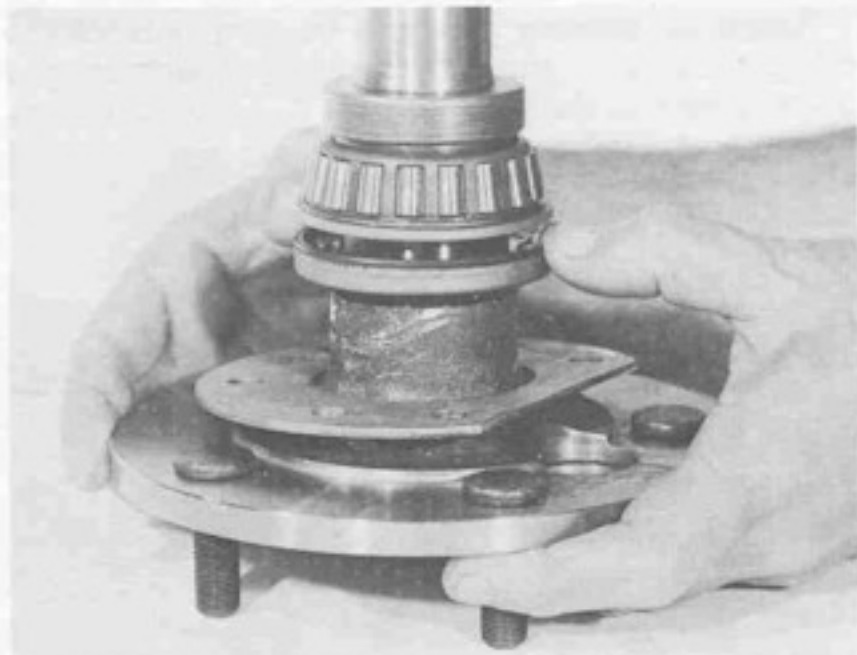

Figure 87 1019-87

Push seal and retainer away from the bearing to allow a cavity between the seal and bearing.



Figure 88 1019-88

Fill the area or cavity between the seal and bearing with the recommended grease.

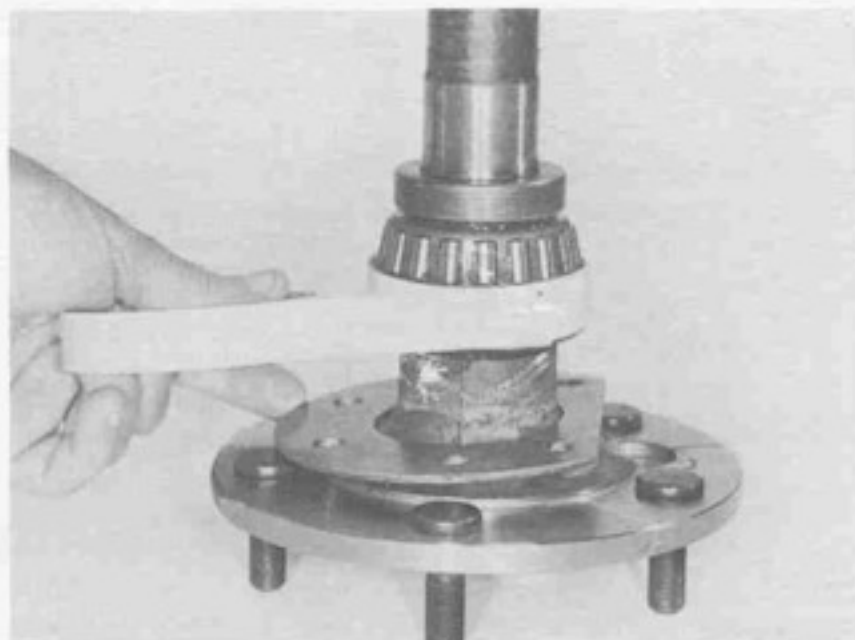

Figure 89 1019-89

After the cavity is full of grease, wrap tape completely around the rib ring and seal as shown to enclose the cavity.



Figure 90 1019-90

With tape still wrapped around the ring, push seal up until it contacts the rib ring. This will force the grease up through the rollers.

NOTE

If grease is not apparent on small end of rollers, repeat these steps until grease appears.

REAR AXLE

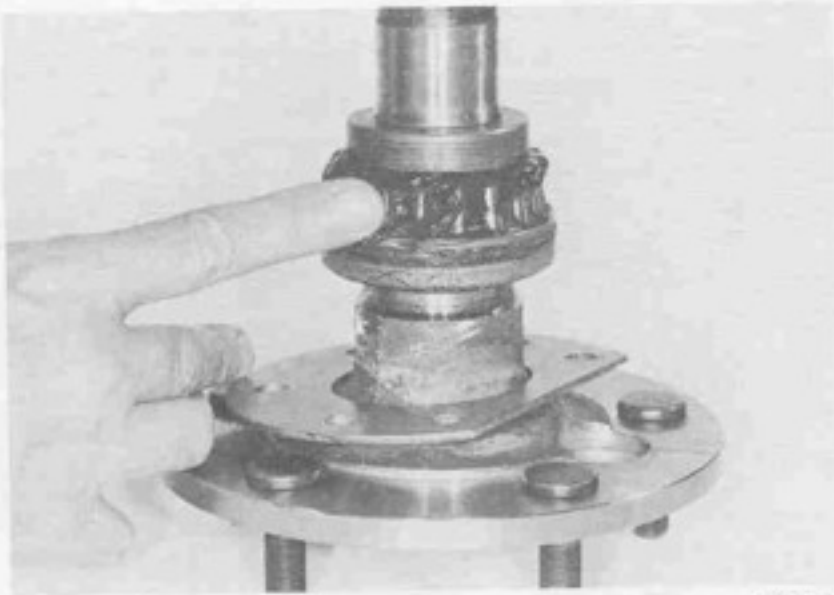

1019-91

Figure 91

Remove tape and wipe excess grease on roller bodies.



1019-94

Figure 94

Assemble bearing cup into bearing bore of the tube. Make sure the cup backface is against the bearing seat of the tube.

ASSEMBLY



1019-92

Figure 92

Assemble new grease seal into housing.
Tools: #C-4026A Seal Installer, #C-4171 Handle.
After seal has been assembled, grease lip of seal.

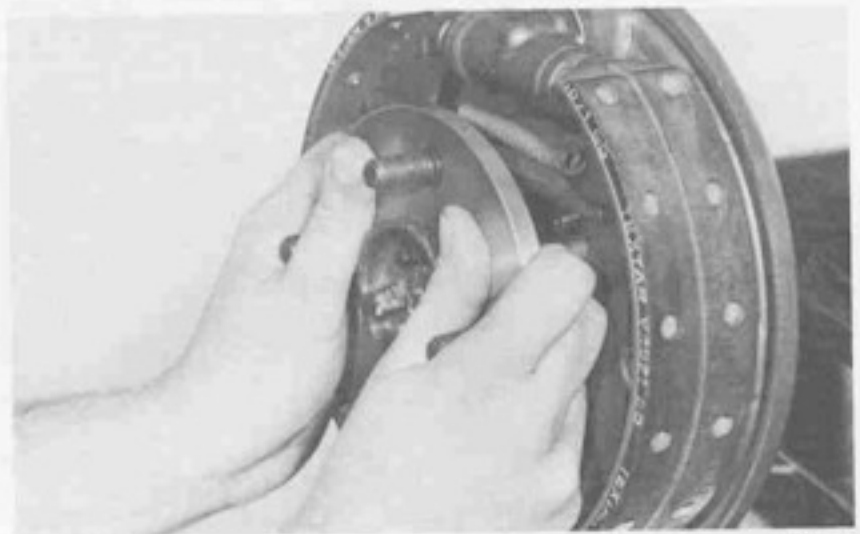

1019-95

Figure 95

Assemble axle shaft into housing. Care should be taken not to damage the seal lip and bearing rollers.
Line up the holes of the retainer plate with the bolts; push axle shaft into the housing as far as possible.

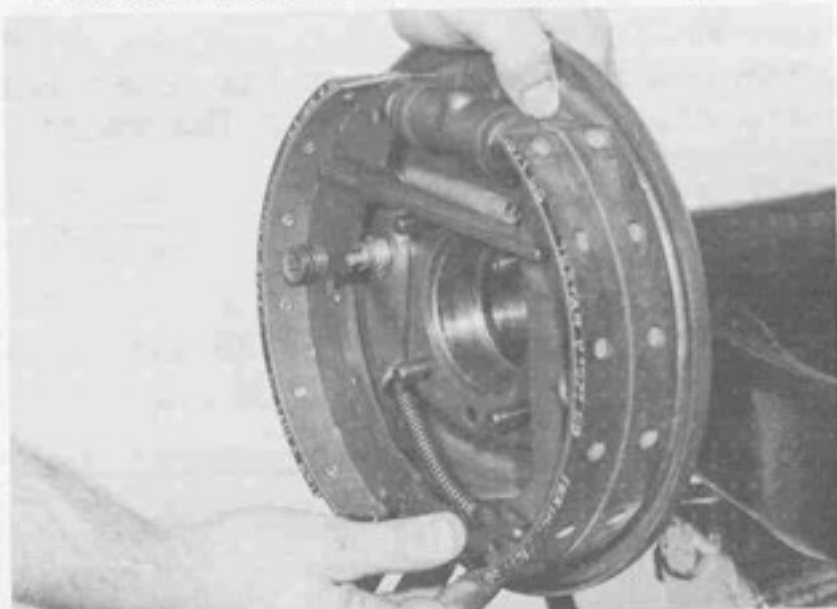

1019-93

Figure 93

Assemble backing plate bolts and backing plate assembly.

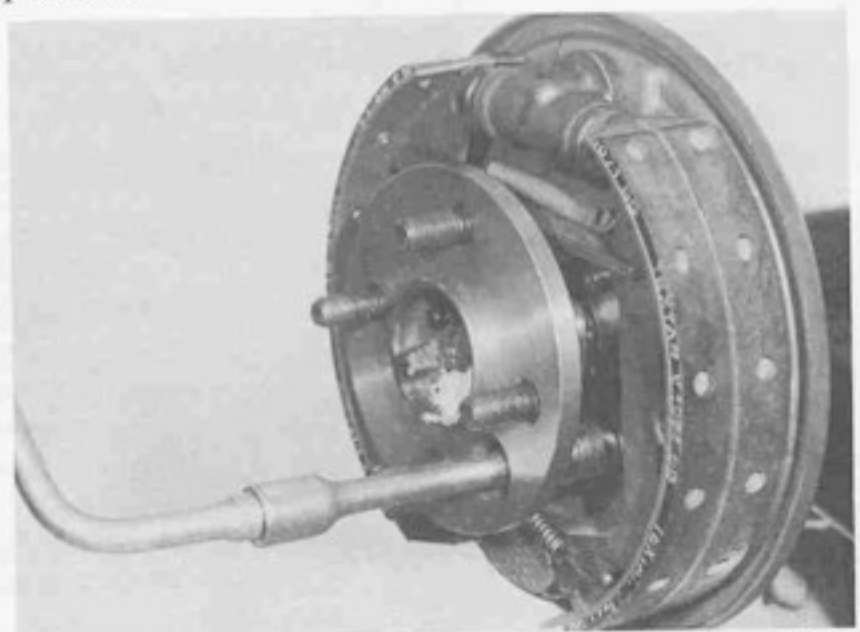

1019-96

Figure 96

Start nuts on backing plate by hand. Use a speed wrench as shown and tighten to snug fit.

REAR AXLE

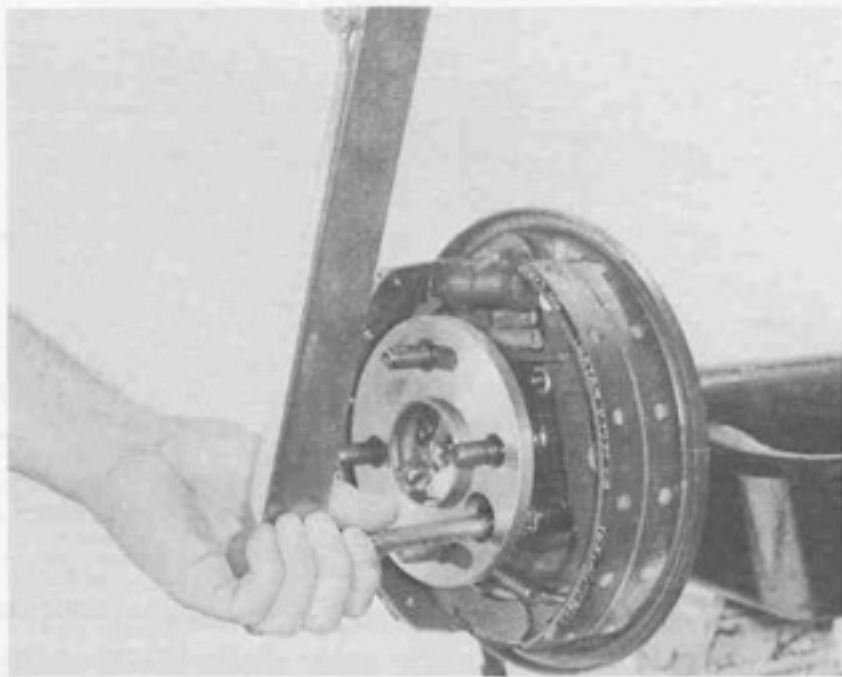

Figure 97

1019-97

Use a torque wrench and torque nuts to 25-35 Lb. Ft. (34-47 N·m).

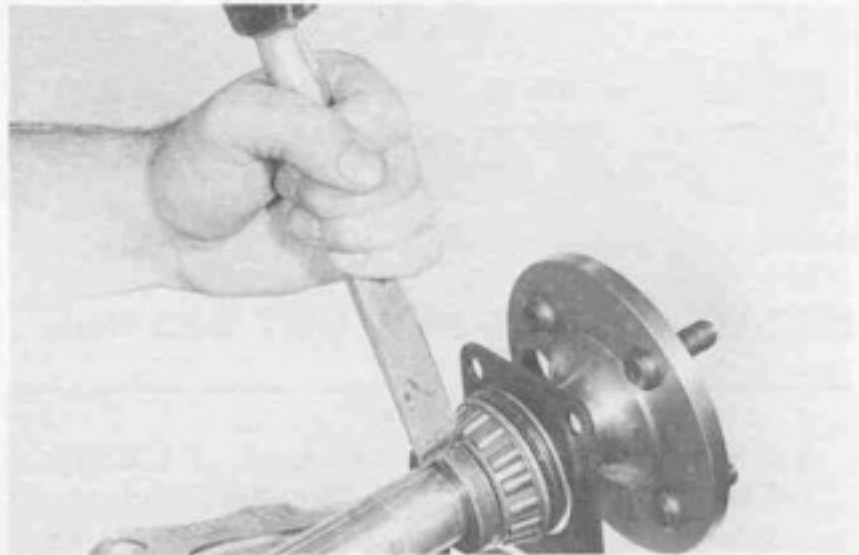

Figure 99

1019-99

After drilling the ring, use a chisel positioned across the hole and strike sharply to break the ring. Discard and replace with a new one at time of assembly.

REMOVAL OF UNIT BEARING FROM AXLE SHAFT

NOTE

To disassemble axle shaft from housing, follow the procedures illustrated in figures 75 thru 79.



Figure 98

1019-98

Place axle shaft in a vise. Drill a 1/4" (6.35 mm) hole in the outside of the retainer ring to a depth approximately three fourths the thickness of the ring. Do not drill all the way through the ring; the drill could damage the axle shaft.

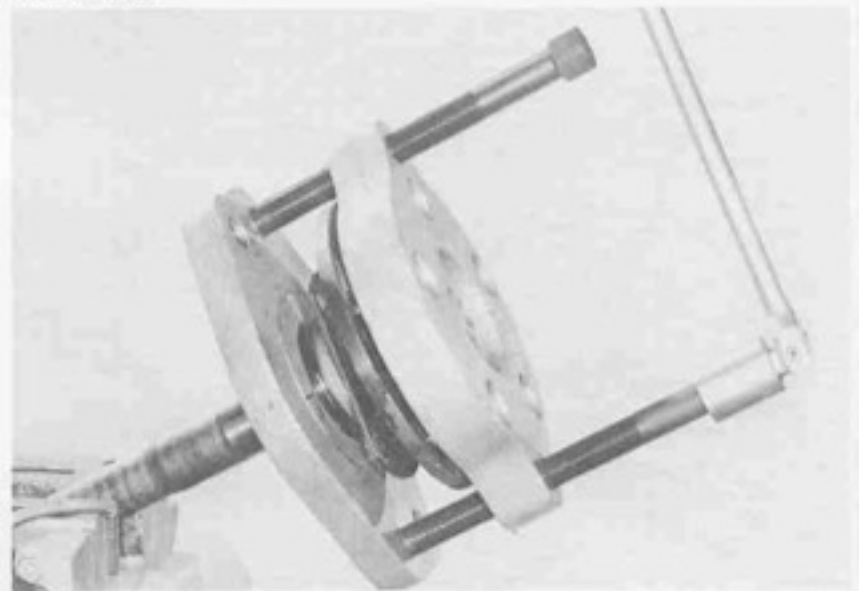

Figure 100

1019-100

Push retainer plate and seal towards flange of axle shaft. Install the flange plate to the flange of the axle shaft. Install bolts into flange plate. Slide forcing plate over the axle shaft. Install the adapters so they seat under the cup rib ring.

Gradually tighten the bolts until they are located in the dimples on the backside of the forcing plate.

Tools: #SP-5443-A Flange Plate, #SP-5017 Adapter Ring, #SP-5542-D Adapters, #SP-5026 Bolts.

Tighten bolts of tool alternately until bearing cone is removed from axle shaft. Be careful not to mark the machined surfaces of the axle shaft.

CAUTION

Do not heat or cut the bearing cone assembly with a torch to remove. Damage to the axle shaft will result.

Remove seal and retainer plate. Discard seal. Replace with new one at time of assembly.

Inspect retainer plate for possible distortion. If any portion of the retainer plate is damaged, it should be replaced. Inspect machined surfaces of the axle shaft, such as the seal and bearing diameters. Clean axle shaft, remove all nicks or burrs.

REAR AXLE

INSTALLATION OF NEW UNIT BEARING

NOTE

The retainer ring area of the shaft is 1.7727'' (45.01 mm) minimum in diameter, and the retainer ring inside diameter is 1.7675'' (44.88 mm) maximum, and therefore, should require some 6000 lb. (26688N) minimum press to seat the ring against the unit bearing.

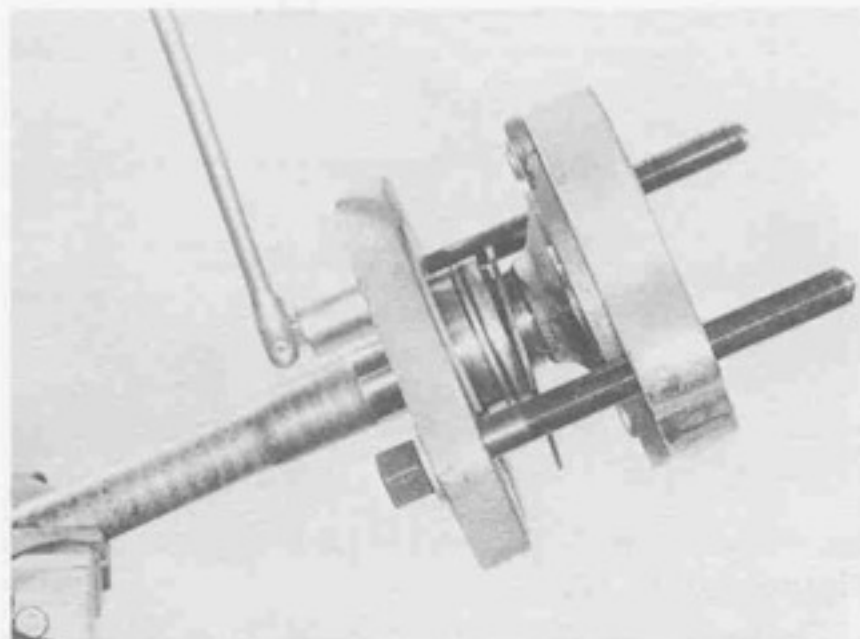

Figure 101

1019-101

Flange plate should still be assembled to the flange of the axle shaft. Remove bolts from flange plate. Assemble new retainer plate and oil seal.

The rubber portion of the oil seal, which extends beyond the casing has numbers bonded in the rubber. These numbers are to face toward the flange of the axle shaft.

Assemble new unit wheel bearing on axle shaft. Slide installing ring on axle shaft. Be sure to locate unit wheel bearing on the inside of the installing ring. Slide forcing plate on axle shaft and locate on installing ring. Install bolts and washer through the holes in the forcing plate and into flange plate.

Tools: #SP-5543-A Flange Plate, #SP-5017 Adapter Ring, #SP-5440 Adapter Plate Installer, #SP-5026 Bolts, #SP-3020 Washers.

Tighten bolts alternately and evenly, making sure bearing is not cocked on axle shaft. Continue until wheel bearing is seated. To make sure bearing is seated use a .0015'' (.0381 mm) feeler gage between bearing seat and bearing. If gage enters, force bearing further on the axle shaft, until gage does not enter.

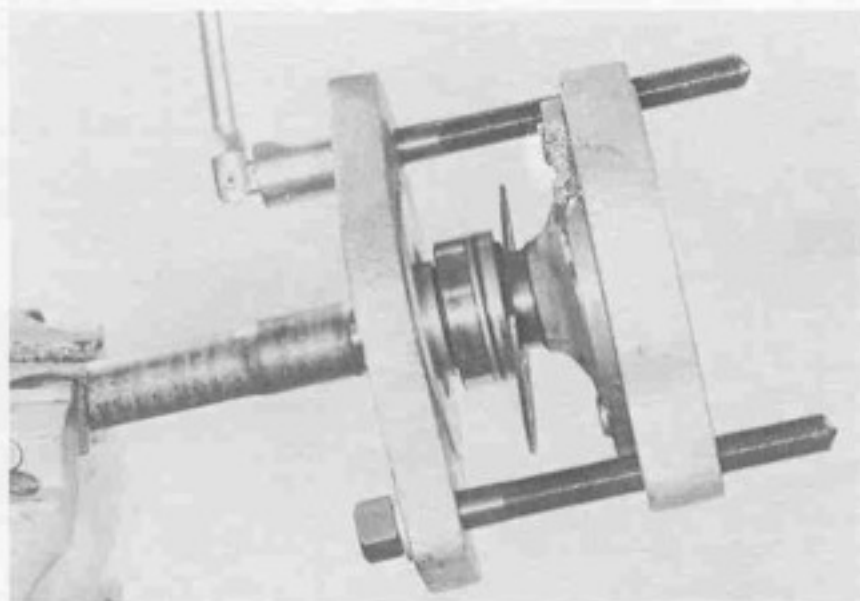

Figure 102

1019-102

Install retainer ring on axle shaft. Follow the same procedures in figure 101 to assemble the retainer ring.

Use a .0015'' (.0381 mm) feeler gage between the bearing and retainer ring to be sure that the retainer ring is seated. At least one point should exist, where the gage will not enter between the retainer ring and bearing. If gage enters completely around the diameter, retainer ring must be forced onto the axle shaft.

To assemble axle shaft assembly into housing, follow steps as illustrated in figure 82 through 84.

LUBRICATING NEW UNIT BEARING WITH GREASE

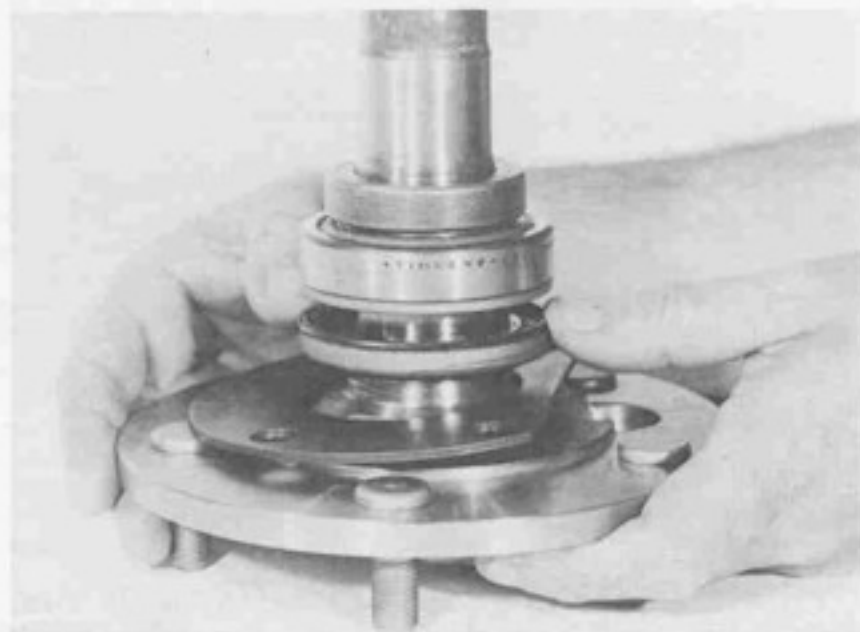

Figure 103

1019-103

Push seal and retainer away from bearing to allow a cavity between the seal and bearing.

REAR AXLE

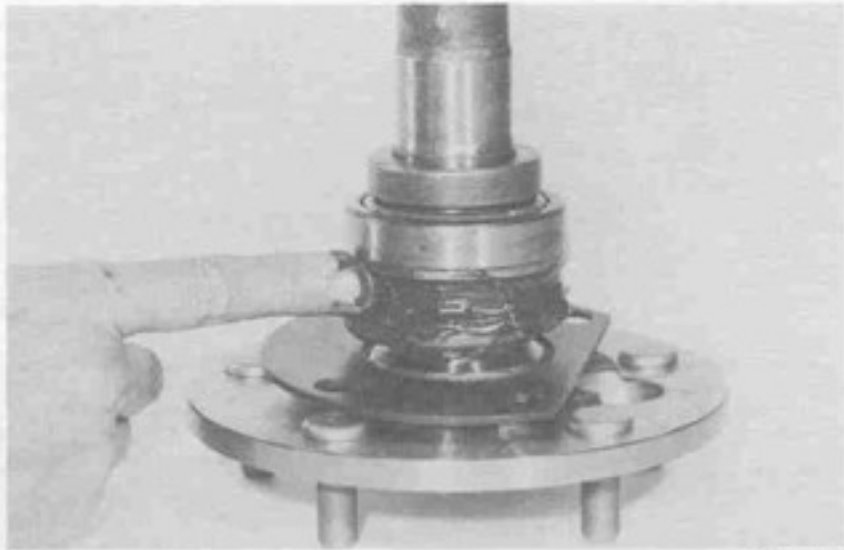

Figure 104

1019-104

Fill cavity with a good quality #2 E.P. (Extreme Pressure) lithium soap, wheel bearing grease.



Figure 105

1019-105

After cavity is full of grease, wrap tape completely around rib ring, and seal to enclose the cavity.

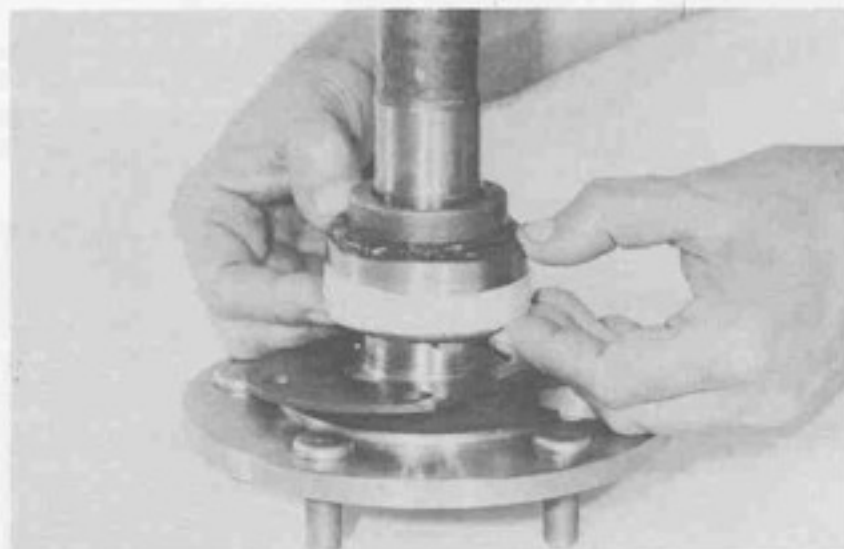

Figure 106

1019-106

Push seal towards the bearing until it contacts the rib ring. This will force the grease between the rollers and cup.

NOTE

If grease is not apparent on the small ends of the rollers, repeat the same steps until grease is evident between the small end of the roller and cup. Remove tape.

REAR AXLE SEMI-FLOAT SHAFT RIDING BEARING DESIGN LUBRICATED WITH HYPOID LUBRICANT

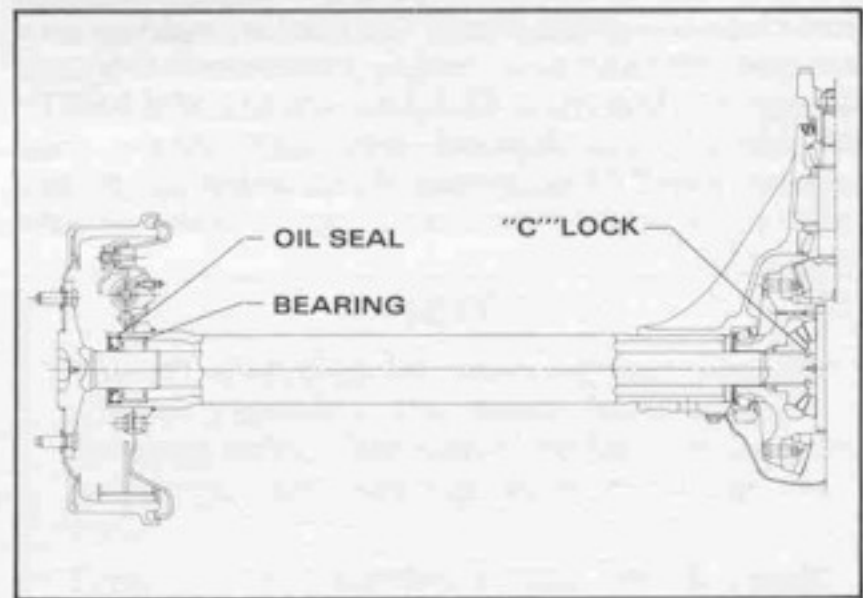

Figure 107

1019-107

(Picture of Shaft Riding Bearing Design)

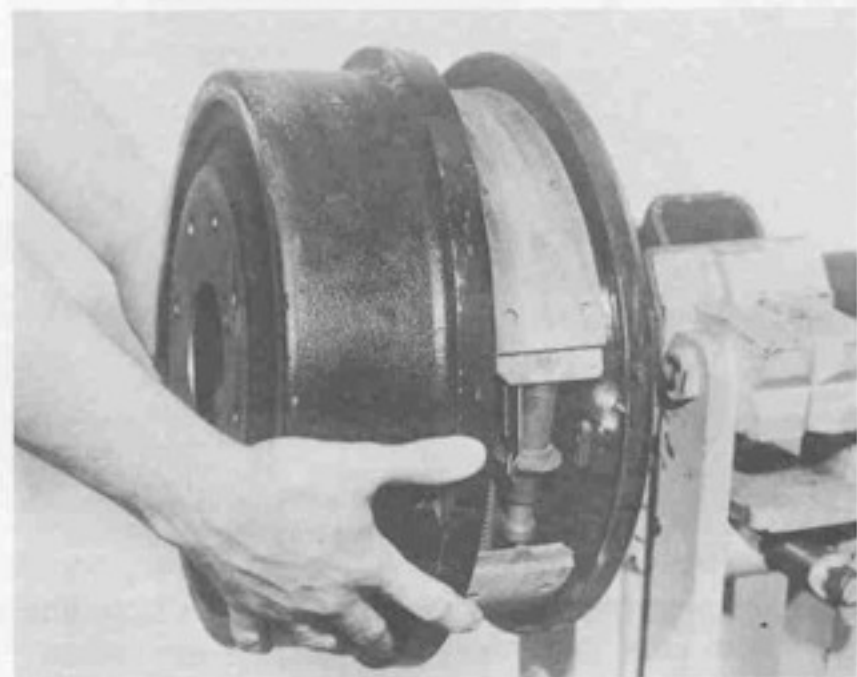

Figure 108

1019-108

After wheel is removed, remove brake drum.

Remove drain plug and drain lubricant. If there is no drain plug in the carrier, the lube will drain out as the cover plate is removed.

REAR AXLE

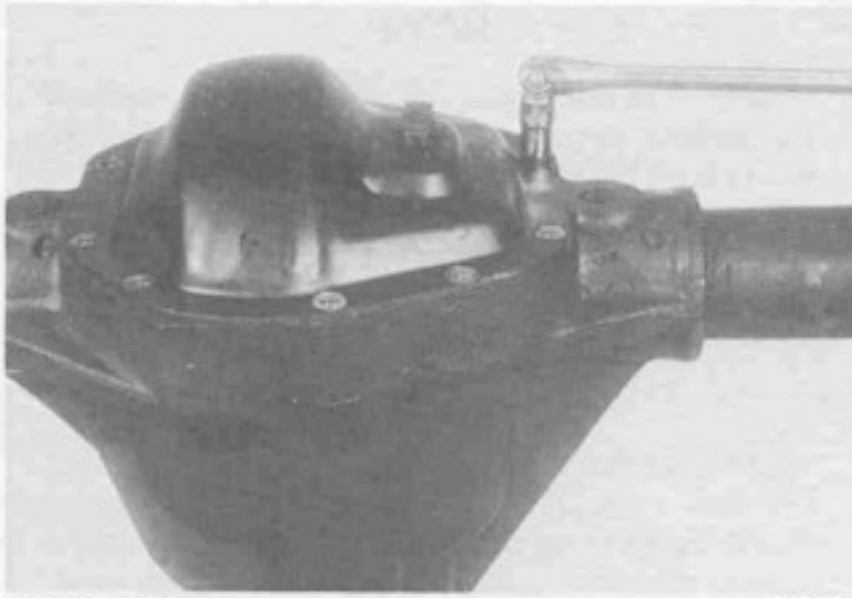

Figure 109

1019-109

Remove cover plate screws, cover plate, and cover plate gasket. Discard old gasket. Tip carrier to allow lube to drain completely. Also during this time clean the cover face of the carrier, making sure it is free from any nicks and any particles left by the old gasket. **DO NOT USE CLEANING SOLVENTS OF ANY TYPE.** Use of cleaning solvents may prevent the "RTV" sealer from adhering to the cover plate and carrier, resulting in leaks of axle lubricant.

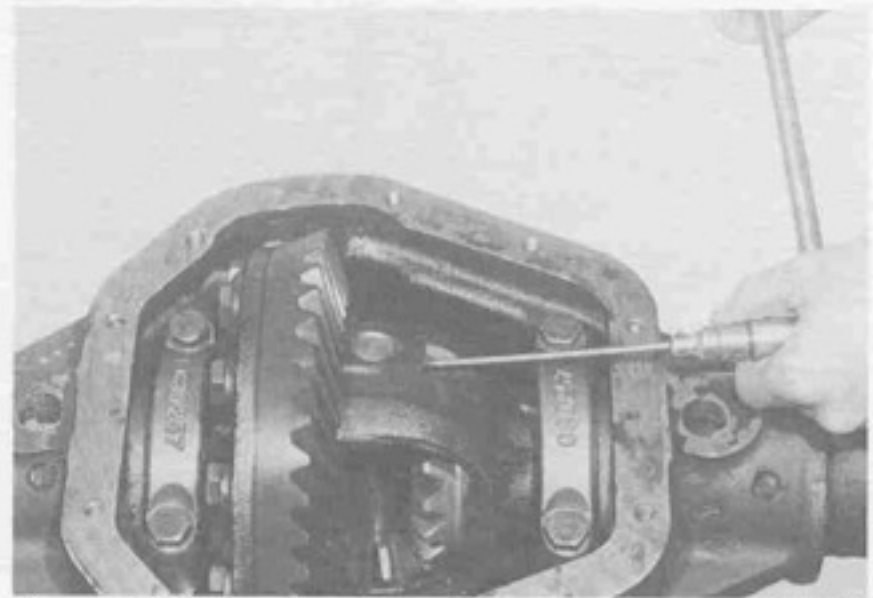

Figure 111

1019-111

Remove the differential pinion shaft lock screw as shown in Figure 111.

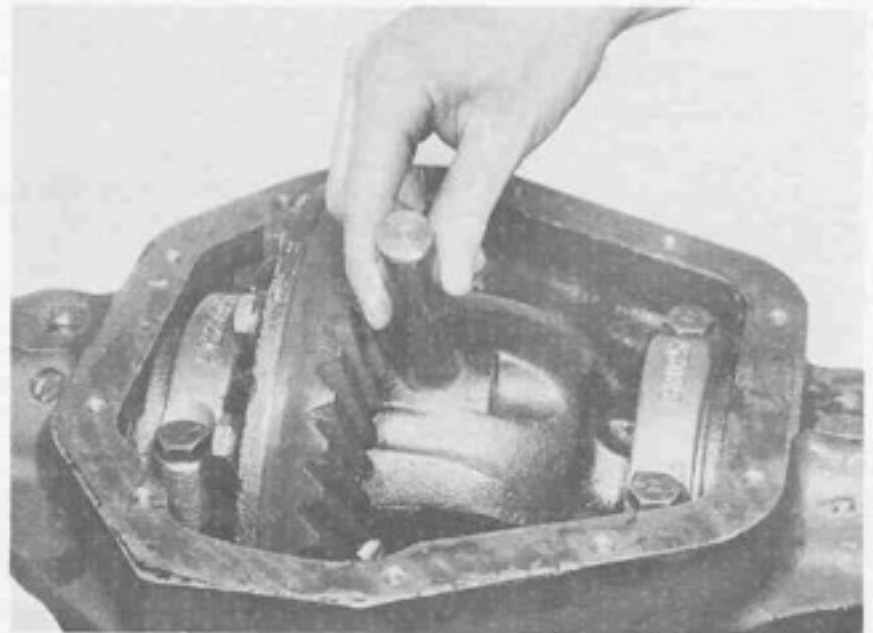

Figure 112

1019-112

Remove the differential pinion mate shaft.

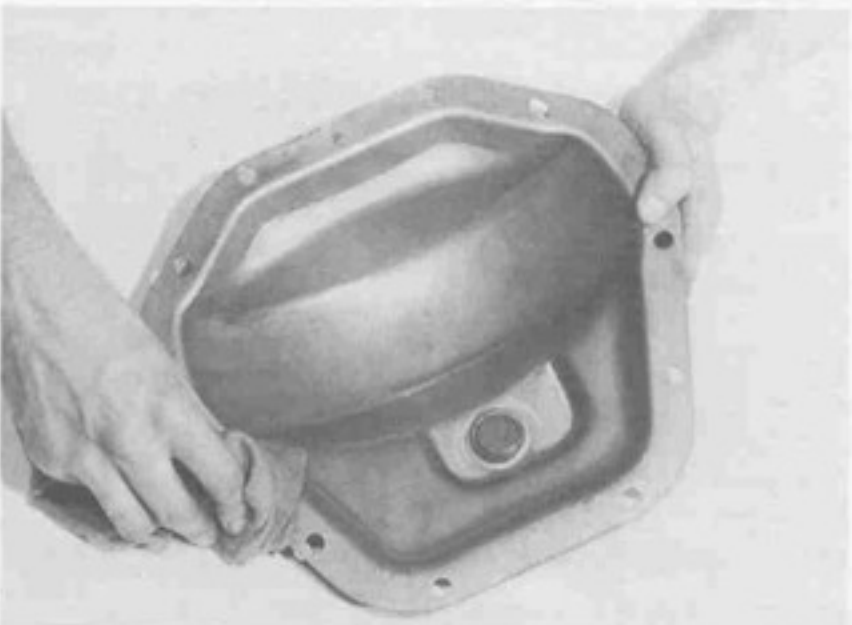

Figure 110

1019-110

Clean cover plate, making sure it is free from any nicks and any particles left by the old gasket material. Use a clean rag or a blunt tool for removing remaining gasket material. **DO NOT USE CLEANING SOLVENTS OF ANY TYPE.** Use of cleaning solvents may prevent the "RTV" sealer from adhering to the cover plate and carrier, resulting in leaks of axle lubricant.

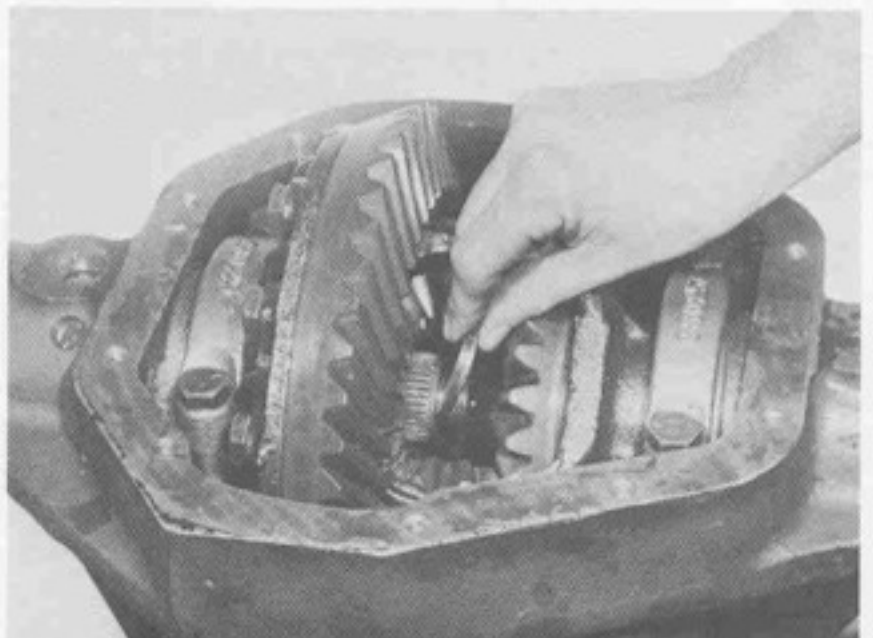

Figure 113

1019-113

Push flange end of axle shafts toward center of vehicle and remove the "C" locks from button end of both shafts.

REAR AXLE

OIL SEAL AND WHEEL BEARING REPLACEMENT

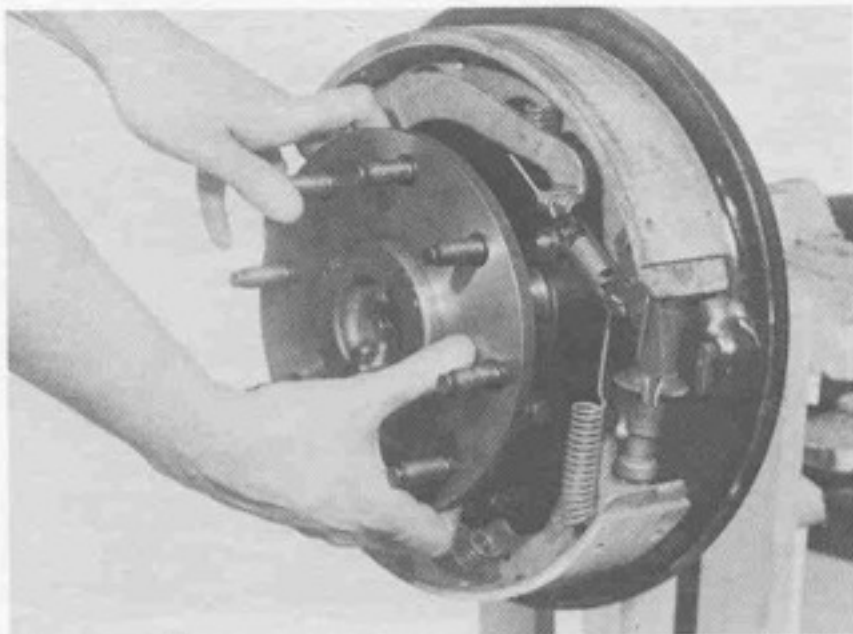

Figure 114

1019-114

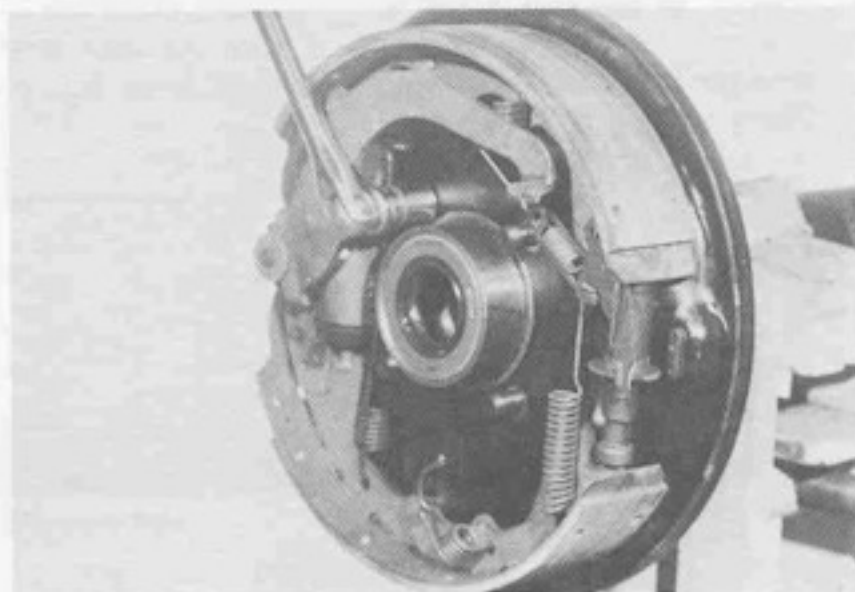

Figure 116

1019-116

Remove the backing plate nuts and bolts which hold the brake backing plate to the axle housing, (3) places. Discard nuts, replace with new ones at time of assembly. Nuts of torque prevailing design are not to be reused. Do not remove brake backing plate.

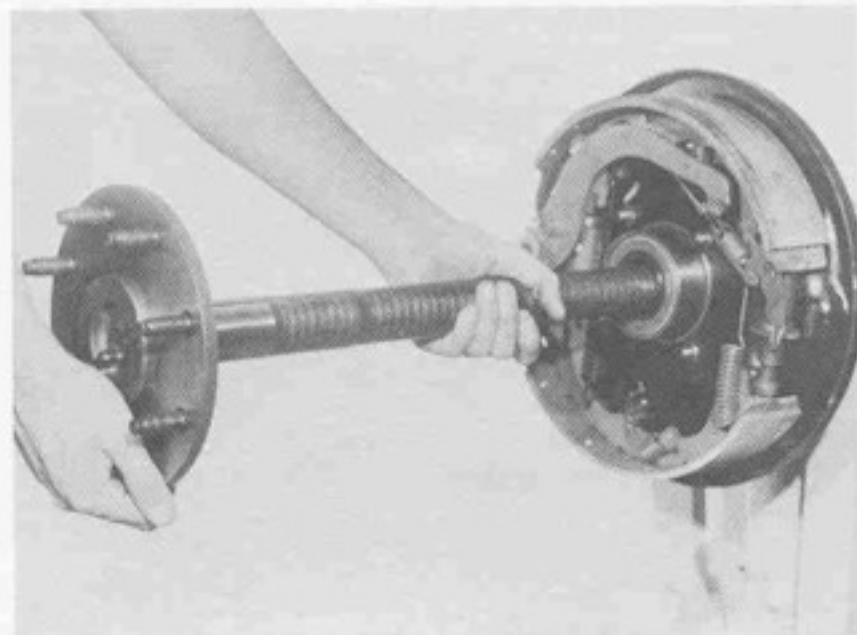

Figure 115

1019-115

Remove the axle shafts from the housing, being careful not to damage the oil seals, as shown in Figures 114 and 115.

NOTE

The oil seal may be removed and installed without removing the brake backing plate, nuts and bolts. Care should be taken so as not to damage the bearing upon removing the seal.

Tools: #C-4171 Handle, #D-233 Seal Installer, Seal Remover (screwdriver or other similar tool).

CAUTION

When removing the axle shafts, be careful not to rotate the differential side gears. This will cause the pinion mate gears and thrust washers to turn to the opening of the case and drop out.

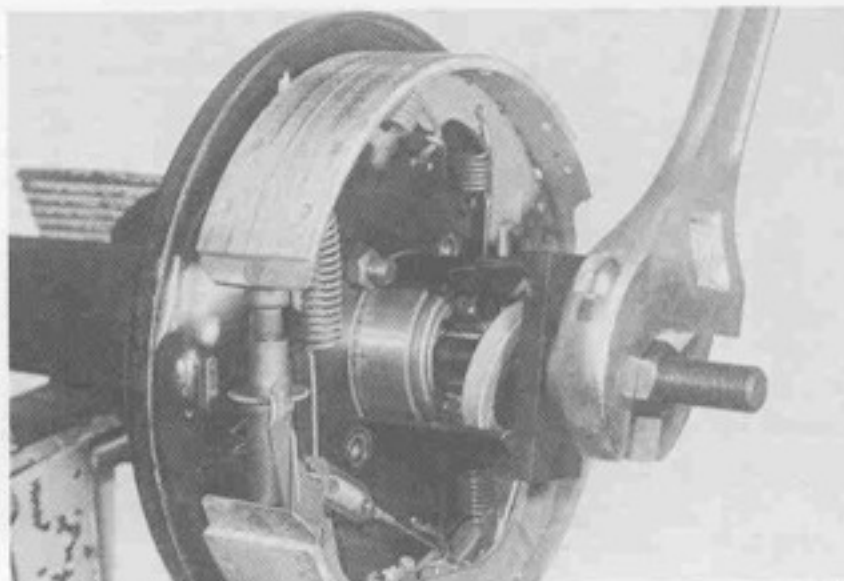

Figure 117

1019-117

Remove the wheel bearing and oil seal as shown. Discard old seal and bearing.

Tool: #D-232-1 Bearing Remover.

Use a standard metal cleaning solvent to clean out the bearing bore in the housing. Wipe this area clean, making sure it is free from dirt or any other contamination that might be present.

NOTE

The bearing bore must be free from nicks and burrs. Wipe the bore with emery cloth to assure a smooth surface. Clean bore out with a standard metal cleaning solvent. If bore has burrs or spalled areas and a new bearing is installed, it may lead to early fatiguing.

AXLE SHAFT AND WHEEL BEARING/ OIL SEAL ASSEMBLY

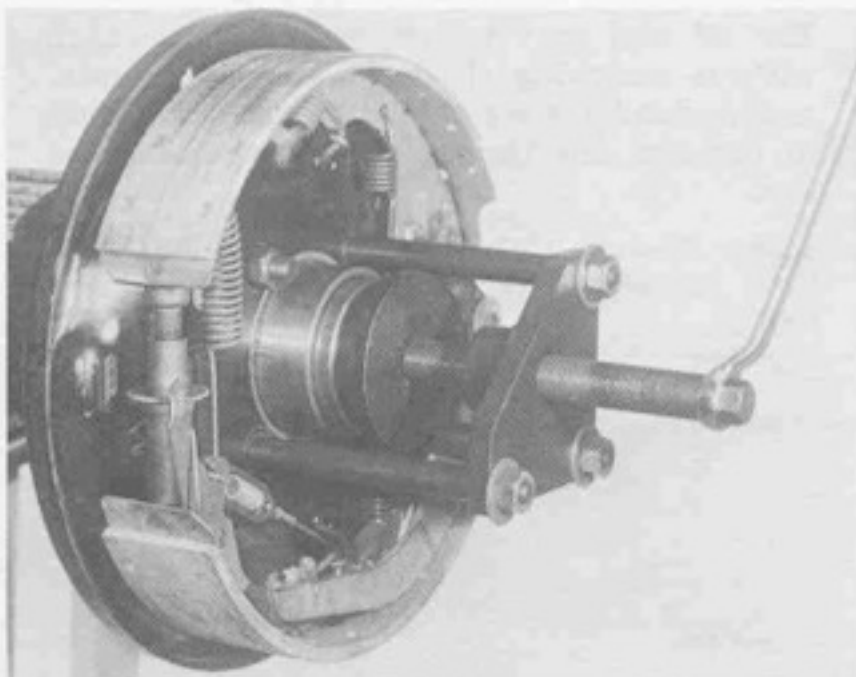

Figure 118

1019-118

Assemble bearing assembly into bearing bore of the tube as shown. Differential lube should be placed on the bearing for easier assembly and for the possible prevention of scoring the tube bore. The tool will stop against the tube end when bearing is seated to the proper depth

Tools: #D-247 Installer Press, #D-248 Bearing Installer.

CAUTION

DO NOT DRIVE THE BEARING INTO TUBE BORE WITH A BEARING DRIVER, AS DAMAGE TO THE BEARING MAY OCCUR.

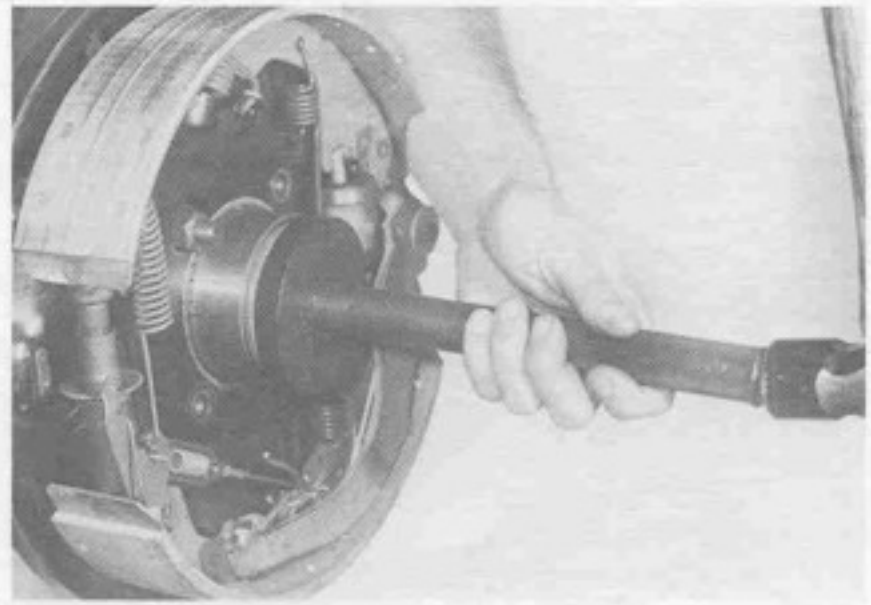

Figure 119

1019-119

Assemble new oil seal into housing as shown. Tool will stop against tube end when oil seal is seated to the proper depth.

Tools: #C-4171 Handle, #D-233 Seal Installer.

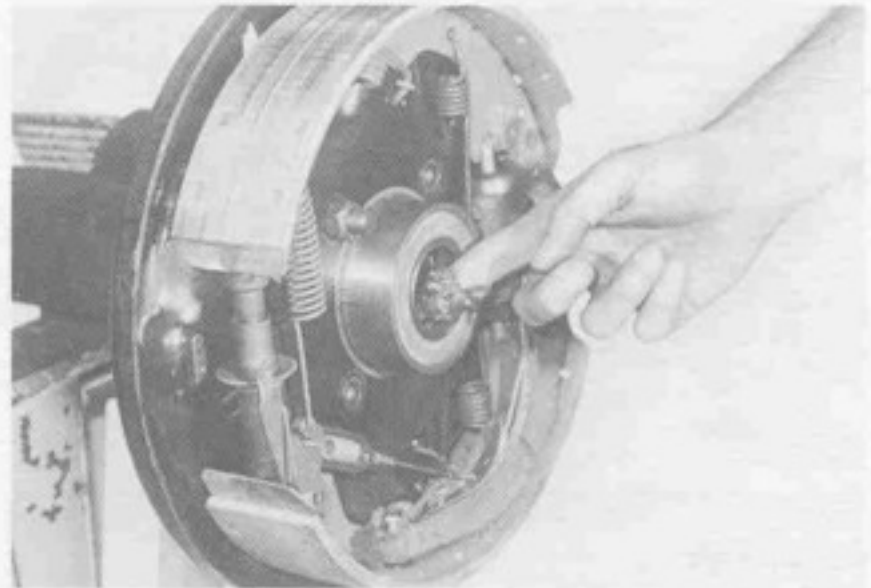

Figure 120

1019-120

Lubricate cavity between seal lips and lubricate new bearing with a good quality number 2 E.P. (Extreme Pressure), lithium soap, wheel bearing grease.

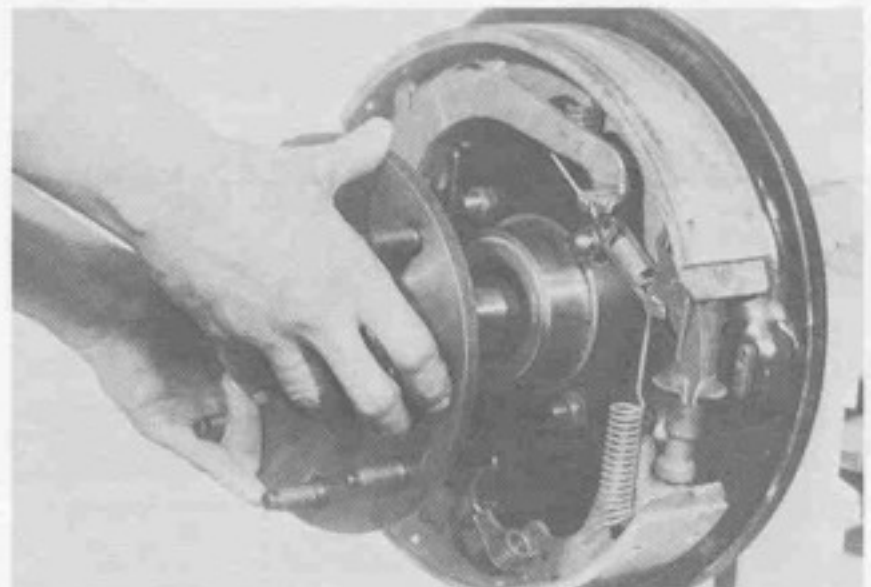

Figure 121

1019-121

Assemble axle shaft into housing. Care should be taken not to damage the seal lip and bearing rollers, and that the shaft spline engages with splines of differential side gears. Do not rotate side gears.

REAR AXLE

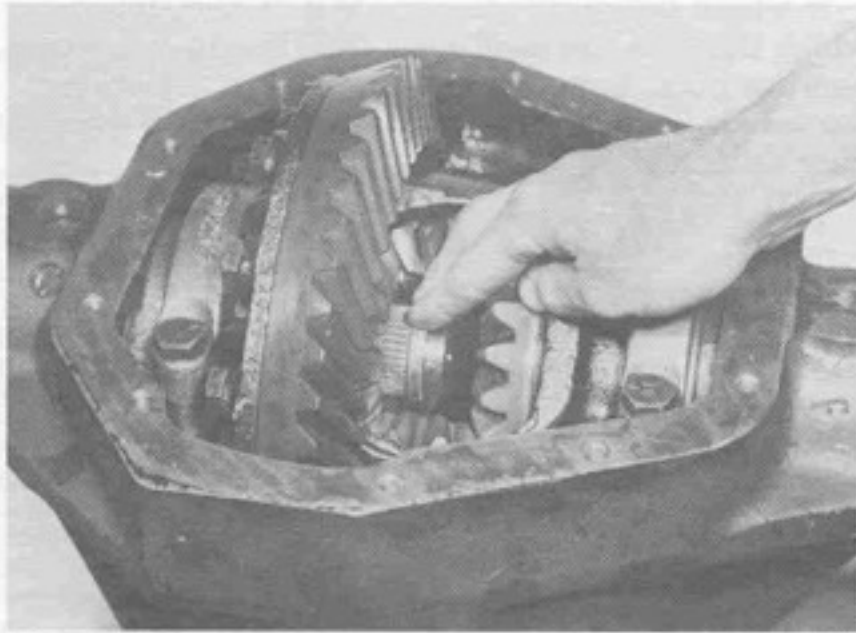

Figure 122

1019-122

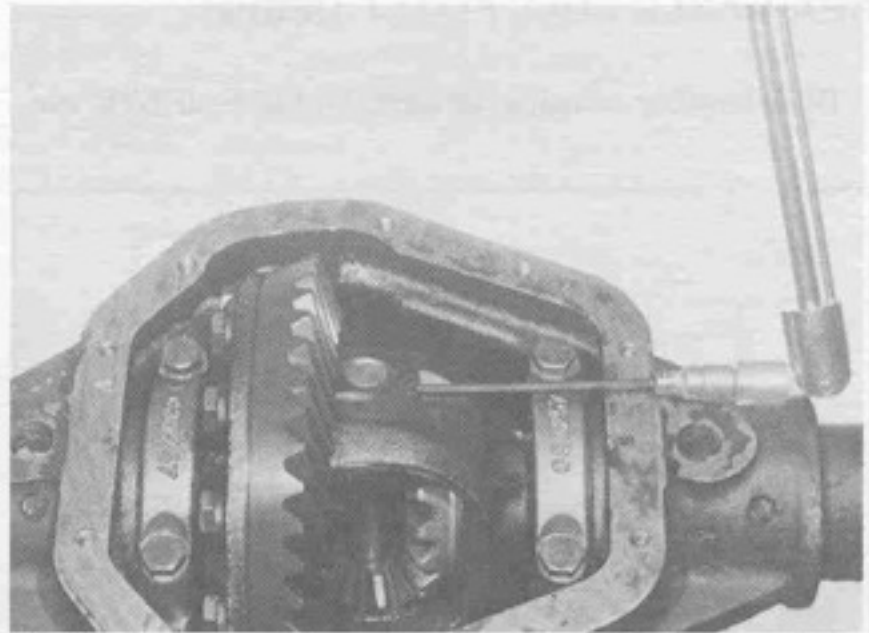

Figure 125

1019-125

Torque lock pin to 8 Lb. Ft. - minimum (11 N·m).
Tool: C-524-A Torque Wrench.

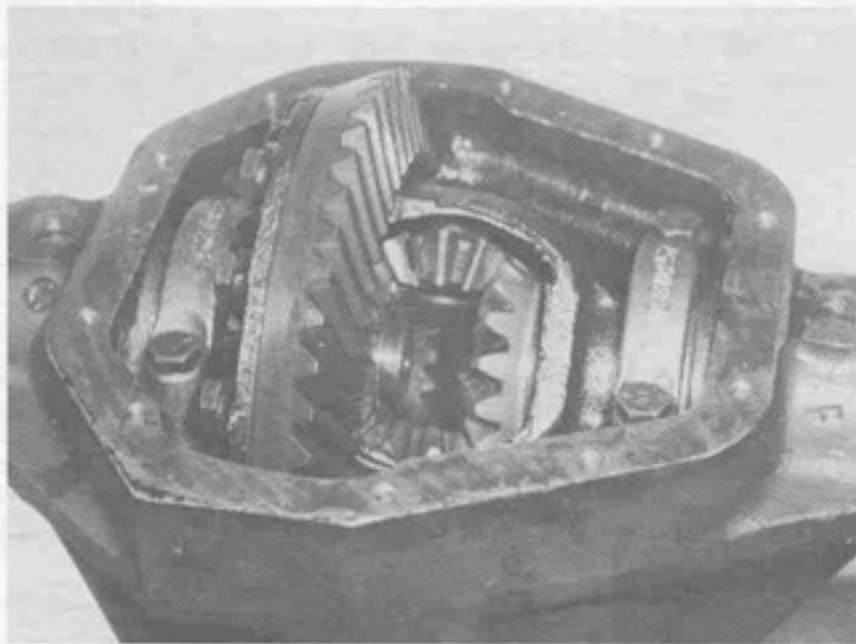

Figure 123

1019-123

Push flange end of axle shaft towards center of vehicle and install the "C" lock. Pull flange out from center of vehicle until "C" lock seats into differential side gears.



Figure 124

1019-124

Assemble pinion mate shaft. Be sure lock pin hole of the shaft is lined up with the lock pin hole of the case. Assemble lock pin.

NOTE
Whenever the lock pin is removed, it is to be replaced with a new one. New lock pins have a locking type material on the threads that secures the pin when in place. Before installing lock pin, make sure hole is free of dirt and oil.

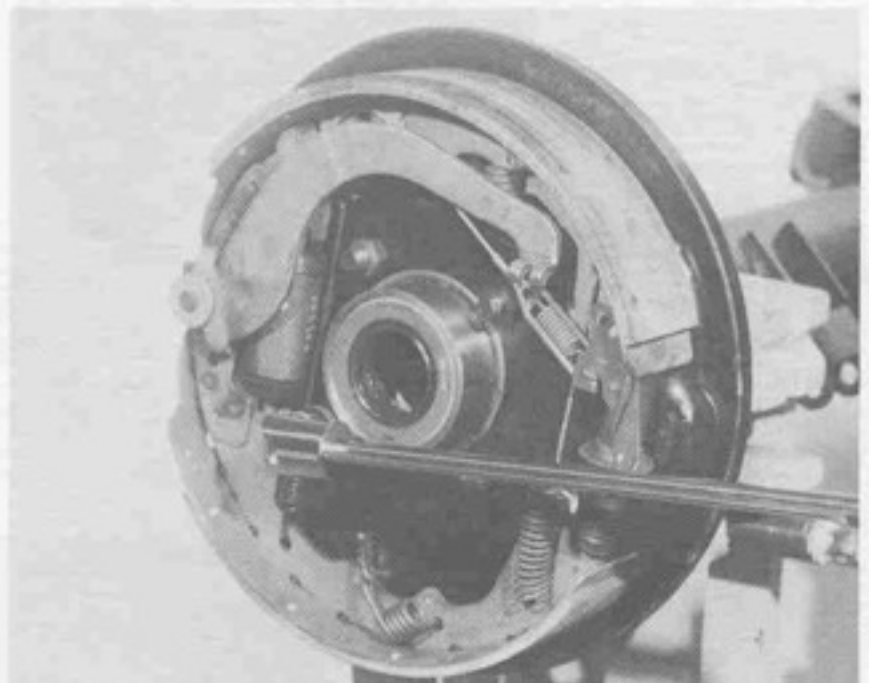

Figure 126

1019-126

Assemble backing plate assembly, using a torque wrench as shown, torque nuts to 50-85 Lbs. Ft. (68-115 N·m). Assemble brake drums, retainer nuts, wheels, etc.

Tool: #C-524-A Torque Wrench.

NOTE
Refer to carrier section for assembly of cover.

REAR AXLE

REAR AXLE FULL FLOAT DESIGN

Disassembly of hubs, drums, wheel bearings, etc.

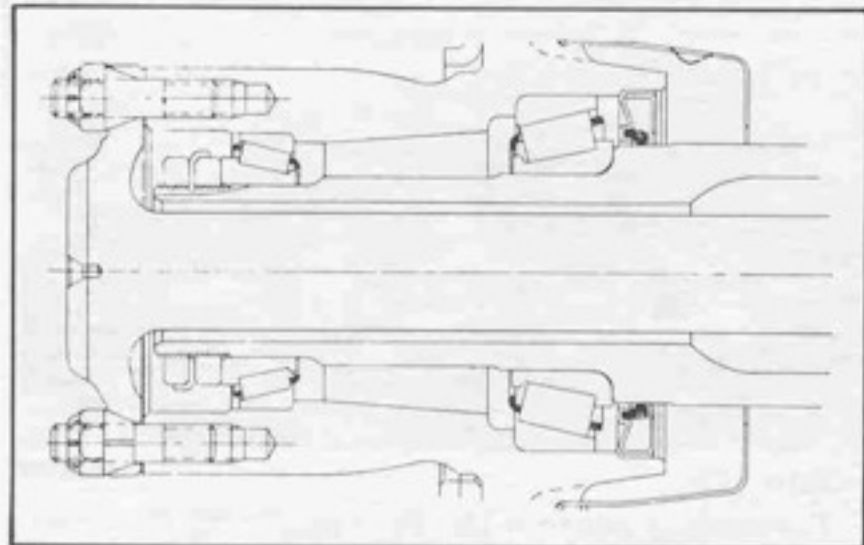

1019-127

Figure 127 L/D

Remove wheel from drum assembly.

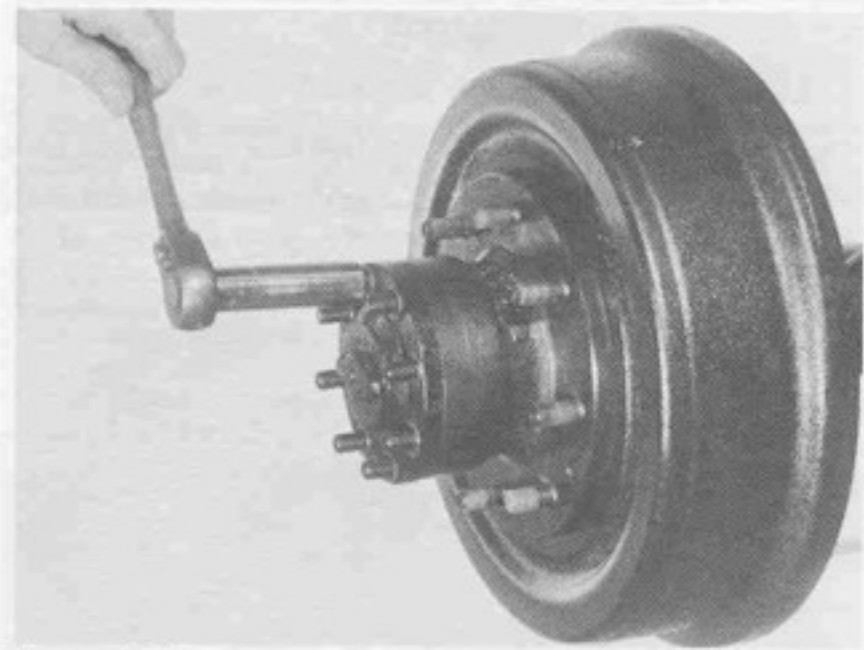

1019-128

Figure 128

Remove axle shaft nuts and/or cap screws, pull out axle shafts. If gasket is present between axle shaft flange and hub, discard gasket and replace with a new one at time of assembly.

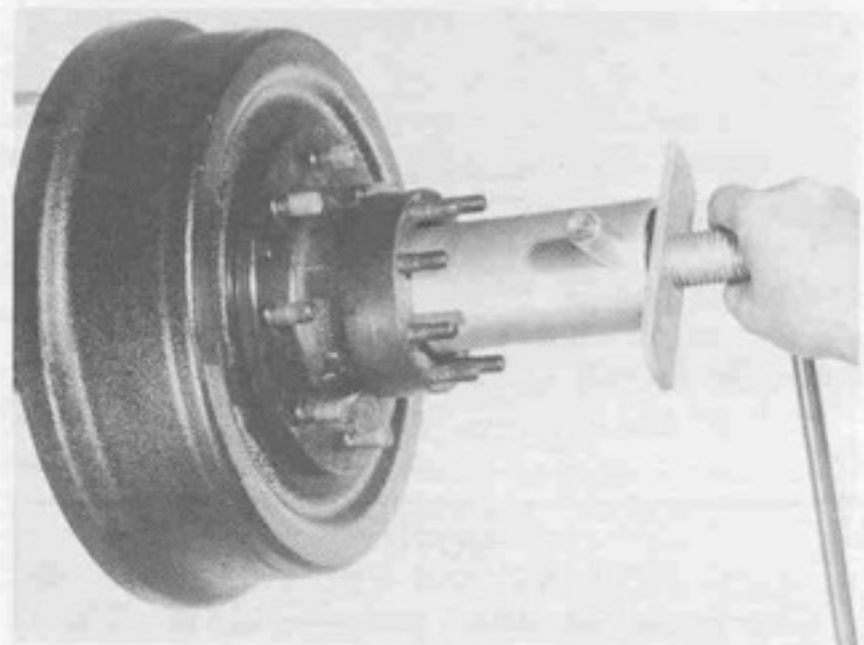

1019-129

Figure 129

If wheel bearing lockwasher is of the design in which the ears are bent over the flats of the wheel bearing nuts, bend ear up from the outerlock nut. Remove outer locknut, lockwasher and inner wheel bearing adjusting nut.

Tools: #DD-1241-J Wrench, #C-4202 Socket-Adapter.

NOTE
Due to various design wheel bearing nuts, wrenches of different sizes, which also use adapter C-4202 are available and are as follows:

WRENCH	OPENINGS	
DD-438	3-1/8" x 3-5/8"	Octagon
DD-824	2-9/16"	Octagon
DD-917-B	3-1/4"	Octagon
DD-926	3-1/2" x 4"	Hexagon
DD-1245	2-3/8"	Hexagon
DD-1280	2-3/4" x 7/8"	Octagon

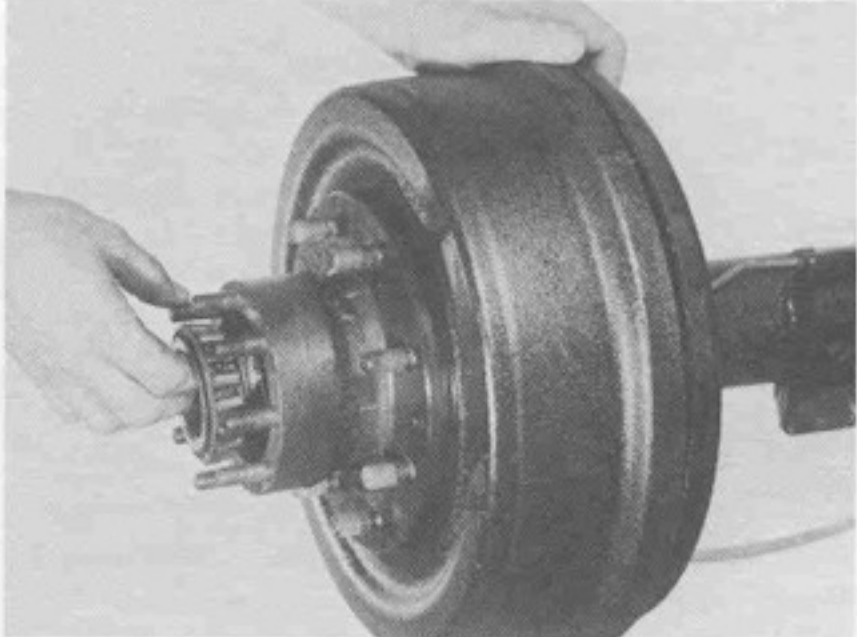

1019-130

Figure 130

Remove hub and drum assembly. The outer wheel bearing cone will slide out as the hub is removed.

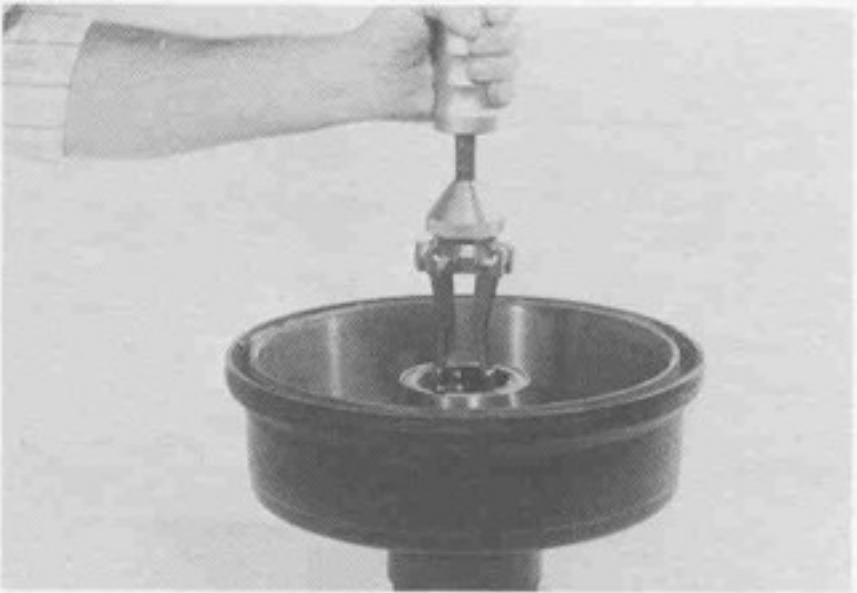

1019-131

Figure 131

Place hub on bench and remove grease seal. Discard seal and replace with new one at time of assembly.

Tool: #D-131 Slide Hammer.



Figure 132

1019-132

Remove inner and outer bearing cups from hub.

Tools: #D-162 Bearing Cup Remover, #C-4171 Handle.

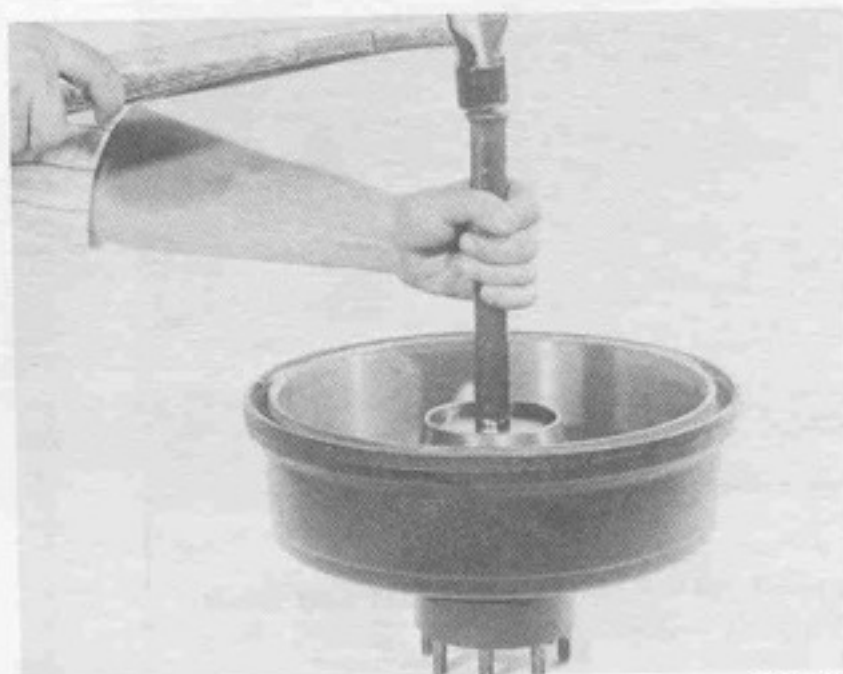

Figure 134

1019-134

Assemble new inner bearing cup.

Tools: #C-4308 Cup Installer, #C-4171 Handle.

Pack with grease and assemble new bearing cone.

ASSEMBLY

NOTE

It is recommended that whenever bearing cups and cones are removed they are to be replaced with new ones.

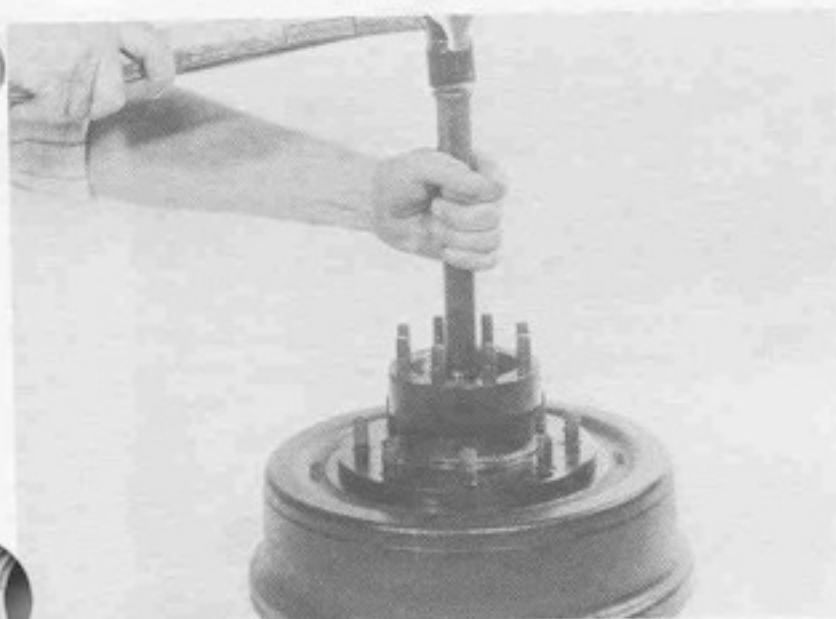

Figure 133

1019-133

Assemble new outer bearing cup.

Tools: #C-4308 Cup Installer, #C-4171 Handle.

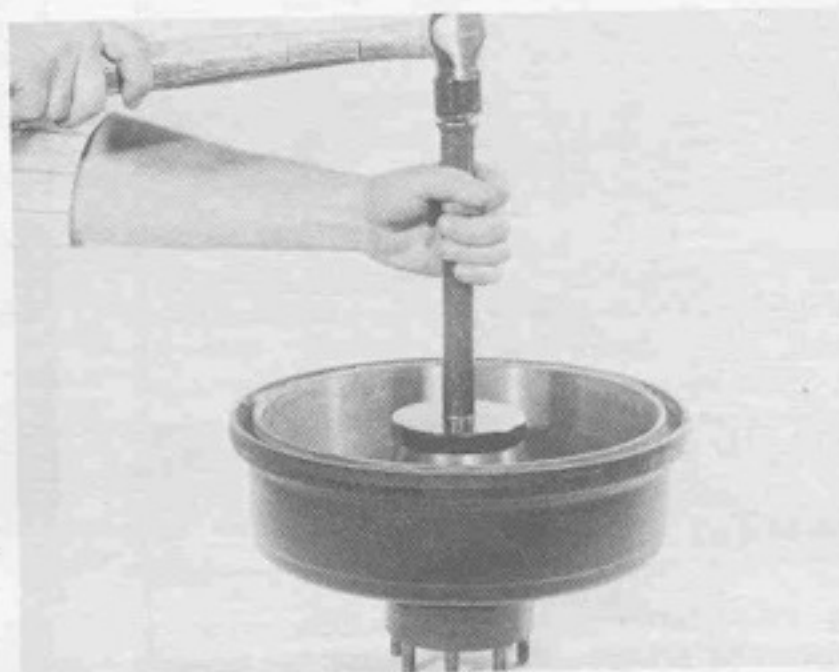

Figure 135

1019-135

Assemble new grease seal. Apply a small amount of the specified grease around lip of seal.

Tools: #D-155 Seal Installer, #C-4171 Handle.

Assemble hub assembly onto spindle. Pack with grease and assemble new outer bearing cone.

REAR AXLE

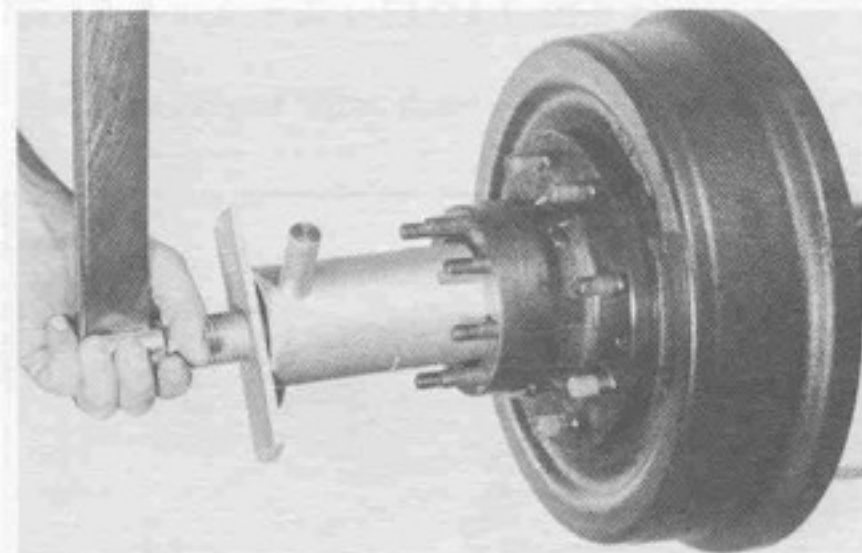

Figure 136 1019-136

Assemble inner wheel bearing adjusting nut, locktab and outer wheel bearing lock nut.

Tools: #DD-1241-J Wrench Socket, #C-4202 Adapter.

NOTE

For final wheel bearing adjustment and torque specifications, refer to Vehicle Service Manual.

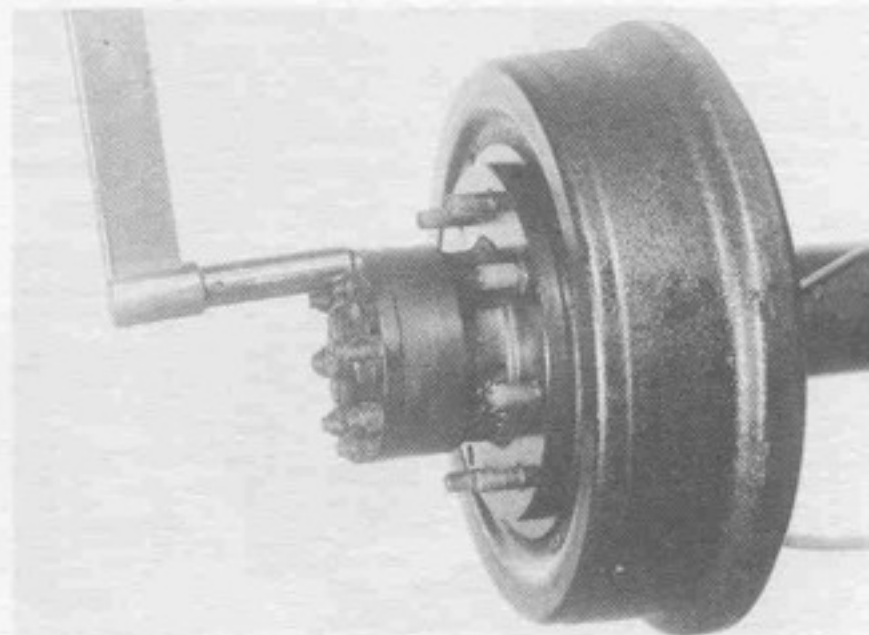

Figure 137 1019-137

Assemble new gasket, assemble axle shaft, torque nuts or cap screws. Refer to Vehicle Service Manual for proper torque specifications.

CARRIER SECTION

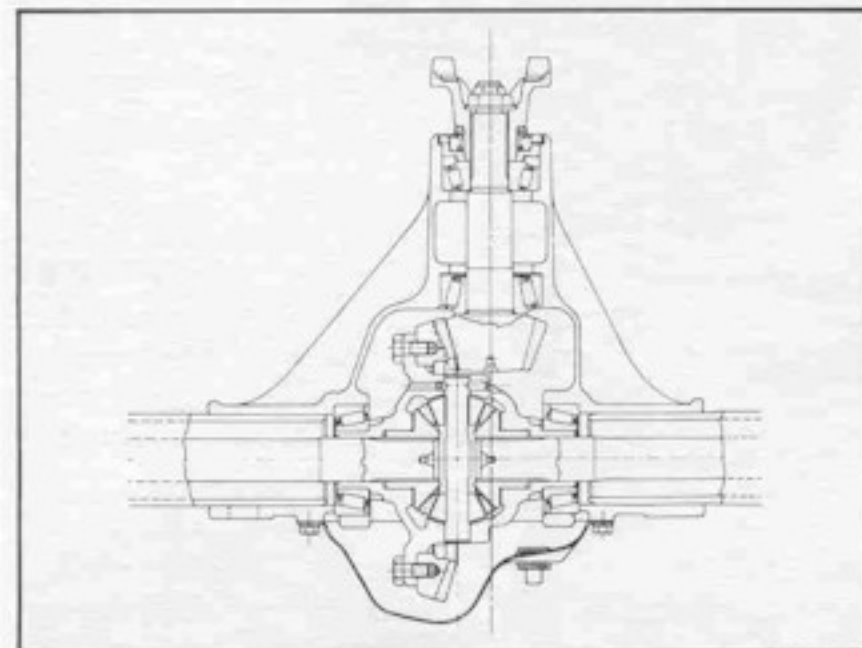

Figure 138 L/D Carrier Section 1019-138

DISASSEMBLY

NOTE

If it becomes necessary to disassemble any parts inside of the carrier, it is suggested that the entire axle be removed from the vehicle and held tight in a stand or rack.

Remove drain plug and drain lubricant. If there is no drain plug in the carrier, the lube will drain out as the cover plate is removed.

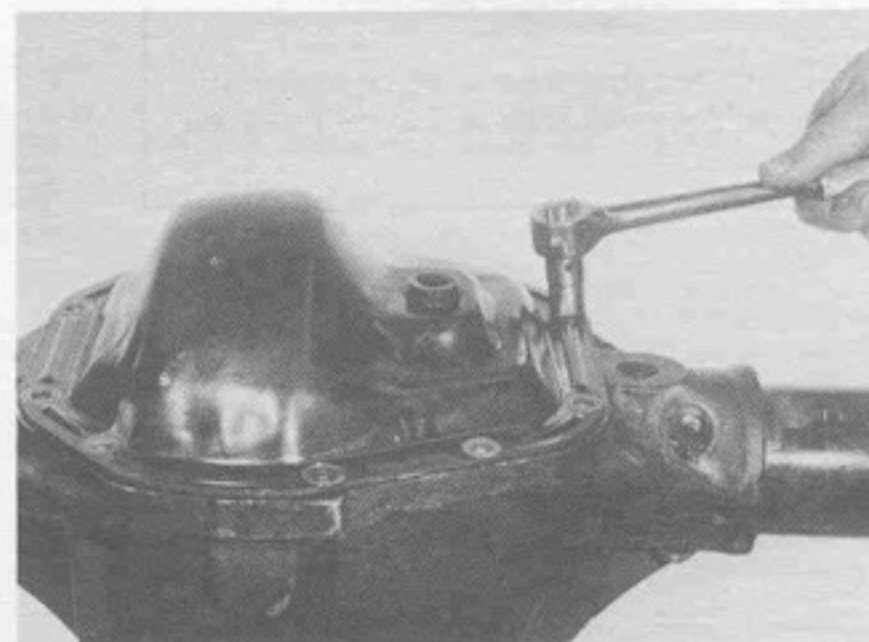

Figure 139 1019-139

Remove cover plate screws, cover plate, and cover plate gasket. Discard old gasket. Tip carrier to allow lube to drain completely. Also during this time clean the cover face of the carrier, making sure it is free from any nicks and any particles left by the old gasket. Do not use cleaning solvents of any type. Use of cleaning solvents may prevent the "RTV" sealer from adhering to the cover plate and carrier, resulting in leaks of axle lubricant.

CARRIER SECTION

CAUTION

Before removing differential case and ring gear, make sure the axle shafts are pulled out far enough for clearance to remove differential. Refer to section of manual covering the type of axle assembly being serviced for procedures on removing the axle shafts.

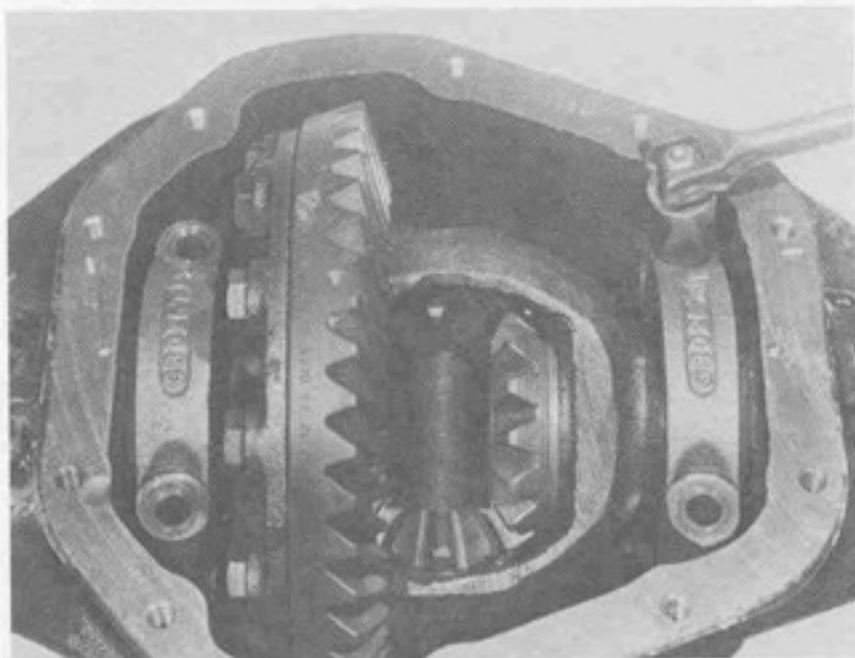

Figure 140

1019-140

Remove bearing caps. Note: Mating letters stamped on caps and carrier. This is important at time of assembly as they are to be assembled exactly as removed. Letters or numbers are in vertical and horizontal position.

NOTE

After removing axle shafts from the rear axle, semi-float shaft riding bearing unit, assemble pinion mate shaft and lock pin (finger tight only) into the differential case. This procedure is necessary to prevent the cross shaft from dropping out, and the differential side gears and differential pinion mate gears from rotating in the case and dropping out when servicing the carrier section.

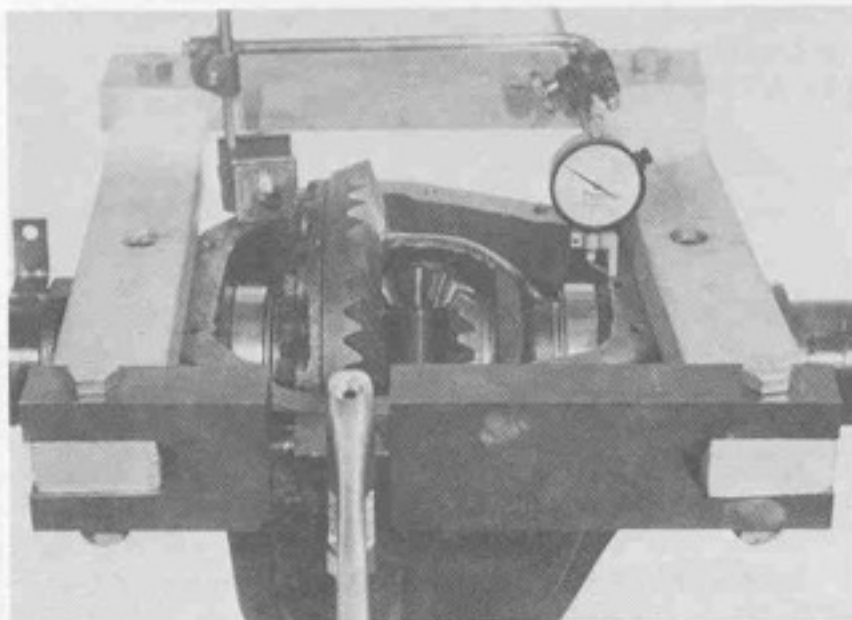

Figure 141

1019-141

Mount spreader to housing. Do not spread carrier over .015 (.38 mm). Use dial indicator as shown. Note: This spreader can also be used on the Spicer Model 44 axle.

Tools: #D-167 Spreader, #D-128 Indicator Set.

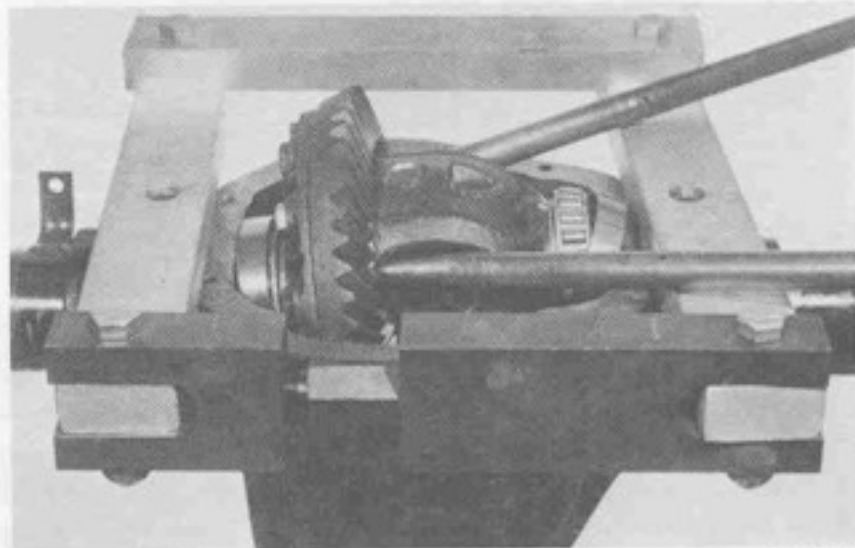

Figure 142

1019-142

Pry differential case from carrier with two pry bars as shown. After differential case has been removed, remove spreader. Use caution to avoid damage to ring and pinion. Mark or tag bearing cups indicating from which side they were removed.

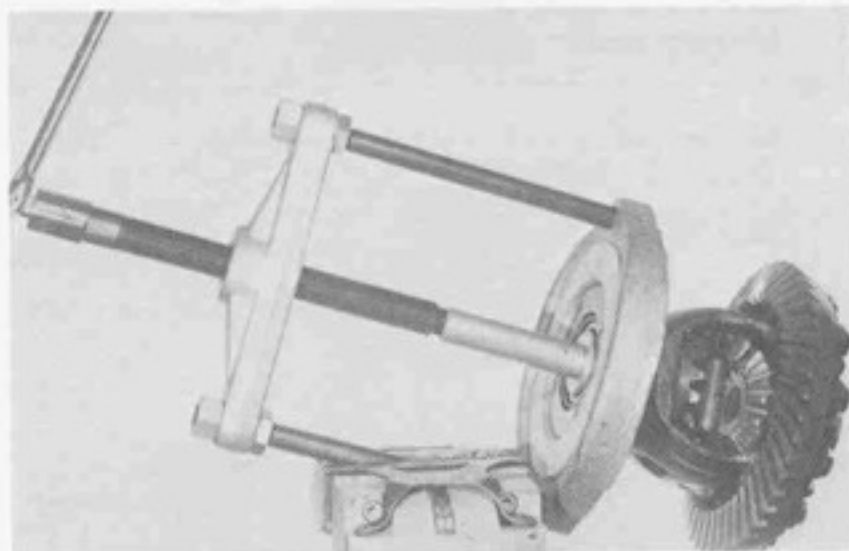

Figure 143

1019-143

Remove differential bearings with a puller as shown. Wire shims, bearing cup and bearing cone together. Identify from which side they were removed. (Ring gear side or opposite side). If shims are mutilated, replace with new ones at time of assembly. Shims are available in thicknesses of .003", .005", .010", and .030" (mm .08, .13, .25, and .76). Reposition case in puller and remove other bearing cone as described above.

Tools: #DD-914P Press, #DD-914-62 Adapter, #DD-914-8 Adapter Ring, #DD-914-7 Extension, #DD-914-42 Button.

NOTE

It is recommended that whenever bearings are removed, they are (regardless of milage) to be replaced with new ones.

CARRIER SECTION

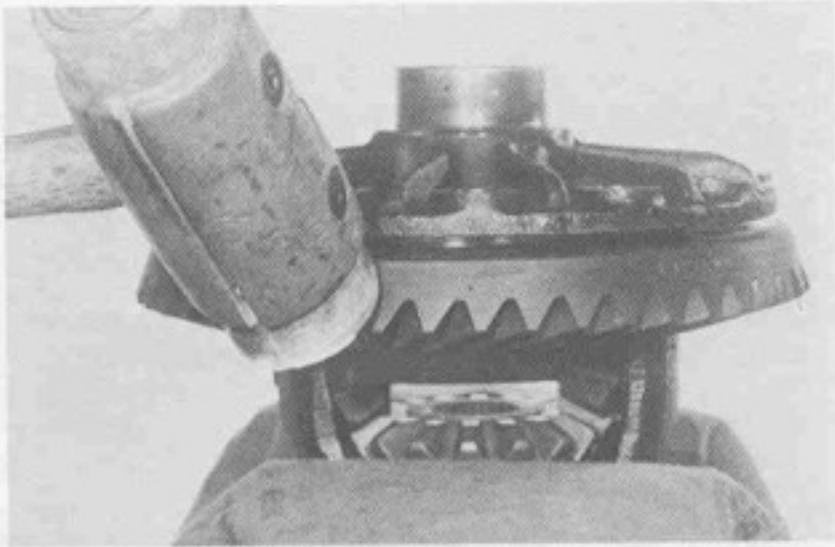

Figure 144

1019-144

Place a few shop towels over the vise to prevent the ring teeth from being nicked, after it is free from the case. Place case in vise. Remove ring gear screws. Tap ring gear with a rawhide hammer to free it from the case. Remove case and ring gear from vise.

NOTE

It is recommended that whenever the ring gear screws are removed they are to be replaced with new ones.



Figure 145

1019-145

Replace case in vise and drive out lock pin which secures the pinion mate shaft. Use a small drift as shown.

NOTE

The semi-float shaft riding bearing design has a lock pin that is removed with a wrench. The pinion mate shaft is of the slip fit design and can be removed by hand.



Figure 146

1019-146

Remove pinion mate shaft with drift as shown.

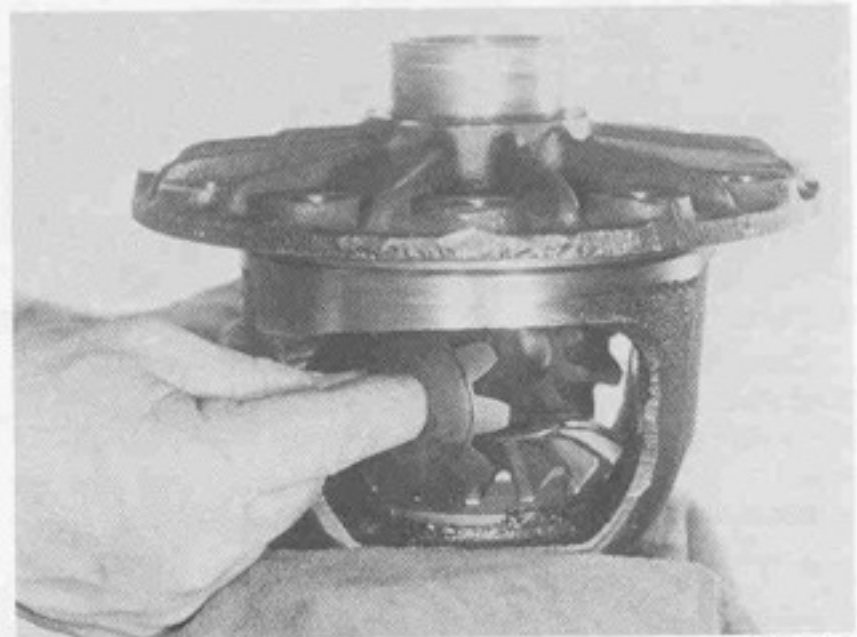

Figure 147

1019-147

To remove side gears and pinion mate gears, rotate the side gears. This will allow the pinion mate gears to turn to the opening of the case. Remove pinion mate gears and also the spherical washers behind the gears. Lift out side gears and thrust washers. Inspect all parts, including the machined surfaces of the case itself. If excessive wear is visible on all parts, it is suggested that the complete differential assembly be replaced. If any one of the gears are to be replaced, **THEY ARE TO BE REPLACED AS A SET.**

NOTE

Axle shafts which require end play adjustments have a spacer block in the differential case. The spacer block controls the end thrust of the axle shaft. If the ends of the spacer block are worn, it is to be replaced during assembly. Spacer block must not be used with ball or unitized wheel bearings.

CARRIER SECTION

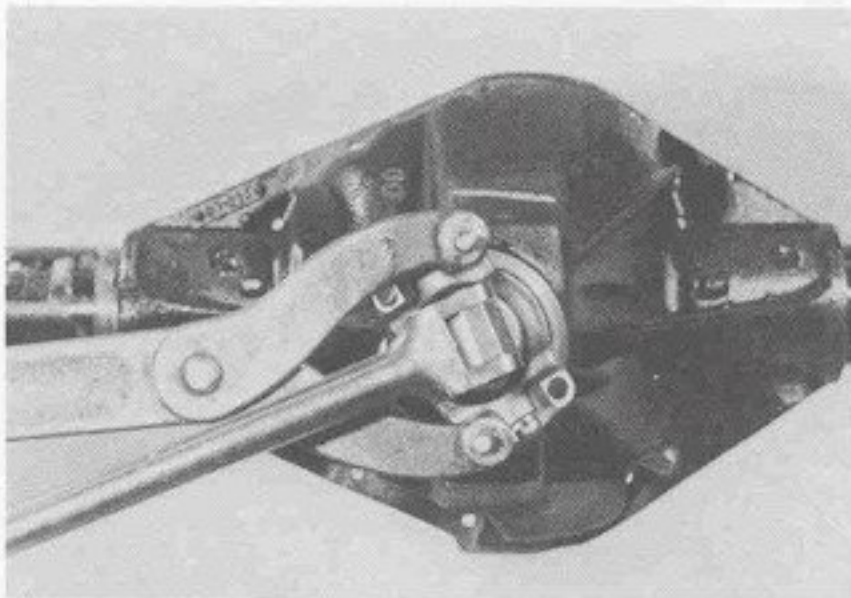

Figure 148 1019-148

Turn nose of carrier in a horizontal position, remove pinion nut. Hold end yoke or flange with tool, as shown, and remove pinion nut and washer.

Tool: #C-3281 Holding Wrench.

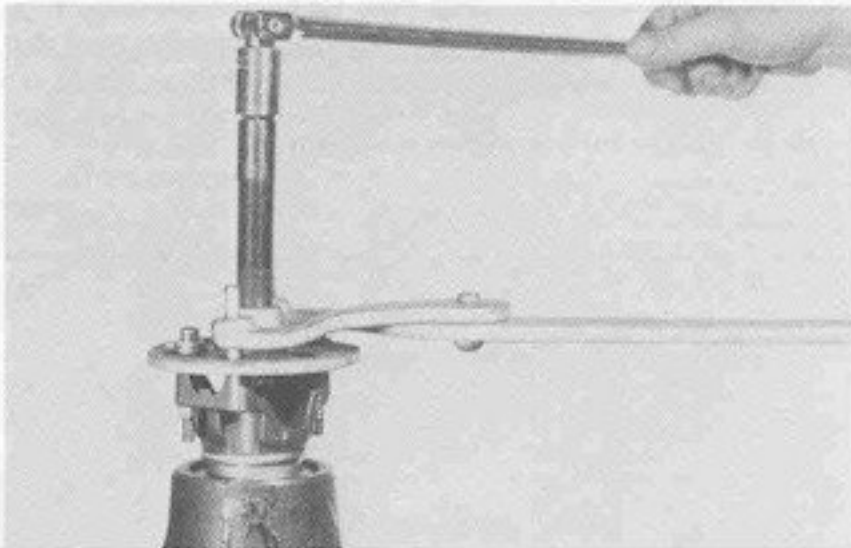

Figure 149 1019-149

Remove end yoke of flange with tools as shown. If end yoke or flange shows wear in the area of the seal contact, it should be replaced.

Tools: #C-3281 Holding Wrench, #C-452 Yoke Remover.



Figure 150 1019-150

Remove pinion by tapping with a rawhide hammer. Catch the pinion with your hand to prevent it from falling to the ground and being damaged.

NOTE

On the spline end of the pinion, there are bearing preload shims. These shims may stick to the pinion or bearing or even fall out. These shims are to be collected and kept together since they will be used later in assembly. Try not to mutilate shims. If shims are mutilated, replace with new ones. Shims are available in thicknesses of .003", .005", .010", and .030", (mm .08, .13, .25, and .76).

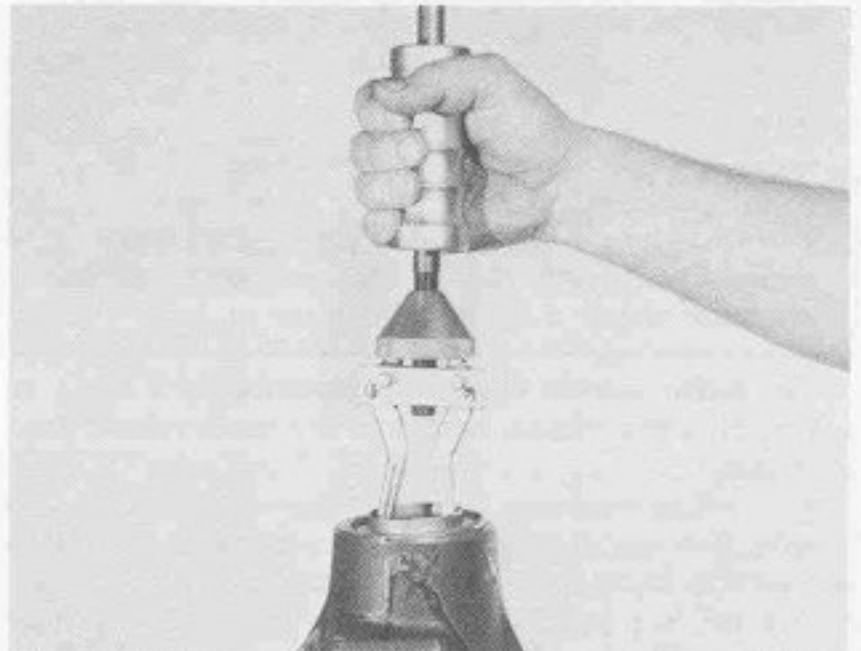

Figure 151 1019-151

Pull out pinion seal with puller as shown. Discard seal. REPLACE WITH NEW ONE AT TIME OF ASSEMBLY. Remove bearing cone and outer oil slinger.

Tool: #D-131 Slide Hammer.

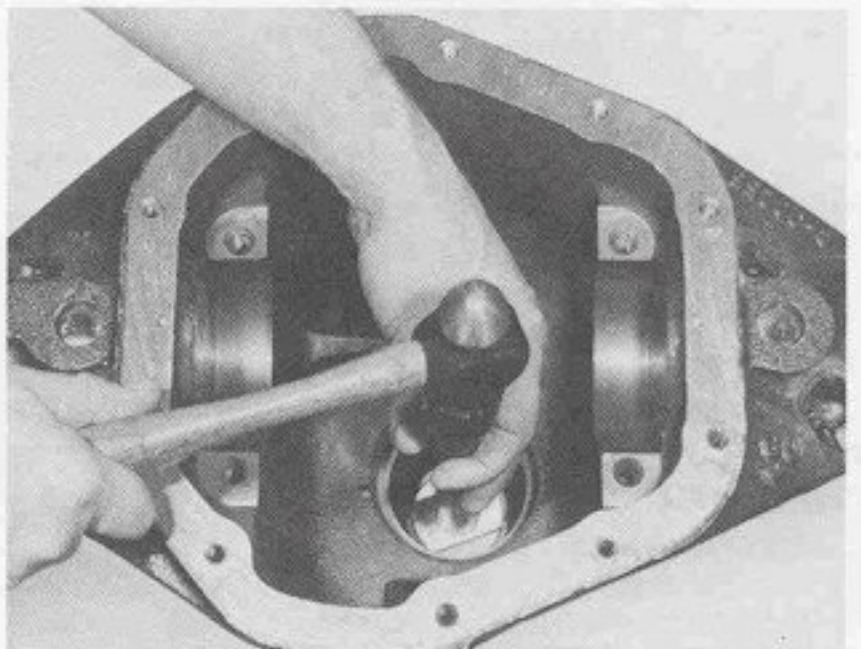

Figure 152 1019-152

Turn nose of carrier down. Remove outer pinion bearing cup. Locate driver on back edge of cup; drive cup out of carrier. **Caution: Do not nick carrier bore.**

Tools: #D-158 Cup Remover, #C-4171 Handle.

CARRIER SECTION

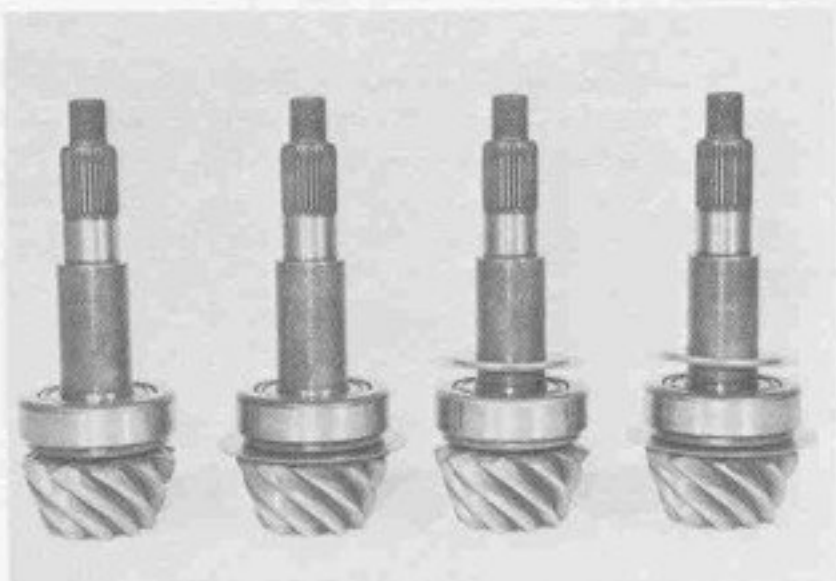

Figure 153

1019-153

NOTE

The front and rear carrier section may vary in pinion bore depth due to the possibility of the need for either a baffle or slinger or both.

The baffle serves the same purpose as a dam, to assure that the pinion bearings are maintained with lubricant.

The slinger serves the purpose of assisting the lube to flow up through the oil channels to lubricate the pinion bearings. If used, they are part of the pinion setting adjustment. In figure 153 we show the four different options.



Figure 154

1019-154

Remove the inner bearing cup with tools as shown.

Tools: #C-4171 Handle, #D-162 Cup Remover.

NOTE

Shims are located between the bearing cup and carrier bore and may also include an oil baffle. If shims and baffles are bent or nicked, they should be replaced at time of assembly. Wire and stack together and measure each. If stack has to be replaced, replace with same thickness.

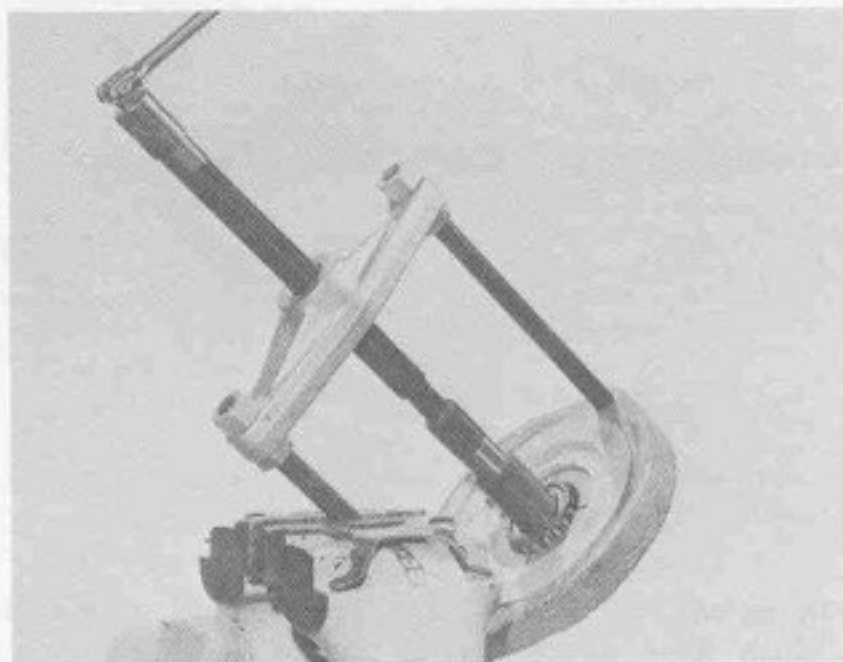

Figure 155

1019-155

Remove pinion bearing with tools as shown.

Tools: #DD-914-P Press, #DD-914-9 Adapter Ring, #C-293-37 Adapters.

NOTE

Both baffle and slinger are part of the pinion adjustment shims and are to be kept intact for assembly.

ASSEMBLY

On all front driving axles there are axle shaft oil seals pressed into the tube ends of the carrier.

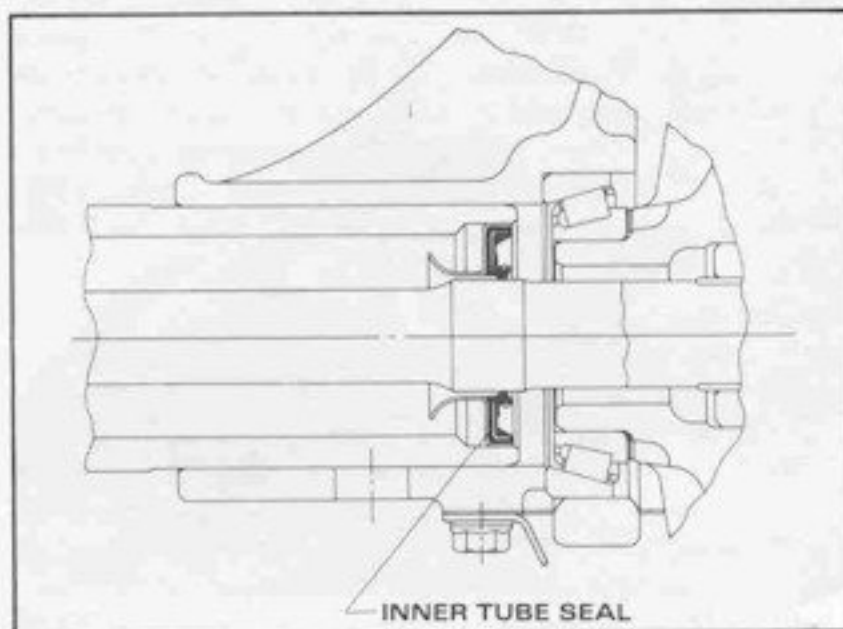

Figure L/D Carrier Seal 156

1019-156

As shown in figure 156, this design consists of the integral seal (unit) whereby the seal and guide are combined. (One seal for each side).

CARRIER SECTION

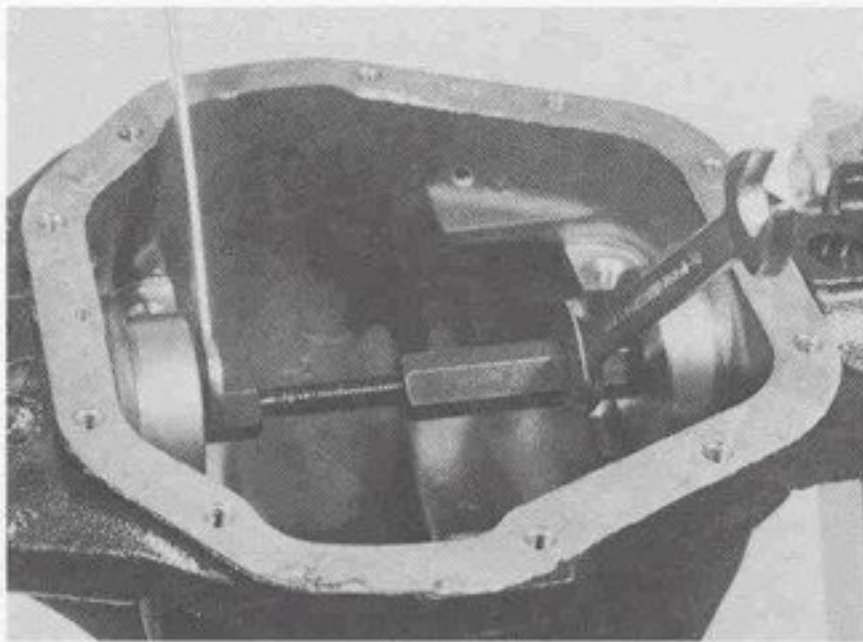

Figure 157 1019-157

Assemble inner axle shaft seals and guides. To assemble seals use tools as shown.

Tool: #D-195 Installer.

When assembling the seals, make sure they are positioned straight and do not get cocked. Turn forcing screw until it stops; seals will then be positioned. Grease lips of seals.



Figure 158 1019-158

Place differential case in vise as shown. Apply grease to new side gear thrust washers and to hubs and thrust face of the new side gears. Assemble both side gears. Apply grease to the new spherical washers, and the new pinion mate gears. Assemble new pinion mate gears and washers.

An easy way to assemble the side gears and pinion mate gears is to have all parts lubricated before assembly.

Assemble both side gears and thrust washers, hold them in place with hand, then assemble the pinion mate gears and washers to hold the side gears in place.

Rotate the side gears until the holes of the washers and pinion gears line up with the holes of the case. If the gears cannot be rotated by hand, install one of the axle shafts into the side gear spline and use a pipe wrench to turn the shaft.

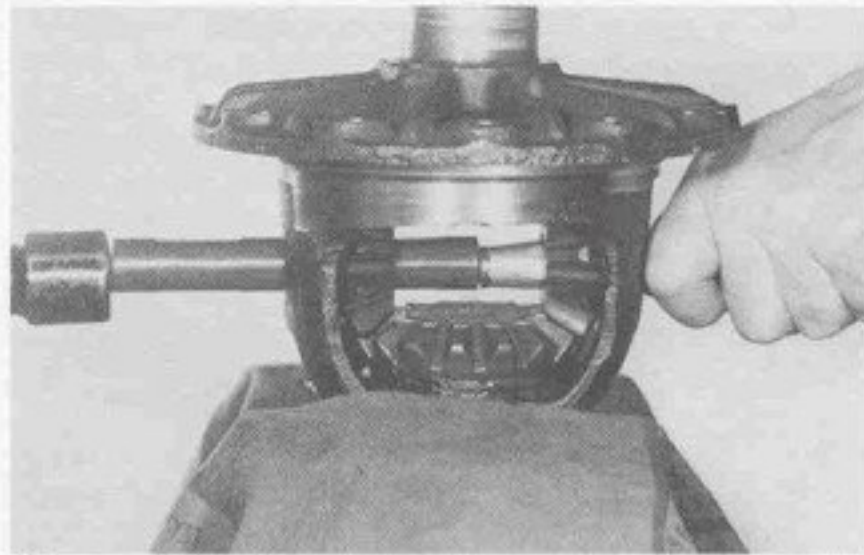

Figure 159 1019-159

Use a drift to line up the holes with those of the differential case.

Assemble pinion mate shaft, drive on shaft to remove drift. Be sure lock pin hole of the shaft is lined up with the lock pin hole of the case.



Figure 160 1019-160

Assemble lock pin. Peen metal of case over pin to lock in place.

NOTE

The semi-float shaft riding bearing design uses a lock pin that is assembled with the use of a wrench. Use lock pin and assemble finger tight only. This procedure is necessary to prevent differential side gears and differential pinion mate gears from rotating in the case and dropping out when servicing the carrier section. A new lock pin will be installed after assembling the axle shafts.

CARRIER SECTION

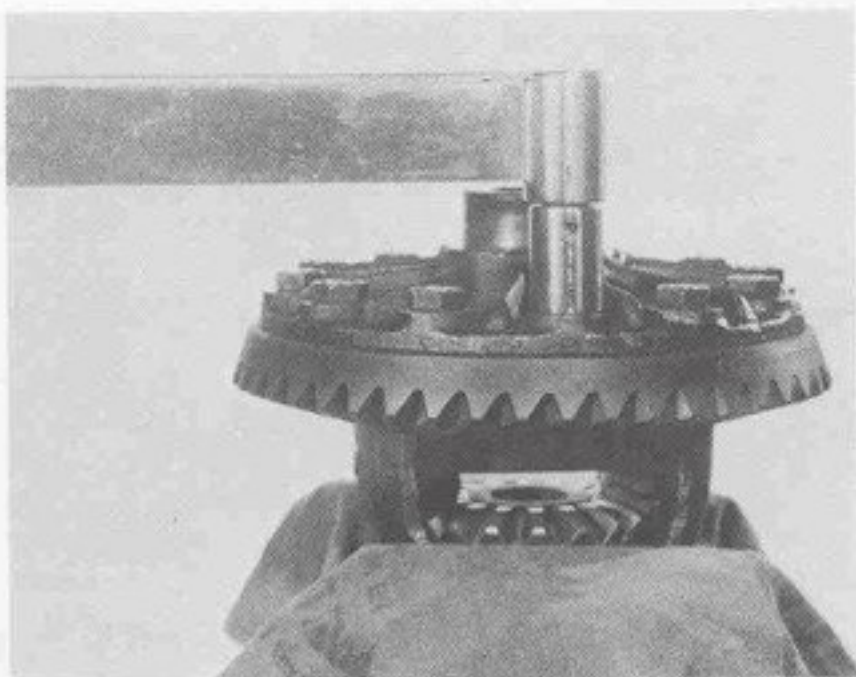

Figure 161

1019-161

Be sure flange face of the case is free of nicks or burrs. Assemble ring gear to case. Line up holes of the ring gear with those of the case. Use new ring gear screws. Draw up screws alternately and evenly. Torque ring gear screws to 100-120 Lb. Ft. (136-163 N·m).

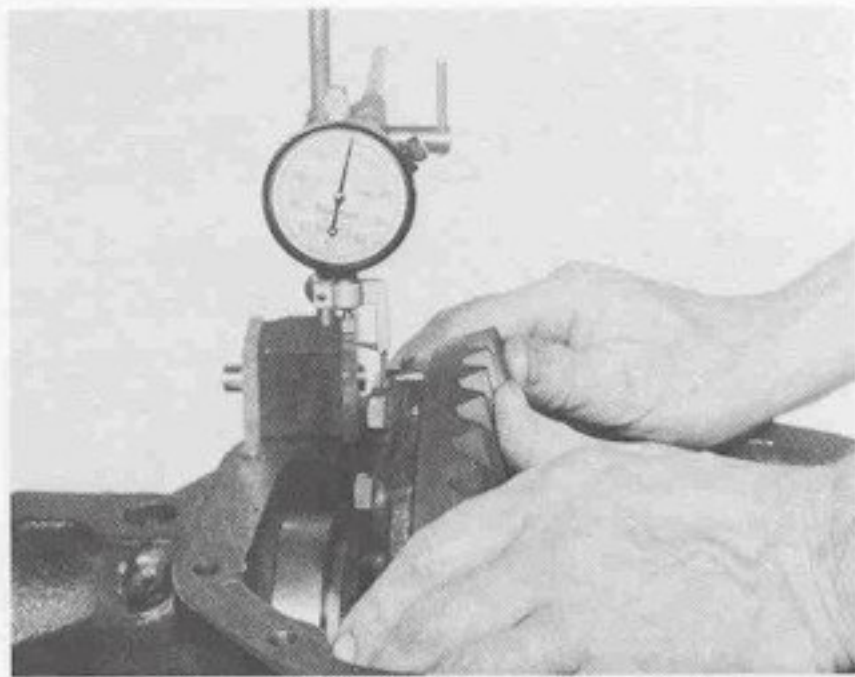

Figure 163

1019-163

Assemble differential case into carrier (less pinion). Mount dial indicator with a magnetic base as shown. Locate tip of indicator on flat surface of one of the ring gear screw spot faces. Mark location with a piece of chalk. Force differential assembly as far as possible in the direction towards the indicator. With force still applied, set indicator at zero (0).

Tool: #D-128 Indicator Set.

NOTE

Dial indicator should have a minimum travel of .200" (5.08 mm).

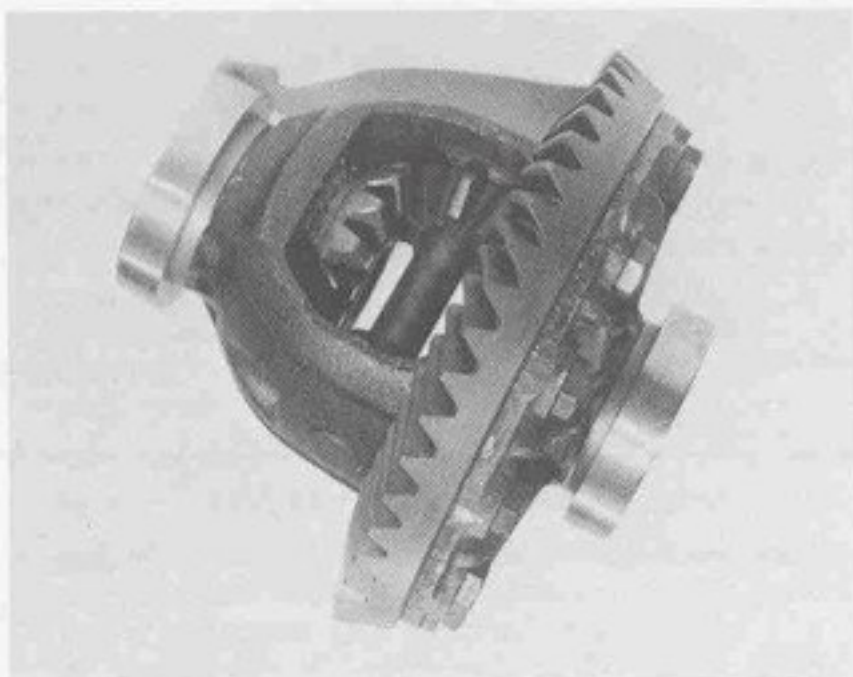

Figure 162

1019-162

Install master differential bearings onto case. Remove all nicks, burrs, dirt, etc., from hubs to allow master bearings to rotate freely.

Tool: #D-117 Master Differential Bearings.

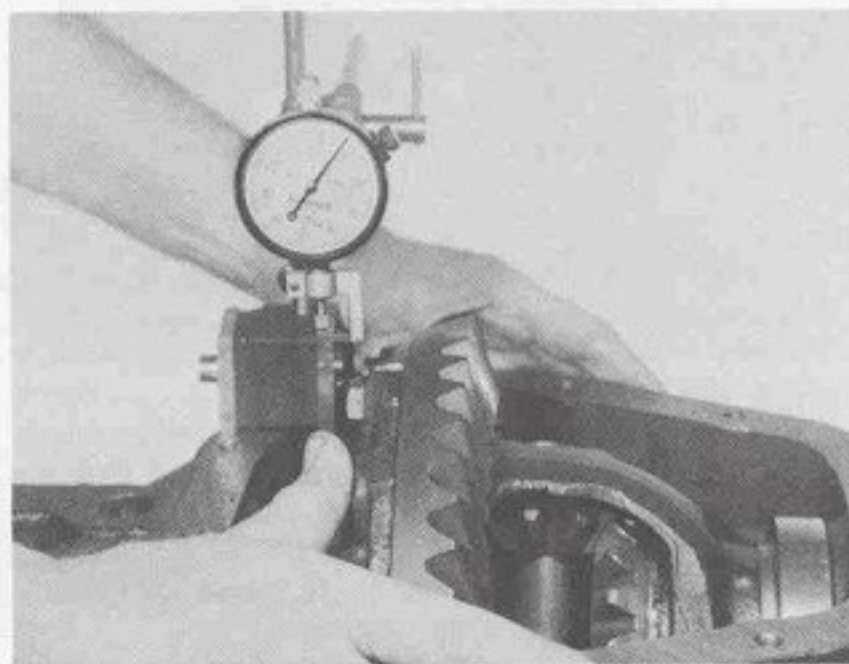

Figure 164

1019-164

Force the differential assembly as far as it will go in the opposite direction. Repeat these steps until you have obtained the same reading. Record the reading of the indicator. This will be the total amount of shims required (less preload) and will be calculated later during assembly. After making sure the readings are correct, remove indicator and differential assembly from housing. **DO NOT REMOVE MASTER BEARINGS FROM DIFFERENTIAL CASE AT THIS TIME.**

CARRIER SECTION

VIEW OF RING AND PINION SET

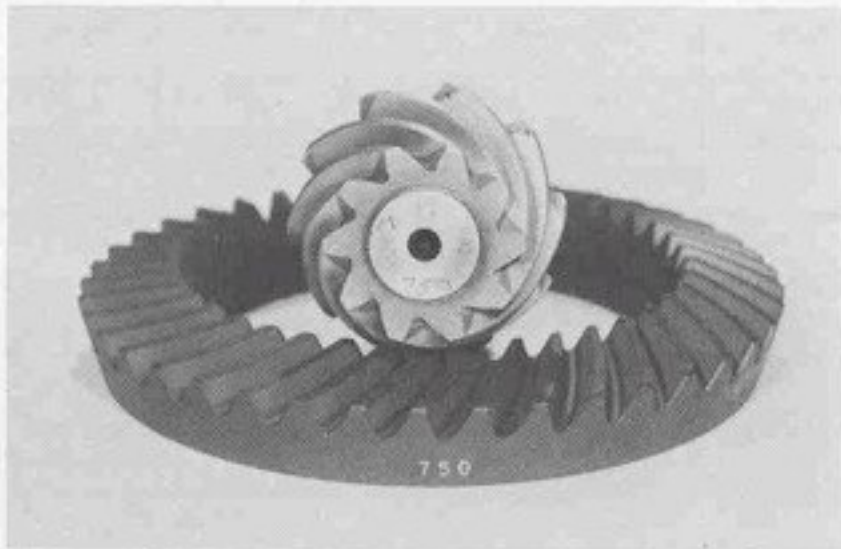

Figure 165

1019-165

Ring gears and pinions are supplied in matched sets only. Matching numbers on both the pinion and ring gear are etched for verification. If a new gear set is being used, verify the numbers of each pinion and ring gear before proceeding with assembly.

The nominal distance from the centerline of the ring gear to the end of the pinion for the model 60 (front and rear) axle is 3.125" (79.37 mm).

On the button end of each pinion, there is etched a plus (+) number, a minus (-) number, or a zero (0) number which indicates the best running position for each particular gear set. This dimension is controlled by the shimming behind the inner pinion bearing cup.

For example - If a pinion is etched a plus +3 (m+8), this pinion would require .003" (.08 mm) less shims than a pinion etched "0". This means by

removing shims, the mounting distance of the pinion is increased to 3.128" (79.45 mm), which is just what a +3 (m+8) indicates. Or if a pinion is etched -3 (m-8), we would want to add .003" (.08 mm) more shims than would be required if the pinion were etched "0". By adding .003" (.08 mm) shims, the mounting distance of the pinion was decreased to 3.122" (79.30 mm) which is just what a -3 (m-8) indicated.

If the old ring and pinion set is to be reused, measure the old shim pack and build a new shim pack to this same dimension. If a baffle is used in the axle assembly, it is considered as part of the shim pack.

To change the pinion adjustments, shims are available in thicknesses of .003", .005", and .010" (mm .08, .13, and .25).

NOTE

If baffle or slinger is bent or mutilated, it should be replaced.

Measure each shim separately with a micrometer and add together to get total shim pack thickness from the original build up.

If a new gear set is being used, notice the (+) or (-) etching on both the old and new pinion and adjust the thickness of the new shim pack to compensate for the difference of these two figures.

For example - If the old pinion reads (+) 2 (m+5) and the new pinion is (-) 2 (m-5), add .004" (.10 mm) shims to the original shim pack.

The above procedures also apply to pinion adjustment on the front axle which includes the oil slinger between the inner bearing cone and pinion, and baffle between the inner bearing cup and carrier.

Old Pinion Marking	New Pinion Marking								
	-4	-3	-2	-1	0	+1	+2	+3	+4
+4	+0.008	+0.007	+0.006	+0.005	+0.004	+0.003	+0.002	+0.001	0
+3	+0.007	+0.006	+0.005	+0.004	+0.003	+0.002	+0.001	0	-0.001
+2	+0.006	+0.005	+0.004	+0.003	+0.002	+0.001	0	-0.001	-0.002
+1	+0.005	+0.004	+0.003	+0.002	+0.001	0	-0.001	-0.002	-0.003
0	+0.004	+0.003	+0.002	+0.001	0	-0.001	-0.002	-0.003	-0.004
-1	+0.003	+0.002	+0.001	0	-0.001	-0.002	-0.003	-0.004	-0.005
-2	+0.002	+0.001	0	-0.001	-0.002	-0.003	-0.004	-0.005	-0.006
-3	+0.001	0	-0.001	-0.002	-0.003	-0.004	-0.005	-0.006	-0.007
-4	0	-0.001	-0.002	-0.003	-0.004	-0.005	-0.006	-0.007	-0.008

Figure 166

1019-166

Pinion Setting Chart (English U.S. Standard).

CARRIER SECTION

Old Pinion Marking	New Pinion Marking								
	-10	-8	-5	-3	0	+3	+5	+8	+10
+10	+0.20	+0.18	+0.15	+0.13	+0.10	+0.08	+0.05	+0.03	0
+8	+0.18	+0.15	+0.13	+0.10	+0.08	+0.05	+0.03	0	-0.03
+5	+0.15	+0.13	+0.10	+0.08	+0.05	+0.03	0	-0.03	-0.05
+3	+0.13	+0.10	+0.08	+0.05	+0.03	0	-0.03	-0.05	-0.08
0	+0.10	+0.08	+0.05	+0.03	0	-0.03	-0.05	-0.08	-0.10
-3	+0.08	+0.05	+0.03	0	-0.03	-0.05	-0.08	-0.10	-0.13
-5	+0.05	+0.03	0	-0.03	-0.05	-0.08	-0.10	-0.13	-0.15
-8	+0.03	0	-0.03	-0.05	-0.08	-0.10	-0.13	-0.15	-0.18
-10	0	-0.03	-0.05	-0.08	-0.10	-0.13	-0.15	-0.18	-0.20

Figure 167

Pinion Setting Chart Metric

1019-167

If metric used pinion will be etched Exp. (m+5). Use these charts as a guideline to set pinion.

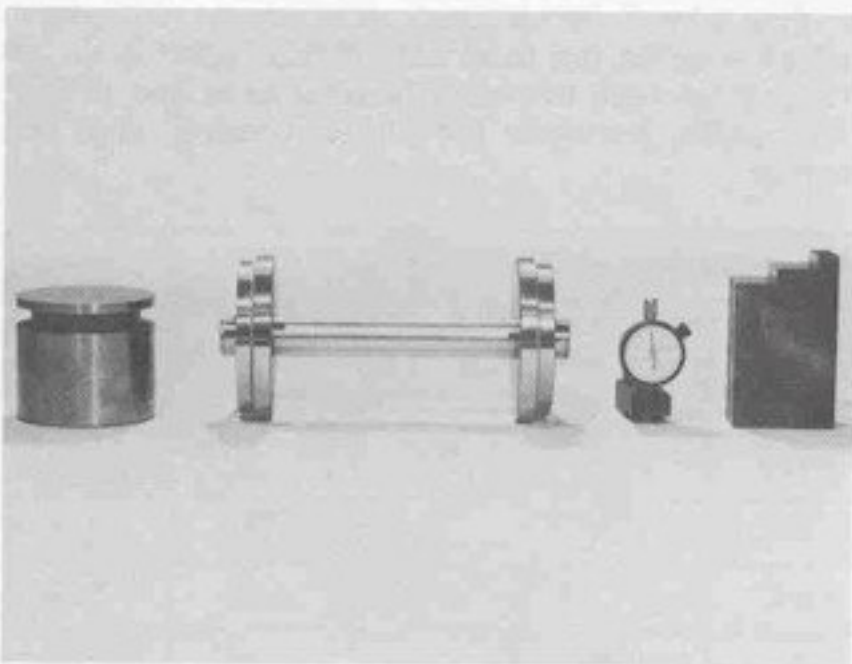

Figure 168

1019-168

View of master pinion block, pinion height block, scooter gage, cross pin, and master bearing discs.

NOTE

Cross arbor, master bearing discs, and scooter gage can be used on both Model 60 and Model 70 axles.

Make sure that all carrier bores are free from all nicks, dirt or any other contamination.

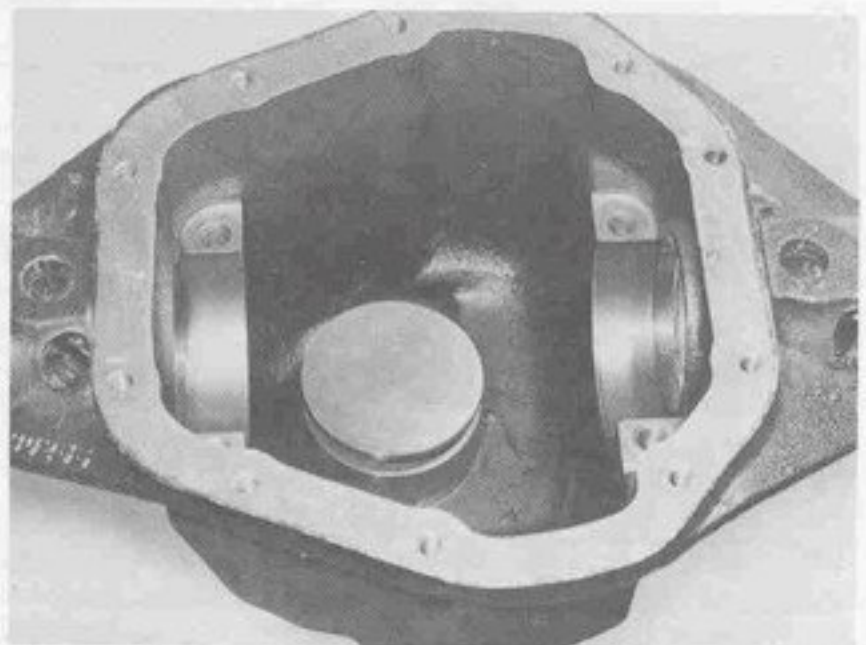

Figure 169

1019-169

Place master pinion block into the pinion bore of the carrier as shown.

Tool #D-120 Master Pinion Block.

CARRIER SECTION

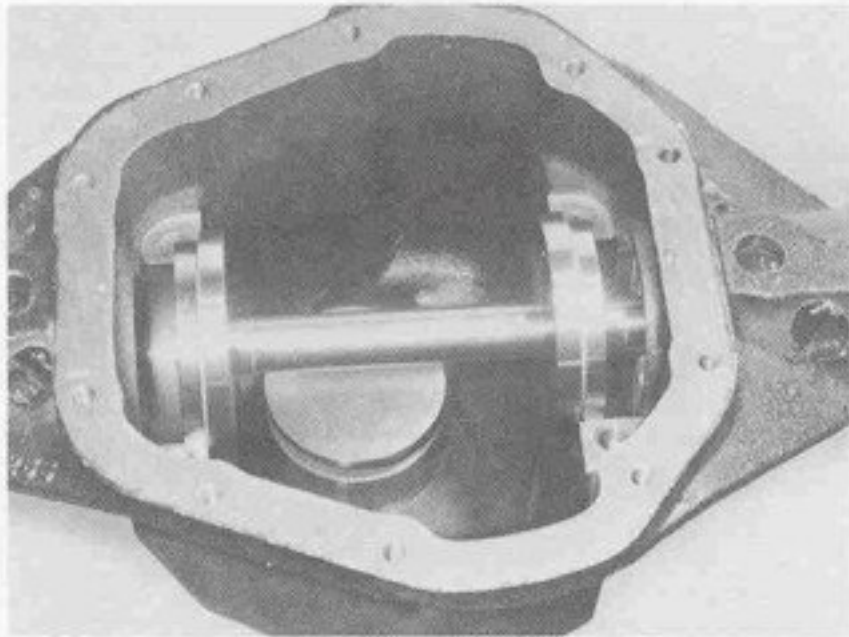

Figure 170 1019-170
Place arbor discs (small diameters) and arbor into cross bores of carrier as shown.
Tools: #D-116-2 Master Discs, #D-115-3 Arbor.

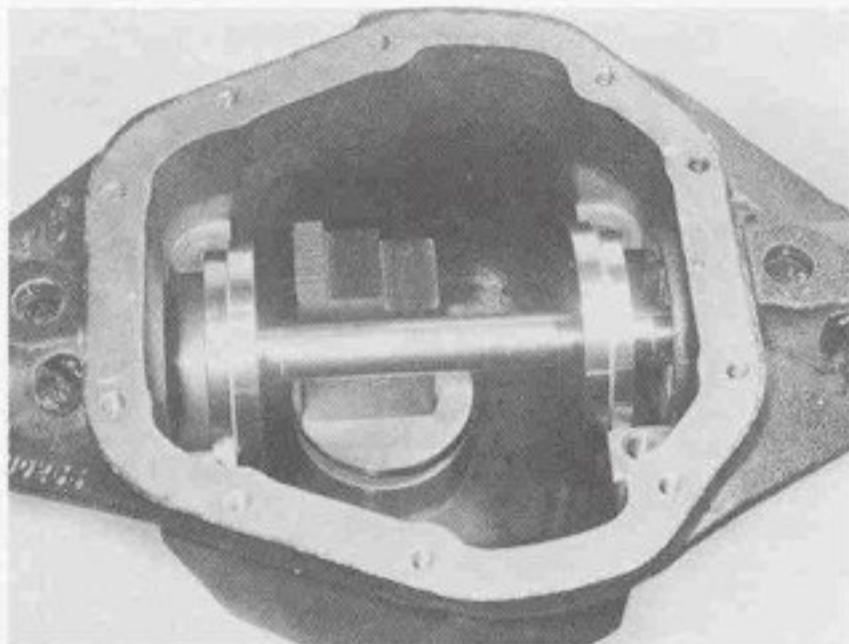

Figure 171 1019-171
Place pinion height block on top of master pinion block and against arbor as shown.
Tool: #D-116-1 Pinion Height Block.

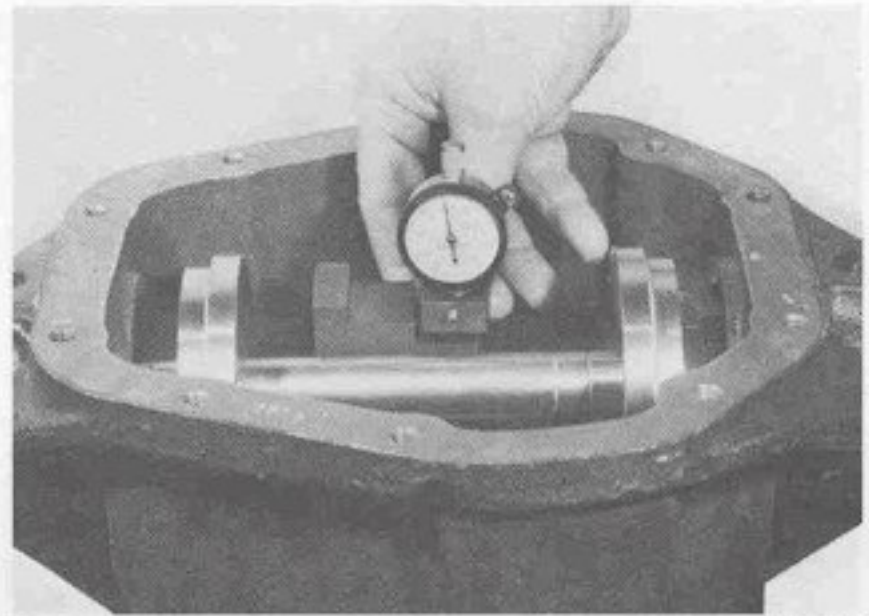

Figure 172 1019-172
Place scooter gage on small step of pinion height block. Apply pressure with fingers, making sure the gage is flat on the pinion block, while pressure is applied set indicator at zero "0".
Tool: #D-115 Scooter Gage.

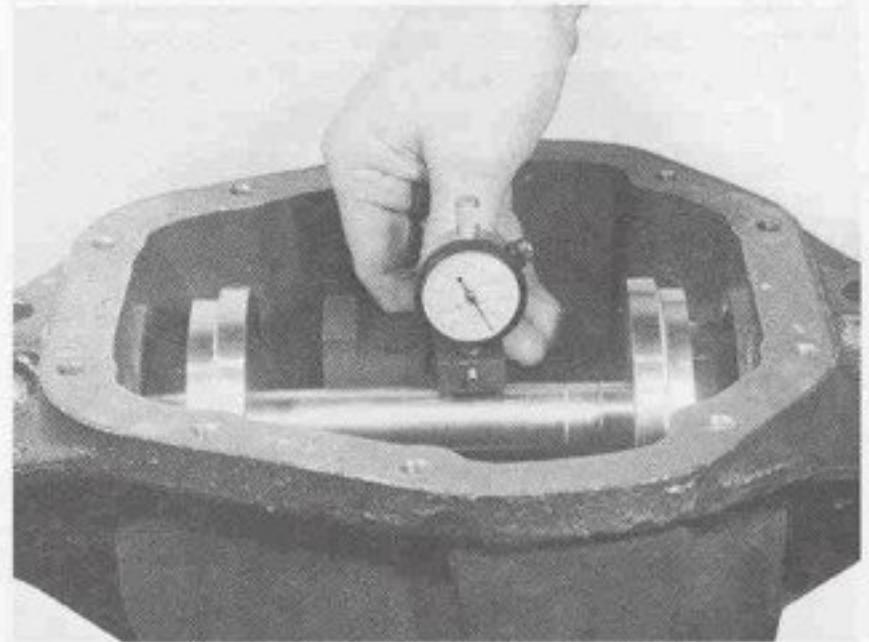

Figure 173 1019-173
Slide scooter gage over arbor. As gage slides over top of arbor, it will travel in a clockwise direction. When indicator is on center of arbor (on top) it will stop travelling in a clockwise direction. If indicator starts to travel in a counter-clockwise direction, this means you have passed the center (top) of the arbor. Record only the reading when the indicator is at the highest point.
This reading indicates the amount of shims necessary to obtain the shim pack, plus (+) or minus (-) the etching on the button end of the pinion.
If the etching is zero (0), the shim pack will remain unchanged.
For example: If the pinion is etched +3 (m+8), this pinion would require .003" (.08 mm) less shims than a pinion etched zero (0).
If the pinion is etched -3 (m-8), this would require .003" (.08 mm) more shims than a pinion etched zero (0).

CARRIER SECTION

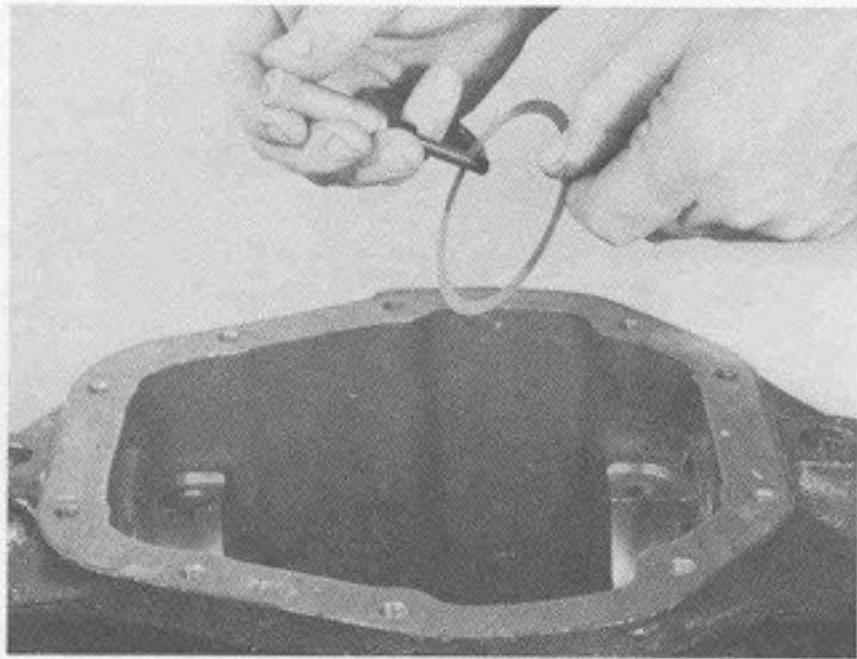

Figure 174 1019-174

Measure each shim separately with a micrometer and add together to get total shim pack thickness. If baffle is required it is to be included in the shim pack. If slinger is used between the inner bearing cone and thrust face of pinion, the slinger is also to be measured and included as part of the total shim pack.



Figure 176 1019-176

Assemble the outer pinion bearing cup into carrier as shown, make sure cup is seated.

Tools: #C-4203 Cup Installer, #C-4171 Handle.

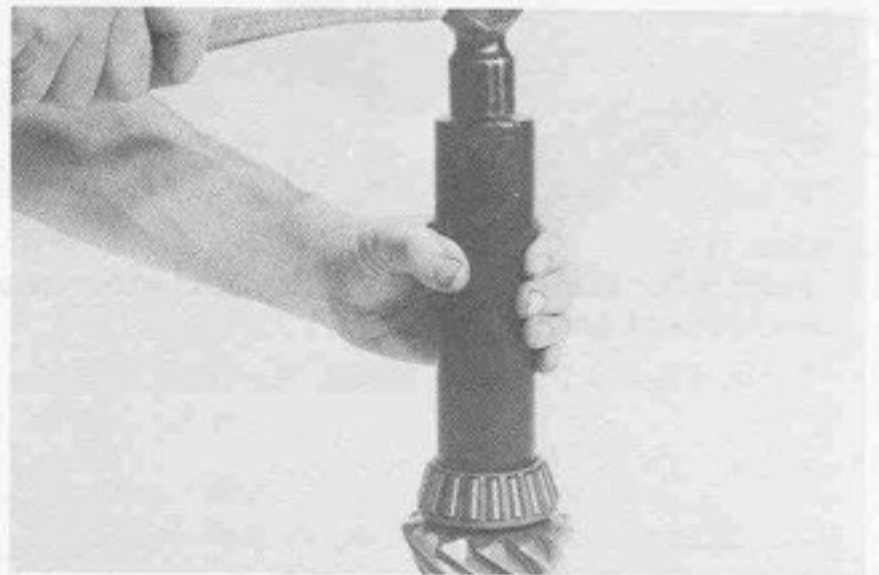

Figure 177 1019-177

Assemble inner bearing cone (and slinger if used) on pinion. Drive bearing on shaft until it is completely seated.

Tool: #C-3095-A Bearing Installer.

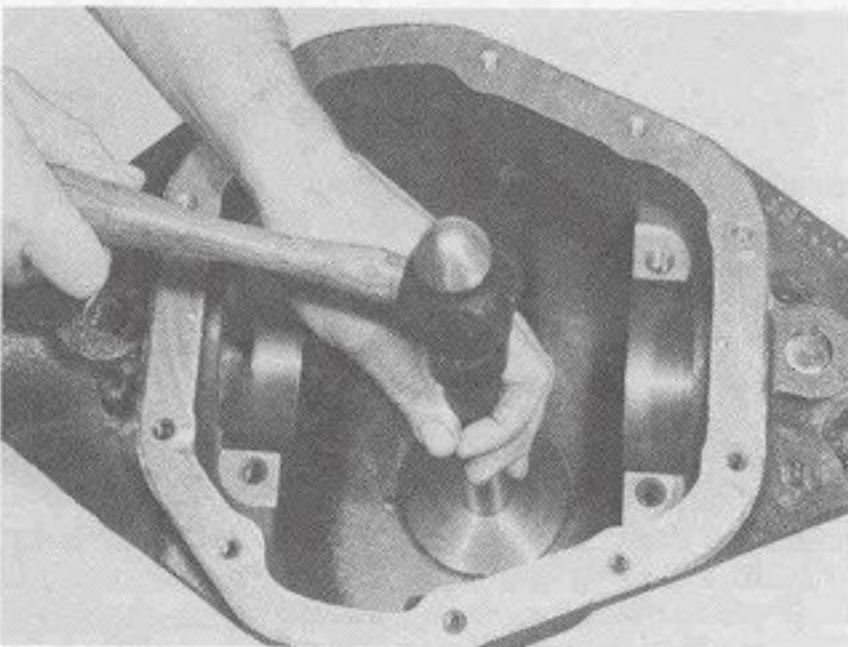

Figure 175 1019-175

Place the required amount of shims (and baffle if used) in the inner bearing bore; drive the inner bearing cup into the carrier. Make sure cup is seated.

Tools: #D-111 Cup Installer, #C-4171 Handle.

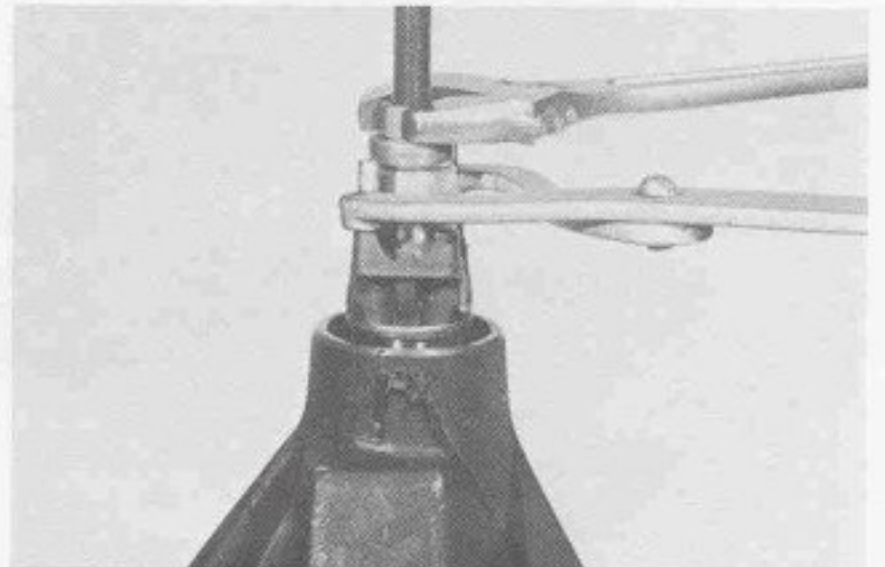

Figure 178 1019-178

Assemble pinion into carrier. Assemble outer pinion bearing cone, (and slinger if used) and end yoke onto pinion spline.

CARRIER SECTION

NOTE

Do not assemble preload shims or pinion oil seal at this time.

Use yoke installer as shown to assemble end yoke onto spline of pinion.

Tools: #C-3718 Installer, #C-3281 Holder.

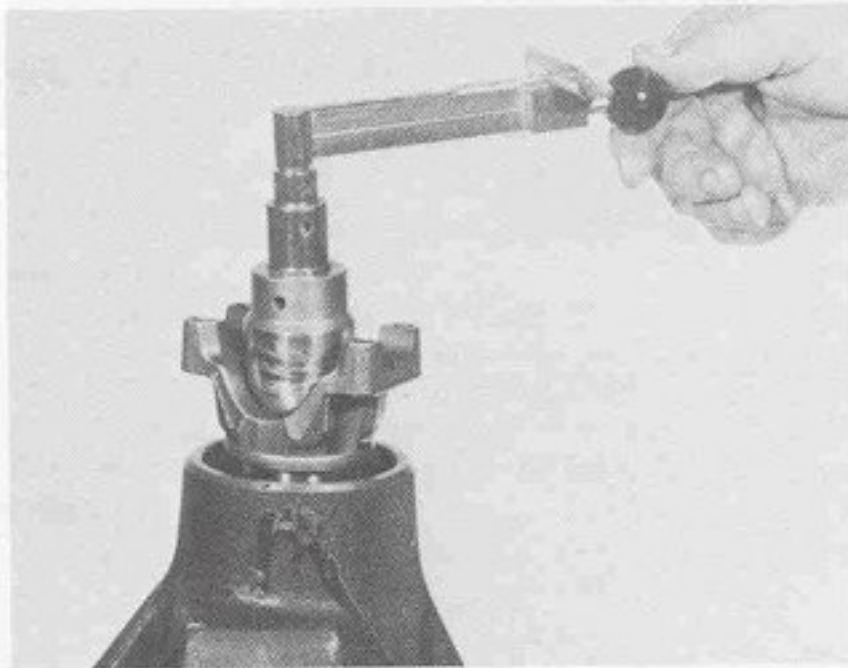

Figure 179

1019-179

Assemble washer and pinion nut. Torque nut until it requires 10 Lb. In. (1.13 N·m) to rotate the pinion. Rotate pinion several times before checking pinion position. This is to seat the bearings and assure a more accurate reading pinion depth setting.

Tool: #C-193 In.-Lb. Torque Wrench.

NOTE

The reason for not assembling preload shims and new pinion seal, at this time, is due to the possibility of having to adjust pinion preload or pinion adjustment. It would be necessary to again remove the seal and, as mentioned, whenever seals are removed, they are to be replaced with new ones, due to possible damage.

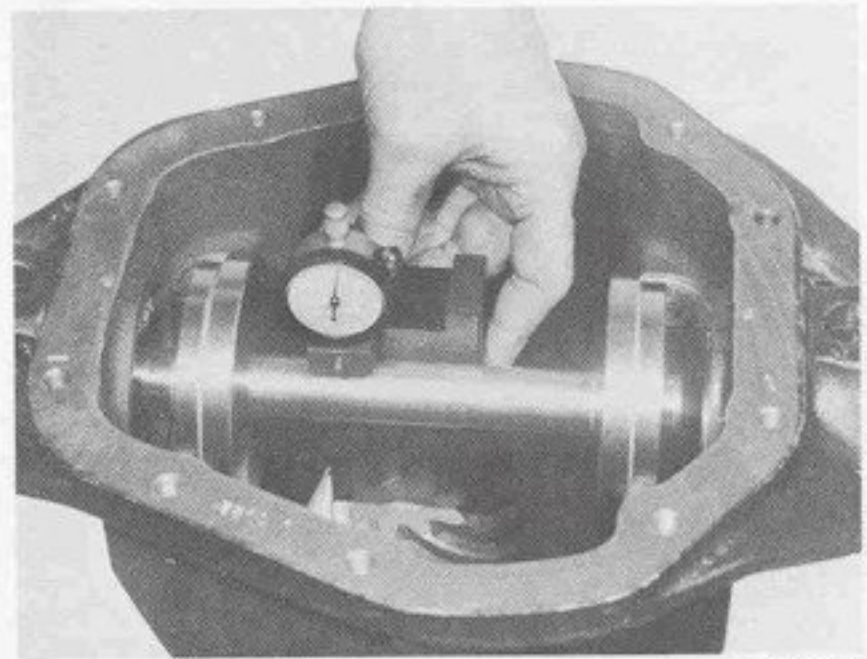

Figure 180

1019-180

Place arbor and discs (small diameter discs for Model 60 axle and large diameter used on Model 70 axle) into cross bore of carrier. Place pinion height block on button end of pinion. Set dial indicator on small step of height block (high step of block is used for Model 70 axle.) Set dial indicator at zero "0". Slide scooter gage across or over arbor.

Indicator will read a plus (+) or minus (-) at its highest point, depending on the etching of the pinion.

NOTE

Later model pinion height blocks are designed for each individual model axle. Therefore, it is possible to have a height block that does not have a step as pictured and described.

NOTE

Indicator reading within .002 (.05 mm) of etching is considered acceptable. If pinion position is found to be within specifications continue with build up. If pinion position is not within specifications change shim pack thickness under inner bearing cup.

Remove pinion nut, washer, end yoke, slinger, and bearing cone. Assemble preload shims (which were removed during disassembly) onto pinion. Assemble bearing cone, and slinger.

CARRIER SECTION

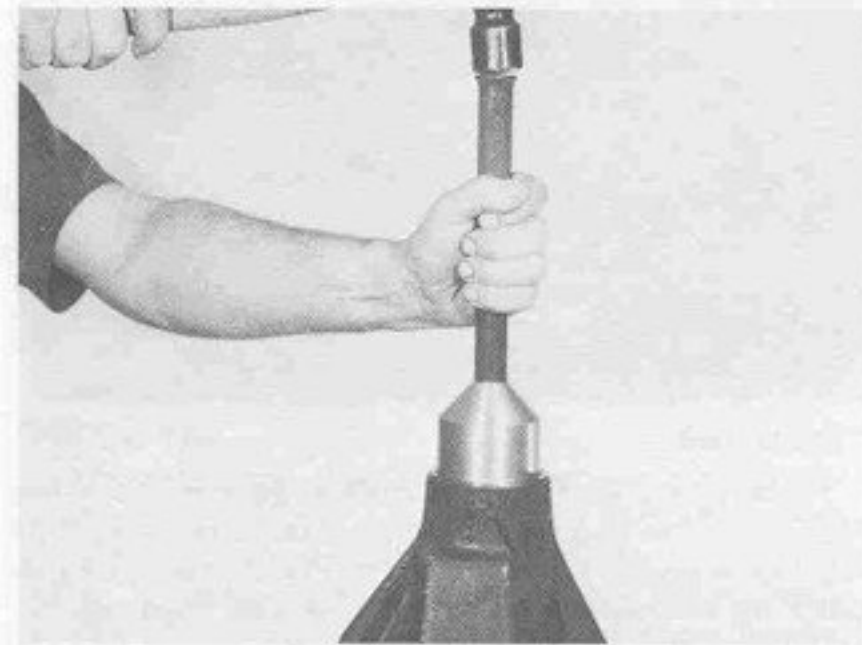

Figure 181 1019-181
Apply a light coat of hypoid lubricant on the lip of pinion seal and assemble into carrier.
Tools: #D-163 (National) Seal Installer, #D-164 (Chicago Rawhide) Seal Installer, #C-4171 Handle.

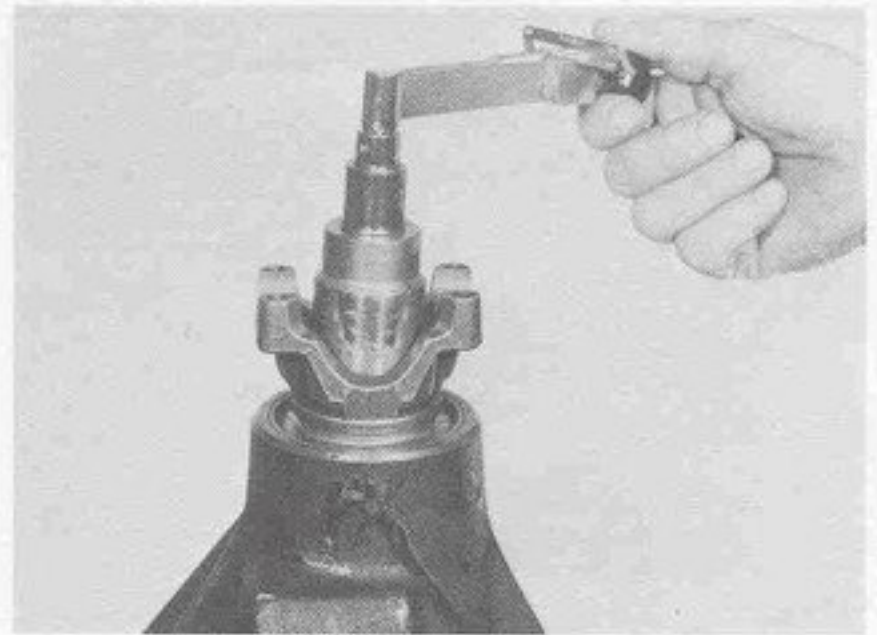

Figure 183 1019-183
Using an In. Lb. torque wrench as shown, rotate pinion. Torque to rotate pinion should read between 20-40 Lb. In. (2.26-4.53 N·m). To increase preload, remove shims; to decrease preload add shims.

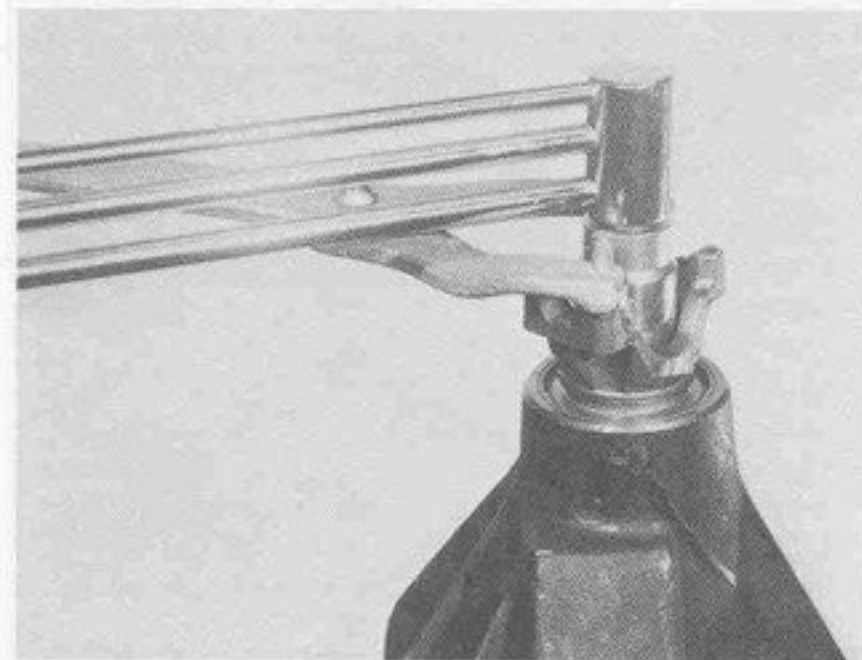

Figure 182 1019-182
Assemble end yoke, washer, and new pinion nut. Torque not to 240-300 Lb. Ft. (325-406 N·m).
Tools: #C-4053 Torque Wrench, #C-3281 Yoke Holder.

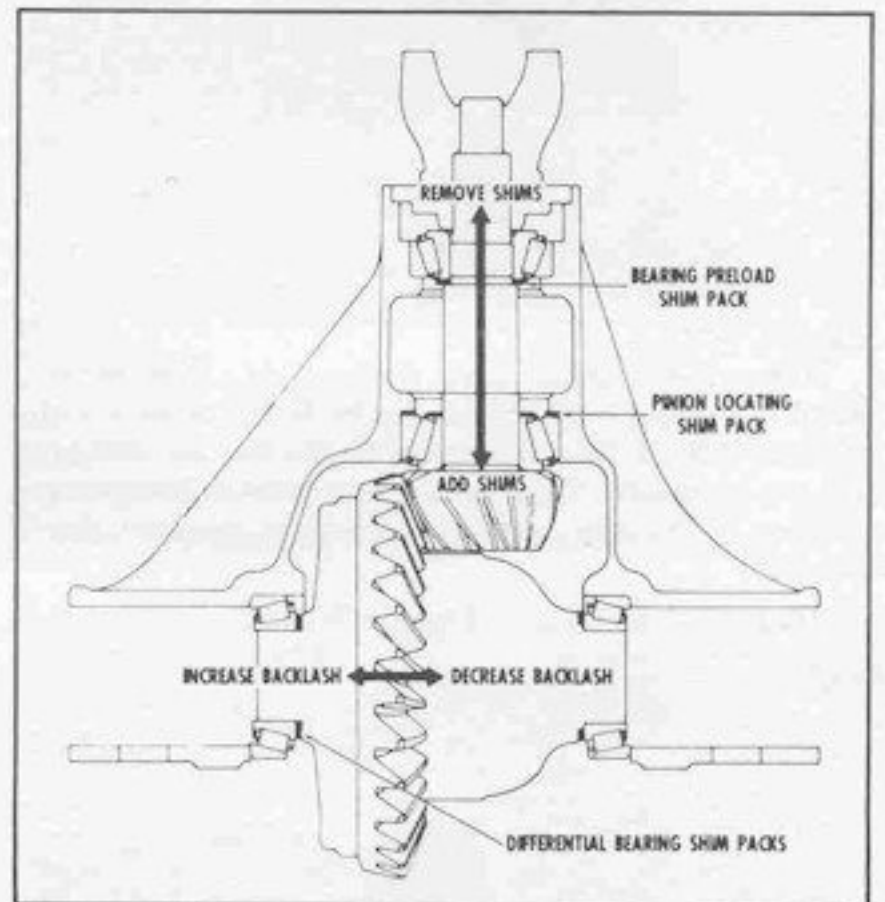

Figure 184 L/D Carrier 1019-184
The illustration in figure 184 shows the arrow in the pinion pointing in two directions. The direction pointing towards the end yoke indicates that by removing pinion position shims, the distance from the centerline of the axle to pinion button is increased giving a plus reading. The preload shim pack does not effect the pinion depth setting. Arrows on the ring gear illustrate the method to increase or decrease backlash and differential bearing preload.

CARRIER SECTION

ASSEMBLY OF DIFFERENTIAL

Place differential assembly (with pinion installed) into housing. Differential master bearings should still be assembled to case.

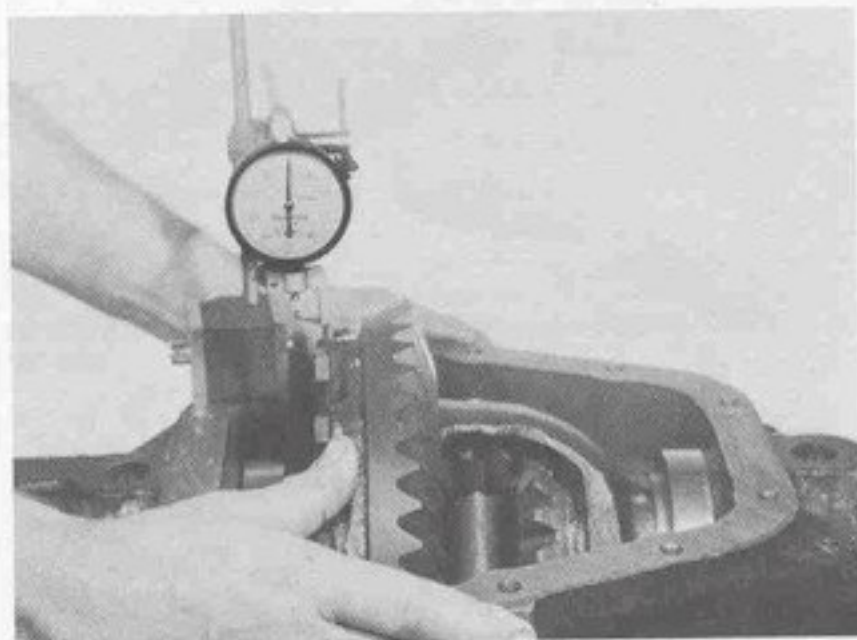

Figure 185 1019-185
Set up dial indicator as shown. Be sure to locate dial indicator on same location as marked in figure 163. Force ring gear into mesh with the pinion. Rock ring to allow the teeth of the gears to mesh. With force still applied to the differential case, set indicator at zero "0".

Tool: #D-128 Indicator.

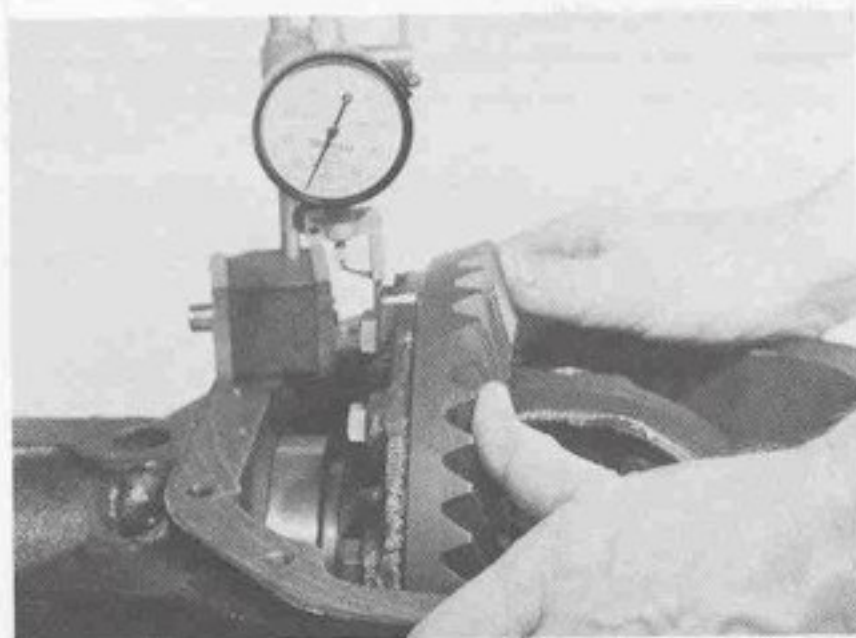

Figure 186 1019-186
Force the differential case (ring gear) away from the pinion gear to obtain an indicator reading. Repeat until the same reading is obtained each time. This reading will be the necessary amount of shims required between the differential case and differential bearings on the ring gear side. Remove indicator and differential case from the carrier. Remove master bearings from differential case.



Figure 187 1019-187
Assemble the required amount of shim onto hub (ring gear side) as determined in figure 186. Place bearing cone on hub of case. Use bearing installer to seat bearing cone as shown.

Tools: #C-4052-A Installer, #C-4171 Handle, #DD-914-42 Button.

Assemble the remaining of the total shim pack which was determined in figure 164 on the opposite side of the differential case. Add an additional .015" (.38 mm) of shims on this side to compensate for differential bearing preload. Assemble differential bearing, using the same tools as shown in figure 187.

In figure 164 (less pinion) a total of .107" indicator reading was recorded.

In figure 186 (with pinion) a total of .055" indicator reading was recorded. This leaves a balance .052" of shims for the opposite side and adds up to the .107" which was first recorded.

Add an additional .015" shims on the opposite side for bearing preload and backlash.

Ring Gear Side .055" (1.40 mm)
Opposite Side .052" (1.32 mm)
Opposite Side Preload .015" (.38 mm)

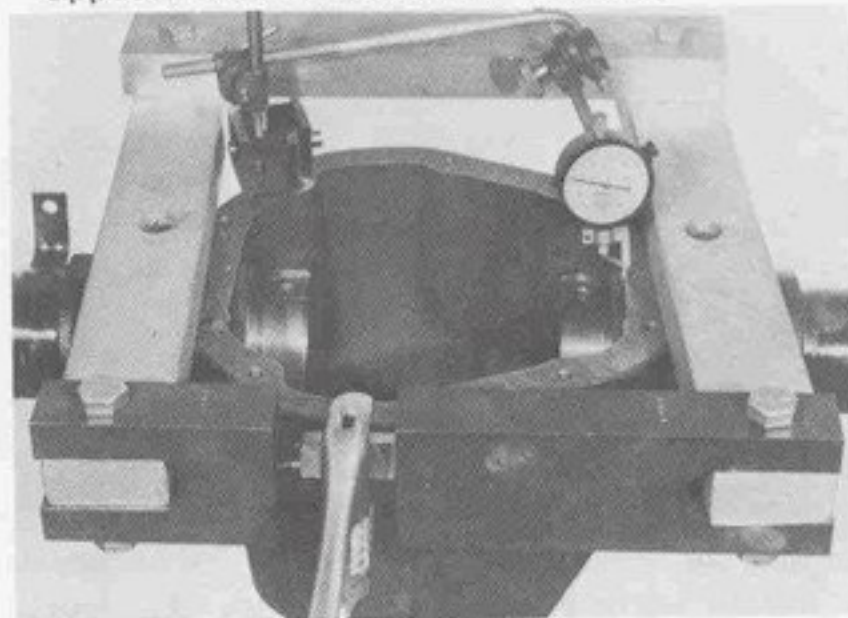

Figure 188 1019-188
Install spreader and indicator to carrier as shown. Do not spread carrier over .015 (.38 mm). Remove indicator.

CARRIER SECTION

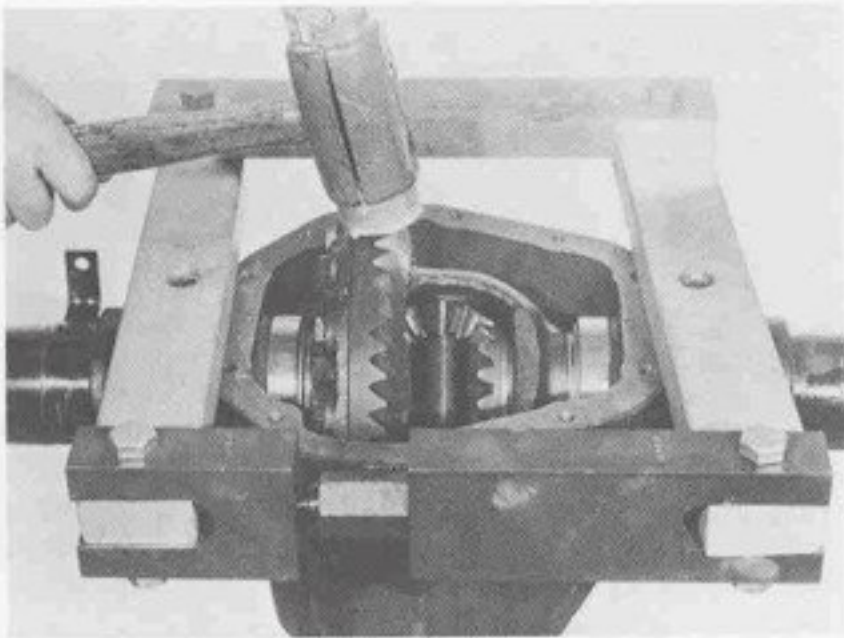

Figure 189 1019-189
Assemble differential bearing cups to differential bearing cones.
Install differential assembly into carrier.
Use a rawhide hammer to seat differential assembly into cross bore of carrier. Care should be taken to avoid nicking the teeth of the ring gear and pinion during assembly. Remove spreader.

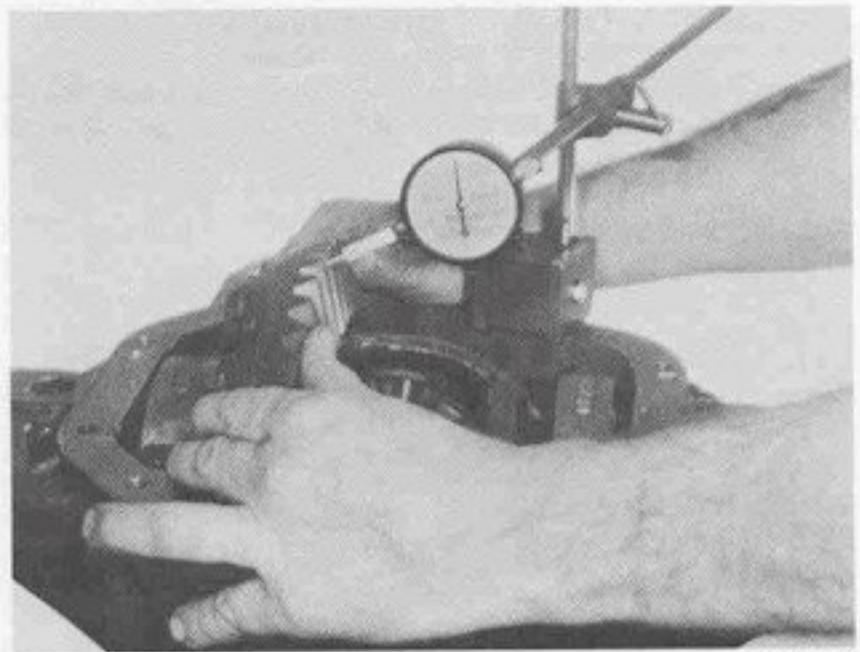

Figure 191 1019-191
Check ring gear and pinion backlash in three equally spaced points with dial indicator as shown. Backlash tolerance is .004" (mm .10-.23) to .009" and cannot vary more than .002" (mm .05) between points checked.
High backlash is corrected by moving the ring gear closer to the pinion.
Low backlash is corrected by moving ring gear away from the pinion.
These corrections are made by switching shims from one side of the differential case to the other.

NOTE

If servicing the semi-float shaft riding bearing design unit, refer to the manual section for that unit. After installing axle shafts, a new lock pin is installed.

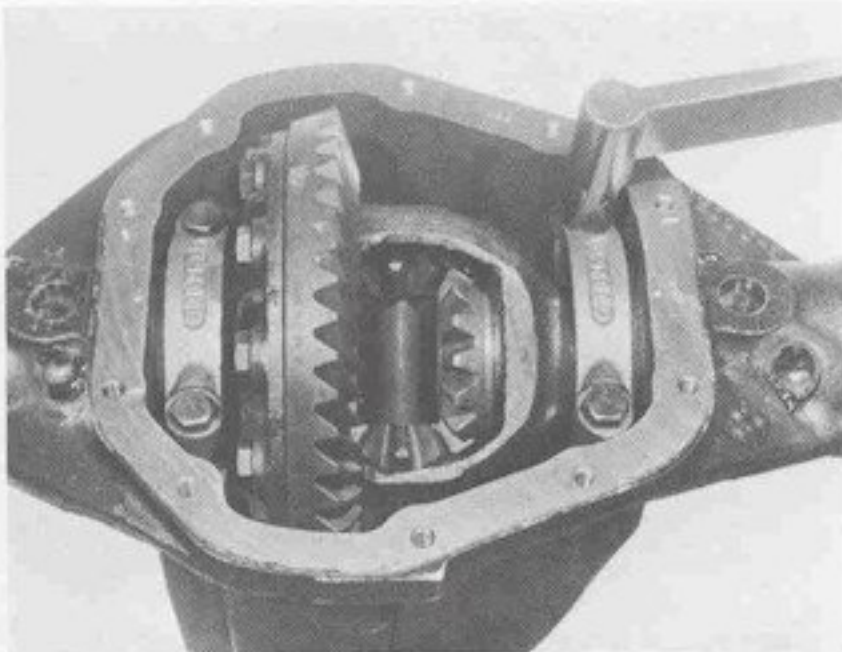

Figure 190 1019-190
Install bearing caps. Make sure the letters stamped on the caps correspond with those on the carriers. Torque bearing cap screws to 80-90 Lb. Ft. (108-122 N·m).
Tool: #C-524-A Torque Wrench.

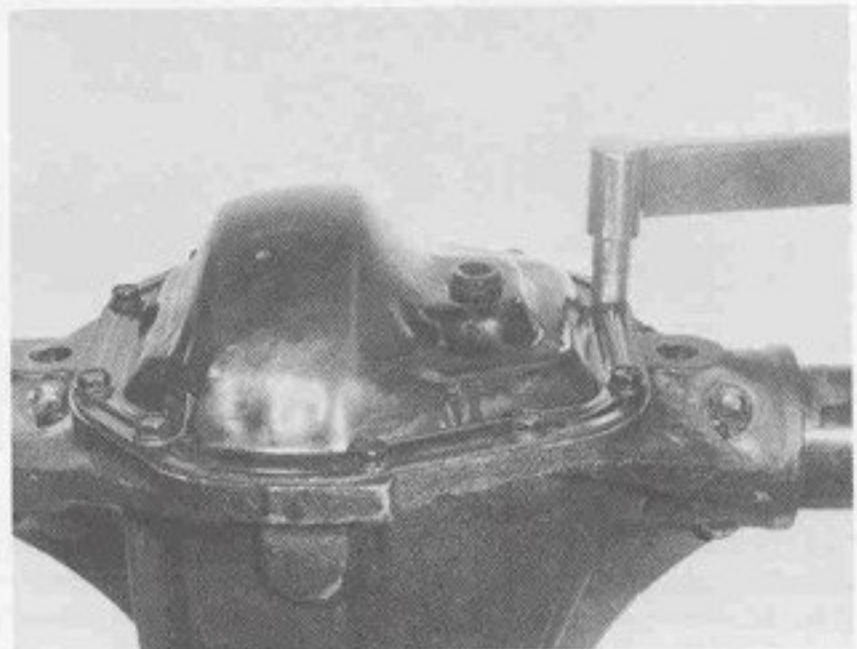

Figure 192 1019-192
Install new cover gasket and install cover plate. Torque screws to 30-40 Lb. Ft. (41-54 N·m).
Tool: #C-524-A Torque Wrench.

CARRIER SECTION

NOTE

There are two different design cover plates. One cover is of the flat mounting surface, and the other design is of the ribs between screw holes.

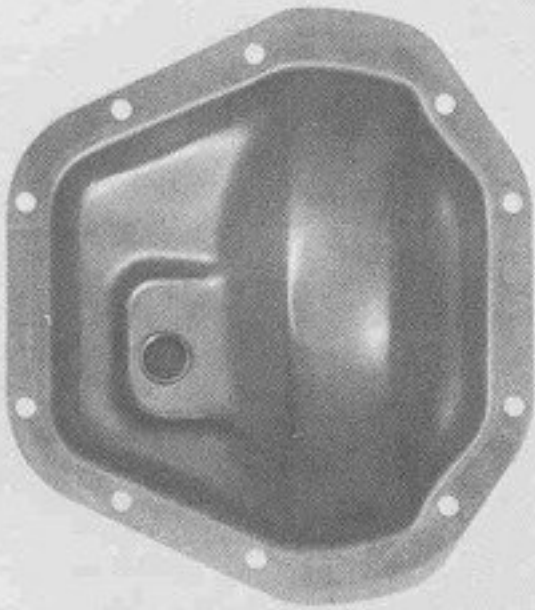

Figure 193

1019-193

Figure 193 shows the flat mounting surface cover plate on Dana design axles. This cover plate requires the use of a silicone rubber sealer material rather than a gasket.

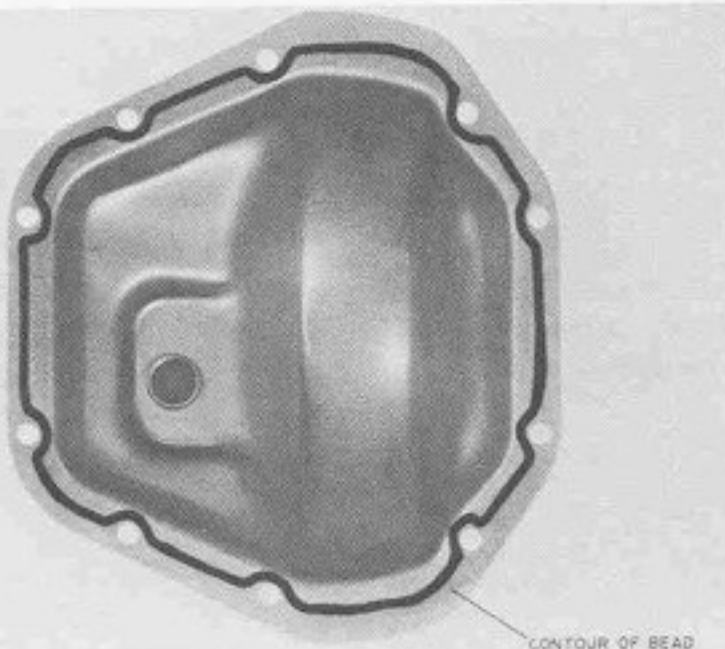

Figure 194

1019-194

The cover face of the carrier and the flat surface of the cover plate must be free of any oil film or foreign material.

Sealant material must meet specifications of ASTM3, GE303, A19, B37, E16, E36, 21, 22, and 23 sealant.

Apply sealer to cover plate surface. Ensure that the sealer bead is laid on the inside of the cover screw holes. The bead is not to pass through the holes or outside of the holes.

The bead is to be 1/8" to 1/4" (3.18 - 6.35 mm) high and 1/8" to 1/4" (3.18 - 6.35 mm) wide.

Assemble two cover screws into cover at 8 o'clock and 2 o'clock position. Use these two holes to guide cover plate into position on the carrier.

Install remaining screws. Tighten alternately and evenly. Torque screws to 30-40 Lbs. Ft. (41-54 N·m).

Allow one hour cure time before filling carrier with the proper amount of specified lubricant and vehicle operation.

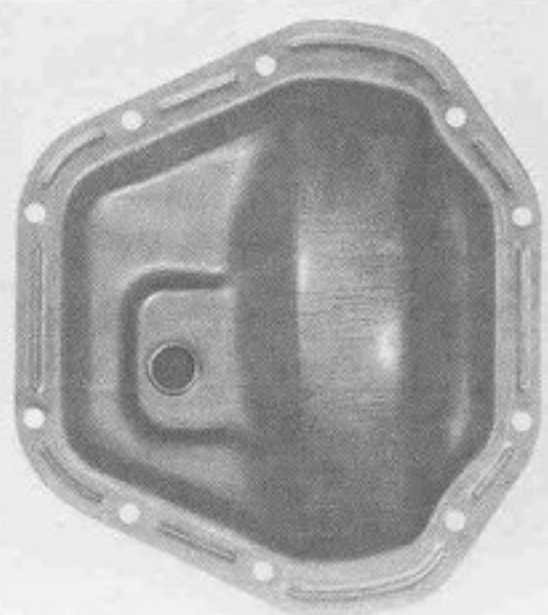

Figure 195

1019-195

On cover plate of the rib design, a gasket must be used. Do not use silicone sealer. Torque screws to 30-40 Lbs. Ft. (41-54 N·m).

For Further Information Write To:

Spicer Axle Division

Dana Corporation

P.O. Box 1209

Fort Wayne, Indiana 46801

Attention: Engineering Technical
Service Department.

Specifications, descriptions and illustrations contained in this manual are as accurate as known at the time this publication was approved for printing. Dana Corporation, Spicer Axle Division, reserves the right to make changes from time to time without notice or obligation, in specifications, descriptions, and illustrations; to discontinue models or revise designs.