

Service Manual

32 inch/37 inch Class 1080p LCD HDTV

Model No. **TC-L37S1**
TC-L32S1

LH91 Chassis

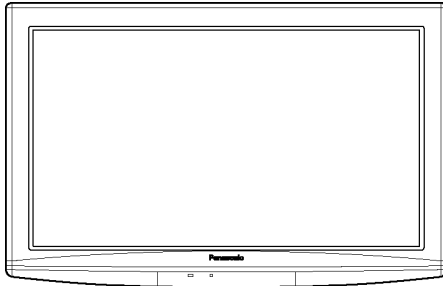

WARNING

This service information is designed for experienced repair technicians only and is not designed for use by the general public. It does not contain warnings or cautions to advise non-technical individuals of potential dangers in attempting to service a product. Products powered by electricity should be serviced or repaired only by experienced professional technicians. Any attempt to service or repair the product or products dealt with in this service information by anyone else could result in serious injury or death.

IMPORTANT SAFETY NOTICE

There are special components used in this equipment which are important for safety. These parts are marked by  in the Schematic Diagrams, Circuit Board Diagrams, Exploded Views and Replacement Parts List. It is essential that these critical parts should be replaced with manufacturer's specified parts to prevent shock, fire or other hazards. Do not modify the original design without permission of manufacturer.

1 Safety Precautions

1.1. General Guidelines

1. When servicing, observe the original lead dress. If a short circuit is found, replace all parts which have been overheated or damaged by the short circuit.
2. After servicing, see to it that all the protective devices such as insulation barriers, insulation papers shields are properly installed.
3. After servicing, make the following leakage current checks to prevent the customer from being exposed to shock hazards.
4. When servicing, observe the original lead dress. If a short circuit is found, replace all parts which have been overheated or damaged by the short circuit.
5. After servicing, see to it that all the protective devices such as insulation barriers, insulation papers shields are properly installed.
6. After servicing, make the following leakage current checks to prevent the customer from being exposed to shock hazards.

1.1.1. Leakage Current Cold Check

1. Unplug the AC cord and connect a jumper between the two prongs on the plug.
2. Measure the resistance value, with an ohmmeter, between the jumpered AC plug and each exposed metallic cabinet part on the equipment such as screwheads, connectors, control shafts, etc. When the exposed metallic part has a return path to the chassis, the reading should be 100 Mohm and over.

When the exposed metal does not have a return path to the chassis, the reading must be ∞ .

1.1.2. Leakage Current Hot Check (See Figure 1.)

1. Plug the AC cord directly into the AC outlet. Do not use an isolation transformer for this check.
2. Connect a 1.5kohm, 10 watts resistor, in parallel with a 0.15 μ F capacitors, between each exposed metallic part on the set and a good earth ground such as a water pipe, as shown in Figure 1.
3. Use an AC voltmeter, with 1000 ohms/volt or more sensitivity, to measure the potential across the resistor.
4. Check each exposed metallic part, and measure the voltage at each point.
5. Reverse the AC plug in the AC outlet and repeat each of the above measurements.
6. The potential at any point should not exceed 0.75 volts RMS. A leakage current tester (Simpson Model 229 or equivalent) may be used to make the hot checks, leakage current must not exceed 1/2 milliamp. In case a measurement is outside of the limits specified, there is a possibility of a shock hazard, and the equipment should be repaired and rechecked before it is returned to the customer.

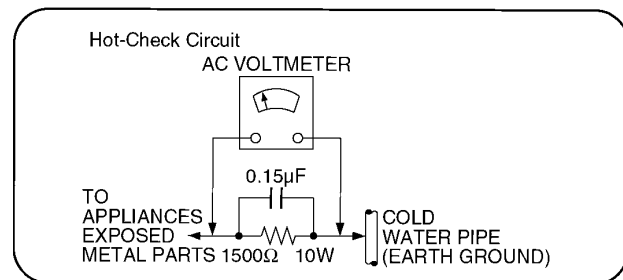

Figure 1

2 Warning

2.1. Prevention of Electrostatic Discharge (ESD) to Electrostatically Sensitive (ES) Devices

Some semiconductor (solid state) devices can be damaged easily by static electricity. Such components commonly are called Electrostatically Sensitive (ES) Devices. Examples of typical ES devices are integrated circuits and some field-effect transistors and semiconductor [chip] components. The following techniques should be used to help reduce the incidence of component damage caused by electrostatic discharge (ESD).

1. Immediately before handling any semiconductor component or semiconductor-equipped assembly, drain off any ESD on your body by touching a known earth ground. Alternatively, obtain and wear a commercially available discharging ESD wrist strap, which should be removed for potential shock reasons prior to applying power to the unit under test.
2. After removing an electrical assembly equipped with ES devices, place the assembly on a conductive surface such as aluminum foil, to prevent electrostatic charge buildup or exposure of the assembly.
3. Use only a grounded-tip soldering iron to solder or unsolder ES devices.
4. Use only an anti-static solder removal device. Some solder removal devices not classified as [anti-static (ESD protected)] can generate electrical charge sufficient to damage ES devices.
5. Do not use freon-propelled chemicals. These can generate electrical charges sufficient to damage ES devices.
6. Do not remove a replacement ES device from its protective package until immediately before you are ready to install it. (Most replacement ES devices are packaged with leads electrically shorted together by conductive foam, aluminum foil or comparable conductive material).
7. Immediately before removing the protective material from the leads of a replacement ES device, touch the protective material to the chassis or circuit assembly into which the device will be installed.

Caution

Be sure no power is applied to the chassis or circuit, and observe all other safety precautions.

8. Minimize bodily motions when handling unpackaged replacement ES devices. (Otherwise ham less motion such as the brushing together of your clothes fabric or the lifting of your foot from a carpeted floor can generate static electricity (ESD) sufficient to damage an ES device).

2.2. About lead free solder (PbF)

Note: Lead is listed as (Pb) in the periodic table of elements.

In the information below, Pb will refer to Lead solder, and PbF will refer to Lead Free Solder.

The Lead Free Solder used in our manufacturing process and discussed below is (Sn+Ag+Cu).

That is Tin (Sn), Silver (Ag) and Copper (Cu) although other types are available.

This model uses Pb Free solder in it's manufacture due to environmental conservation issues. For service and repair work, we'd suggest the use of Pb free solder as well, although Pb solder may be used.

PCBs manufactured using lead free solder will have the PbF within a leaf Symbol **PbF** stamped on the back of PCB.

Caution

- Pb free solder has a higher melting point than standard solder. Typically the melting point is 50 ~ 70 °F (30~40 °C) higher. Please use a high temperature soldering iron and set it to 700 ± 20 °F (370 ± 10 °C).
- Pb free solder will tend to splash when heated too high (about 1100 °F or 600 °C).
If you must use Pb solder, please completely remove all of the Pb free solder on the pins or solder area before applying Pb solder. If this is not practical, be sure to heat the Pb free solder until it melts, before applying Pb solder.
- After applying PbF solder to double layered boards, please check the component side for excess solder which may flow onto the opposite side. (see figure below)

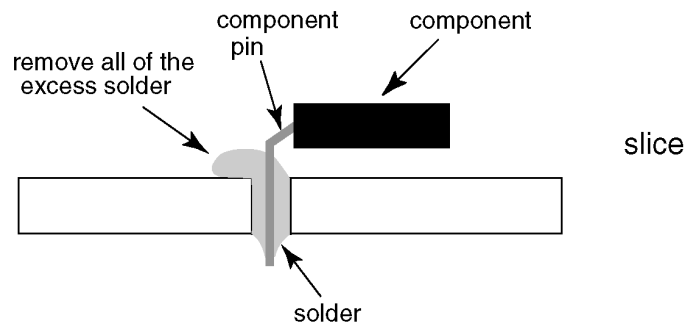

Suggested Pb free solder

There are several kinds of Pb free solder available for purchase. This product uses Sn+Ag+Cu (tin, silver, copper) solder. However, Sn+Cu (tin, copper), Sn+Zn+Bi (tin, zinc, bismuth) solder can also be used.

0.3mm X 100g	0.6mm X 100g	1.0mm X 100g

3 Service Navigation

3.1. Service Hint

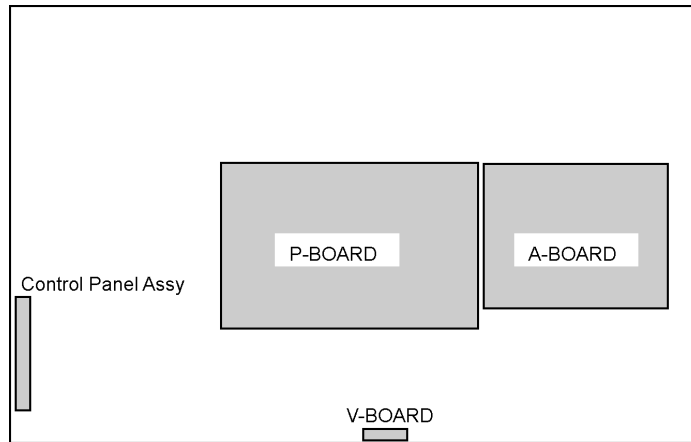

Board Name	Function
A-Board	Rear Terminal, AV Switch, MCU, Audio & Video Processor, LVDS, Tuner
V-Board	Remote Receiver, LED
P-Board	Power (AC/DC), DC-DC None serviceable P-Board should be exchanged for service.
Control Panel Assy	Control Button, Power switch None serviceable Control Panel Assy should be exchanged for service.

3.2. Applicable signals

Input signal that can be displayed

* Mark: Applicable input signal for Component (Y, P_B, P_R), HDMI and PC

	horizontal frequency (kHz)	vertical frequency (Hz)	COMPONENT	HDMI	PC
525 (480) / 60i	15.73	59.94	*	*	
525 (480) /60p	31.47	59.94	*	*	
750 (720) /60p	45.00	59.94	*	*	
1,125 (1,080) /60i	33.75	59.94	*	*	
1,125 (1,080) /60p	67.43	59.94		*	
1,125 (1,080) /60	67.50	60.00		*	
1,125 (1,080) /24p	26.97	23.98		*	
1,125 (1,080) /24p	27.00	24.00		*	
640 × 400 @70	31.47	70.08			*
640 × 480 @60	31.47	59.94			*
Macintosh13 inch (640 × 480)	35.00	66.67			*
640 × 480 @75	37.50	75.00			*
852 × 480 @60	31.47	59.94			*
800 × 600 @60	37.88	60.32			*
800 × 600 @75	46.88	75.00			*
800 × 600 @85	53.67	85.08			*
Macintosh16 inch (832 × 624)	49.73	74.55			*
1,024 × 768 @60	48.36	60.00			*
1,024 × 768 @70	56.48	70.07			*
1,024 × 768 @75	60.02	75.03			*
1,024 × 768 @85	68.68	85.00			*
Macintosh 21 inch (1,152 × 870)	68.68	75.06			*
1,280 × 768 @60	47.70	60.00			*
1,280 × 1,024 @60	63.98	60.02			*
1,366 × 768 @60	48.36	60.00			*

Note:

- Signals other than above may not be displayed properly.
- The above signals are reformatted for optimal viewing on your display.

4 Specifications

Power Source	AC 110-127 V, 60 Hz	
Power Consumption		
Maximum	123 W (TC-L32S1) 151 W (TC-L37S1)	
Standby Condition	0.2 W (TC-L32S1) 0.2 W (TC-L37S1)	
Display panel		
Aspect Ratio	16:9	
Visible screen size	32 inch class (31.5 inches measured diagonally) (TC-L32S1) 37 inch class (37.0 inches measured diagonally) (TC-L37S1)	
(W × H × Diagonal)	27.5 inch × 15.4 inch × 31.5 inch (698 mm × 392 mm × 801 mm) (TC-L32S1) 32.2 inch × 18.1 inch × 37.0 inch (819 mm × 460 mm × 940 mm) (TC-L37S1)	
(No. of pixels)	2,073,600 (1,920 (W) × 1,080(H)) [5,760 × 1,080 dots]	
Sound		
Speaker	1-way 2 speakers slim under SP System	
Audio Output	20 W [10 W + 10 W] (10 % THD)	
Headphones	M3 (3.5 mm) Jack × 1	
PC signals	VGA, SVGA, XGA, WXGA, SXGA Horizontal scanning frequency 31 - 69 kHz Vertical scanning frequency 59 - 86 Hz	
Channel Capability- ATSC/NTSC (Digital/Analog)	VHF/ UHF: 2 - 69, CATV: 1 - 135	
Operating Conditions	Temperature:	32 °F - 95 °F (0 °C - 35°C)
	Humidity:	20 % - 80 % RH (non-condensing)
Connection Terminals		
VIDEO IN 1	VIDEO:	RCA PIN Type × 1 1.0 V [p-p] (75 Ω)
	AUDIO L - R:	RCA PIN Type × 2 0.5 V [rms]
VIDEO IN 2	VIDEO:	RCA PIN Type × 1 1.0 V[p-p] (75 Ω)
	S VIDEO:	Mini DIN 4-pin Y: 1.0 V[p-p] (75 Ω) C: 0.286 V [p-p] (75 Ω)
	AUDIO L - R:	RCA PIN Type × 2 0.5 V [rms]
COMPONENT IN 1	Y:	1.0 V [p-p] (including synchronization)
	PB, PR:	±0.35 V [p-p]
	AUDIO L-R:	RCA PIN Type × 2 0.5 V [rms]
HDMI 1-3	TYPE A Connector × 3 . ● This TV supports [HDAVI Control 4] function.	
PC	D-SUB 15PIN:	R,G,B / 0.7 V [p-p] (75 Ω) HD, VD / 1.0 - 5.0 V [p-p] (high impedance)
Card slot	SD CARD slot × 1	
DIGITAL AUDIO OUT	PCM / Dolby Digital, Fiber Optic	
FEATURES	3D Y/C Digital Comb Filter, CLOSED CAPTION, V-Chip HDMI (HDAVI Control 4) Vesa compatible, Photo viewer	
Dimensions (W × H × D)		
Including TV stand	31.5 inch × 21.7 inch × 8.6 inch (798 mm × 551 mm × 217 mm) (TC-L32S1) 36.1 inch × 24.5 inch × 11.3 inch (915 mm × 620 mm × 287 mm) (TC-L37S1)	
TV Set only	31.5 inch × 20.2 inch × 3.7 inch (798 mm × 511 mm × 93 mm) (TC-L32S1) 36.1 inch × 22.8 inch × 3.9 inch (915 mm × 577 mm × 97 mm) (TC-L37S1)	
Mass		
Including TV stand	29.3 lb. (13.3 kg) NET (TC-L32S1) 37.0 lb. (16.8 kg) NET (TC-L37S1)	
TV Set only	25.6 lb. (11.6) NET (TC-L32S1) 32.0 lb. (14.5) NET (TC-L37S1)	

Note

Design and Specifications are subject to change without notice. Mass and Dimensions shown are approximate.

5 Service Mode

5.1. How to enter into Service Mode

While pressing [VOLUME (-)] button of the main unit, press [INFO] button of the remote control three times within 2 seconds.

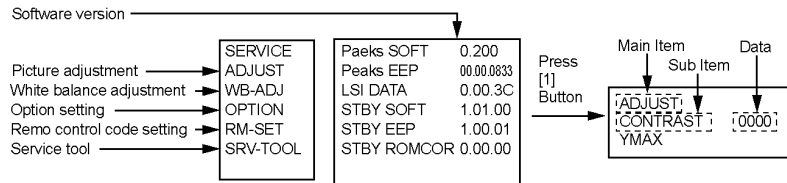

5.1.1. Key command

- [1] button...Main items Selection in forward direction
- [2] button...Main items Selection in reverse direction
- [3] button...Sub items Selection in forward direction
- [4] button...Sub items Selection in reverse direction
- [VOL] button...Value of sub items change in forward direction (+), in reverse direction (-)

5.1.2. Contents of adjustment mode

- Value is shown as a hexadecimal number.
- Preset value differs depending on models.
- After entering the adjustment mode, take note of the value in each item before starting adjustment.

Main item	Sub item	Sample Data	Remark
ADJUST	CONTRAST	000	
	COLOR	4C	
	TINT	00	
	SUB-BRT	808	
	BACKLGT	4CB	
	B-Y-G	34	
	R-Y-A	00	
WB-ADJ	R-GAIN	F2	
	G-GAIN	FC	
	B-GAIN	E6	
	R-CENT	84	
	G-CENT	80	
	B-CENT	7A	
OPTION	Boot	ROM	Factory Preset.
	STBY-SET	00	
	EMERGENCY	ON	
	CLK MODE	00	
	CLOCK	FCA	
RM-SET	CODE	00	Fixed.
SRV-TOOL		00	See next.

5.1.3. How to exit

Switch off the power with the [POWER] button on the main unit or the [POWER] button on the remote control.

5.2. SRV-TOOL

5.2.1. How to access

1. Select [SRV-TOOL] in Service Mode.
2. Press [OK] button on the remote control.

SRV-TOOL		
Display of TD2Microcode version →	TD2Microcode:81c00011	
Display of Flash ROM maker code →	Flash ROM : 1 - 227E	
Display of SOS History →	PTCT : 00 . 00 . 00 . 00 . 00	Time 000040:40 Count 0000049 ← POWER ON TIME/COUNT Press [MUTE] button (3sec)

5.2.2. Display of SOS History

SOS History (Number of LED blinking) indication.

From left side; Last SOS, before Last, three occurrence before, 2nd occurrence after shipment, 1st occurrence after shipment.

This indication except 2nd and 1st occurrence after shipment will be cleared by [Self-check indication and forced to factory shipment setting].

5.2.3. POWER ON TIME/COUNT

Note : To display TIME/COUNT menu, highlight position, then press MUTE for 3sec.

Time : Cumulative power on time, indicated hour : minute by decimal

Count : Number of ON times by decimal

Note : This indication will not be cleared by either of the self-checks or any other command.

5.2.4. Exit

1. Disconnect the AC cord from wall outlet.

5.3. Hotel mode

1. Purpose
Restrict a function for hotels.
2. Access command to the Hotel mode setup menu
In order to display the Hotel mode setup menu, please enter the following command (**within 2 second**).
[TV] : Vol. [Down] + [REMOTE] : INPUT (3 times)

Then, the Hotel mode setup menu is displayed.

Hotel Mode

Mode	Off
Input	---
Channel	---
Volume	+ 25
Vol. Max	+ 100
OSD Ctrl	Off
FP Ctrl	Off
Pow Ctrl	Off

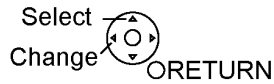

3. To exit the Hotel mode setup menu
Disconnect AC power cord from wall outlet.
4. Explain the Hotel mode setup menu

item	Function
Mode	Select hotel mode off/on
Input	Select input signal modes. Set the input, when each time power is switched on. Selection: -/RF/Component/HDMI1/HDMI2/HDMI3/Video1/Video2/PC • Off: give priority to a last memory.
Channel	Select channel when input signal is RF. Set the channel, each time power is switched on. Selection: Any channel number or [-]. [-] means the channel when turns off.
Volume	Adjust the volume when each time power is switched on. Range: 0 to 100
Vol. Max	Adjust maximum volume. Range: 0 to 100
OSD Ctrl	Restrict the OSD. Selection: Off/Pattern1 • OFF: No restriction • Pattern1: restriction
FP Ctrl	Select front key conditions. Selection: Off/Pattern1/All • Off: altogether valid. • Pattern1: only input key is valid. • All: altogether invalid.
Pow Ctrl	Select POWER-ON/OFF condition when AC power cord is disconnected and then connected. OFF: The same condition when AC power cord is disconnected. ON: Forced power ON condition.

6 Troubleshooting Guide

Use the self-check function to test the unit.

1. Checking the IIC bus lines
2. Power LED Blinking timing

6.1. Check of the IIC bus lines

6.1.1. How to access

Self-check indication only:

Produce TV reception screen, and while pressing [VOLUME (-)] button on the main unit, press [OK] button on the remote control for more than 3 seconds.

Self-check indication and forced to factory shipment setting:

Produce TV reception screen, and while pressing [VOLUME (-)] button on the main unit, press [MENU] button on the remote control for more than 3 seconds.

6.1.2. Exit

Disconnect the AC cord from wall outlet.

6.1.3. Screen display

SELF CHECK		---- . XXXXXX - XXXXXX
PEAKS	OK	
TUN1	OK	
TUN2	OK	
FE	OK	
AVSW	OK	
ADV	OK	
ADAV	OK	
GenX	OK	
MEM1	OK	
MEM2	OK	
Copyright Panasonic Corporation 2009.		

6.1.4. Check Point

Confirm the following parts if NG was displayed.

DISPLAY	Ref. No.	Description	P.C.B.
PEAKS	IC8001	PEAKS	A-Board
TUN1	TU8300	TUNER (PLL block)	A-Board
TUN2	TU8300	TUNER (MTS block)	A-Board
FE	IC8300	FRONTEND (Digital demodulator)	A-Board
AVSW	IC3001	AUDIO/VIDEO SW	A-Board
ADV	IC4510	A/D CONV., HDMI RX	A-Board
ADAV	IC4510	AUDIO DSP	A-Board
GenX	IC1102	GenX5 (STB MCU)	A-Board
MEM1	IC1103	EEPROM (GenX5)	A-Board
MEM2	IC8503	EEPROM (Peaks)	A-Board

6.2. Power LED Blinking timing chart

1. Subject

Information of LED Flashing timing chart.

2. Contents

When an abnormality has occurred the unit, the protection circuit operates and reset to the stand by mode. At this time, the defective block can be identified by the number of blinks of the Power LED on the front panel of the unit.

Blinking Times	Blinking timing	Contents	Check point
1		INVERTER SOS	LCD PANEL
3		SOS (DTV 12V / TUNER 6V / P17V)	P-Board
4		DTV 12V	P-Board
5		MAIN 9V SUB 9V	P-Board
6		SUB 5V	A-Board
7		MAIN 3.3V SUB 3.3V	A-Board
9		SOUND SOS P17V	A-Board P-Board
13		EMERGENCY SOS (Communication Error between IC8001 and IC1102)	A-Board

6.3. No Power

First check point

There are following 2 states of No Power indication by power LED.

1. No lit
2. Red is lit then turns red blinking a few seconds later. (See 6.2.)

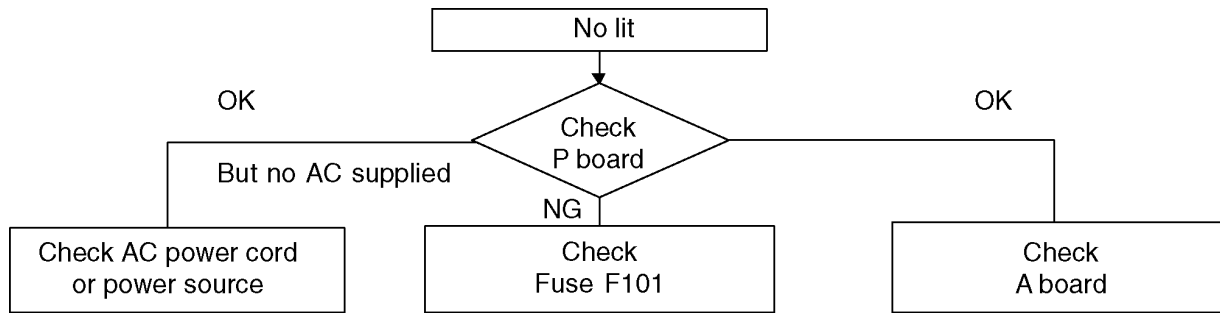

7 Disassembly and Assembly Instructions

7.1. Pedestal assy

1. Lay down the unit so that the rear cover faces upward.
2. Remove the 4 screws.
3. Remove the pedestal assy.

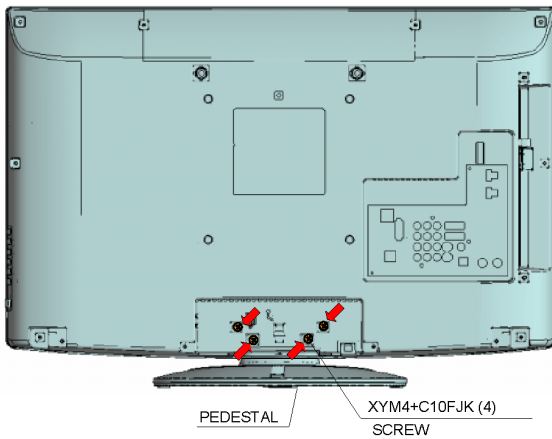

7.2. Rear cover

1. Remove the 15 screws (A).
2. Remove the 2 screws (B).
3. Remove the rear cover.

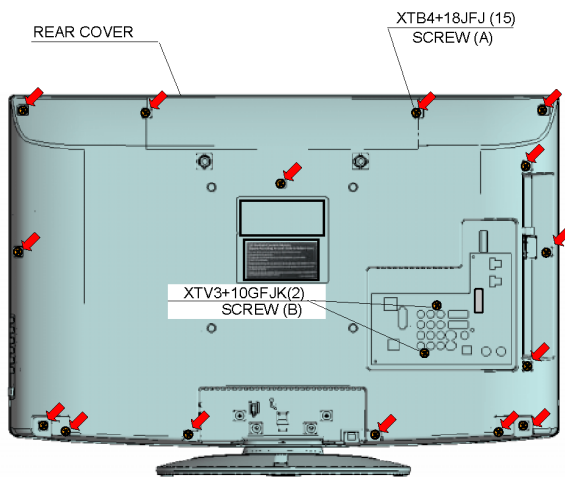

7.3. AC cord

1. Remove the bushing of the AC cord from the AC cord cover.
2. Disconnect the connector (P1) of AC cord.
3. Remove the 1 screw and AC cord cover.

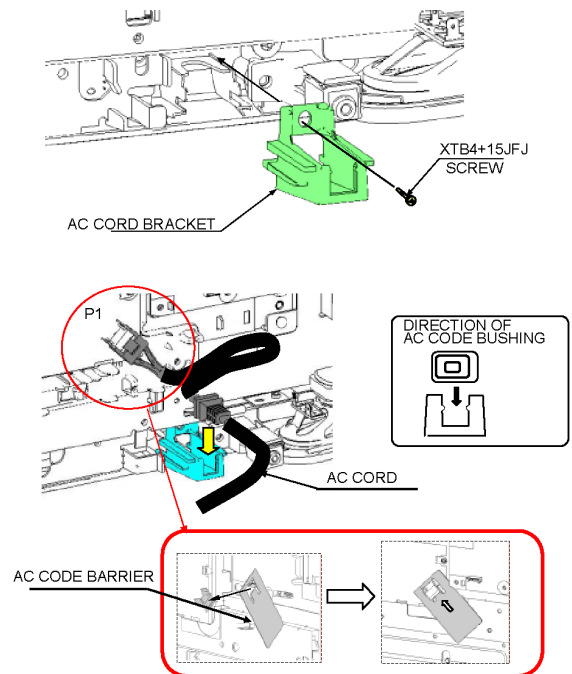

7.4. P-Board

1. Remove the 5 screws.
2. Disconnect the connectors (P1/P2/P4/P5/P6).
3. Remove the P-Board.

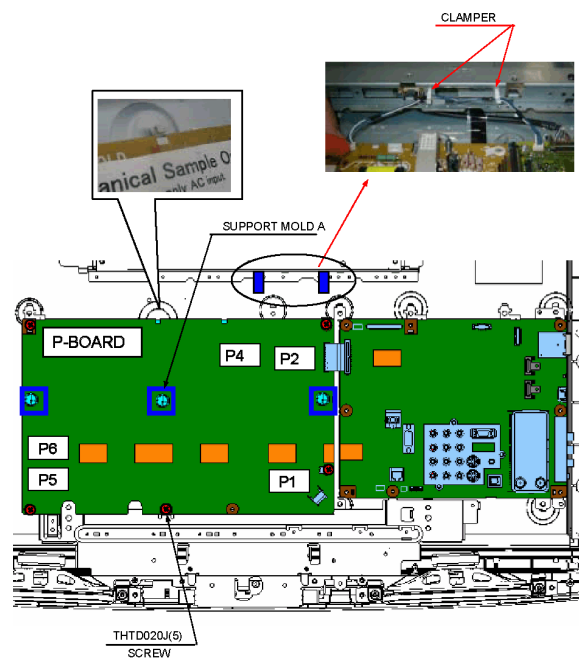

7.5. Side AV bracket

1. Remove the screw (C).
2. Remove the screw (D).
3. Remove the side AV bracket.

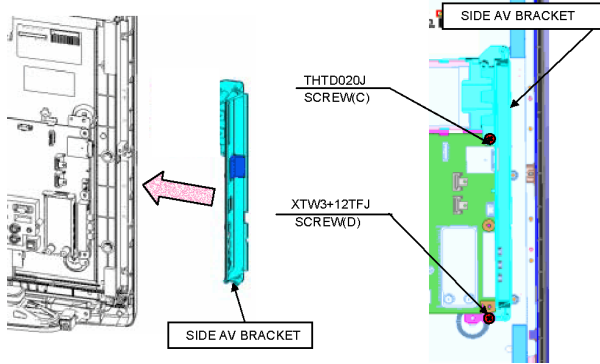

7.6. A-Board

1. Remove the 7 screws.
2. Disconnect the connector (A02/A03/A10/A11/A15/A20).
3. Remove the A-Board.

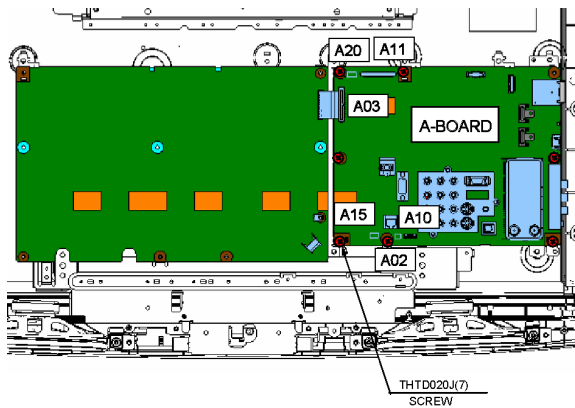

7.7. Control panel assy

1. Disconnect the connector (K1).
2. Remove the 2 screws.
3. Remove the control panel.

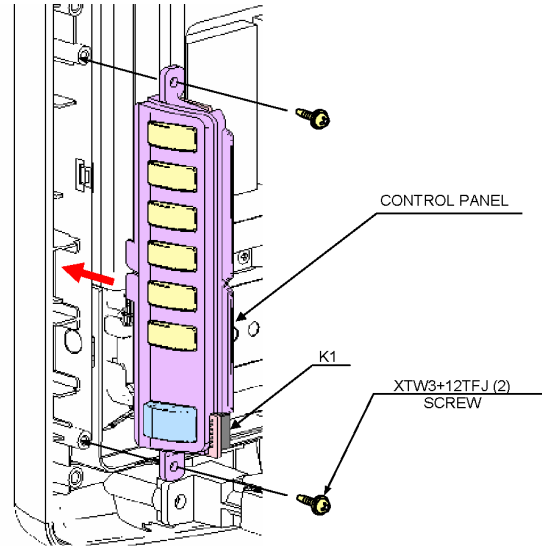

7.8. Speaker

1. Remove the 4 screws.
2. Remove the Speaker.

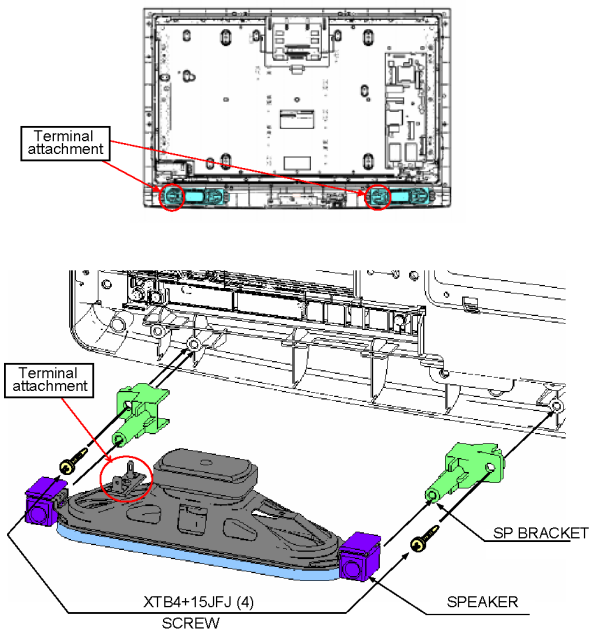

7.9. A-P-MTG Metal

1. Remove the 6 screws.
2. Remove the A-P-MTG Metal.

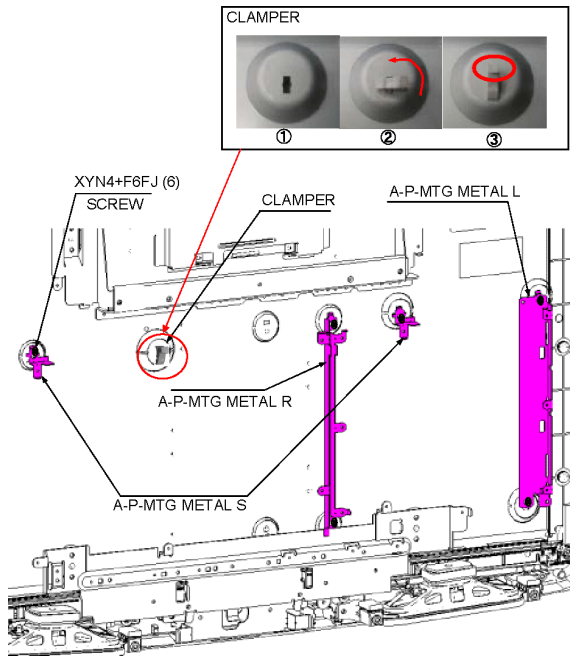

7.10. VESA metal

1. Remove the 4 screws (A).
2. Remove the 4 screws (B).
3. Remove the VESA metal.

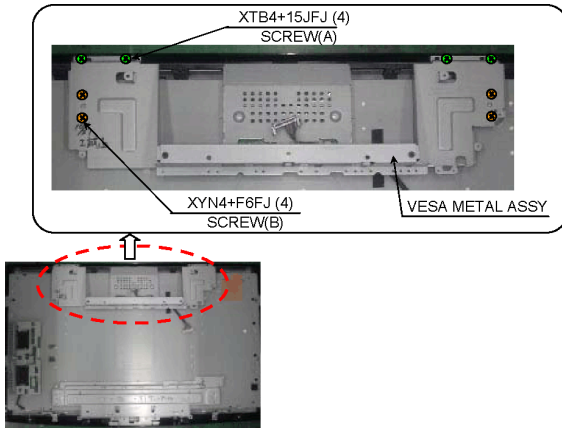

7.11. LCD MTG

1. Remove the 4 screws (G).
2. Remove the 4 screws (H).
3. Remove the LCD BTM MTG and LCD bottom corner BTG.

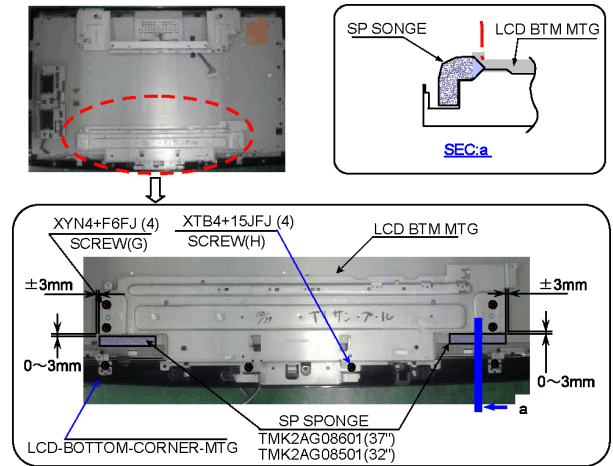

7.12. LCD Panel

1. Remove the 4 screws.
2. Remove the LCD panel and LCD side MTG.

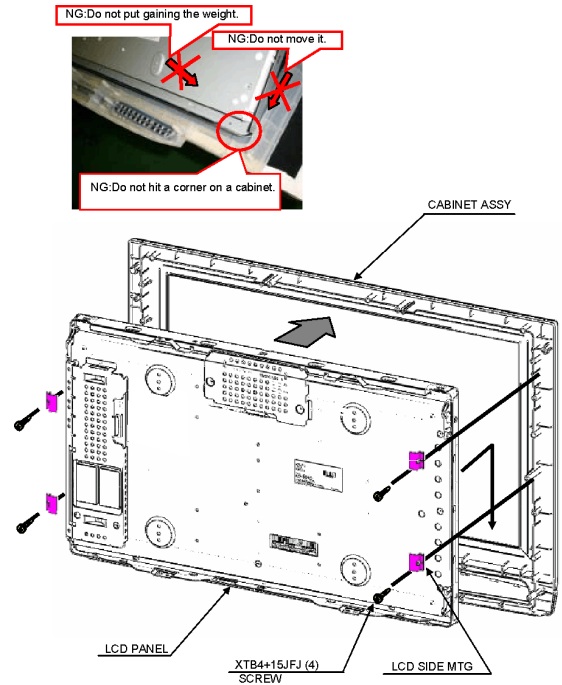

7.13. V-Board

1. Remove the 1 screw.
2. Disconnect the connector (V10).
3. Remove the V-Board.

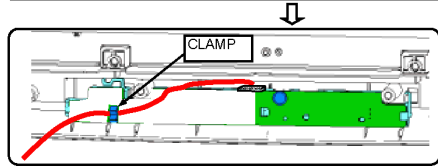
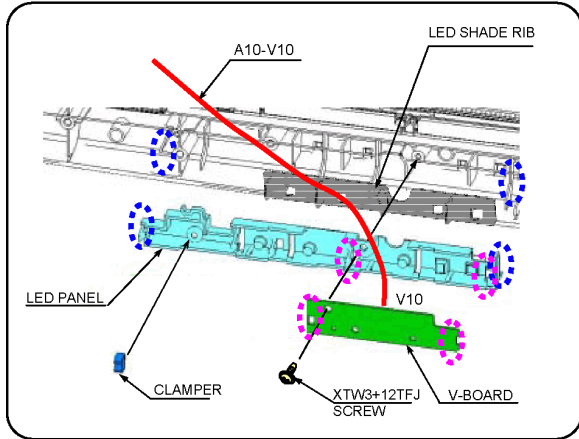
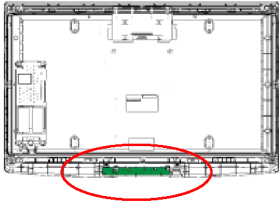

7.14. EMI processing (37 inch)

TC-L37S1

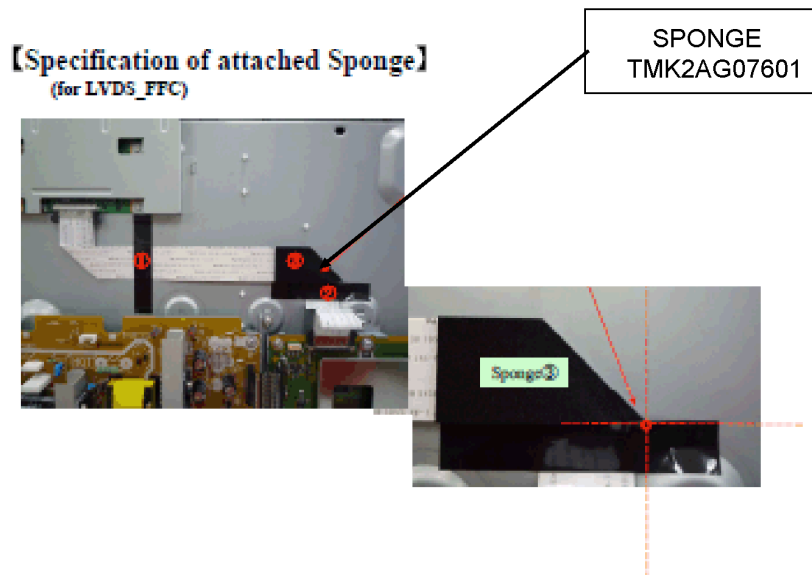
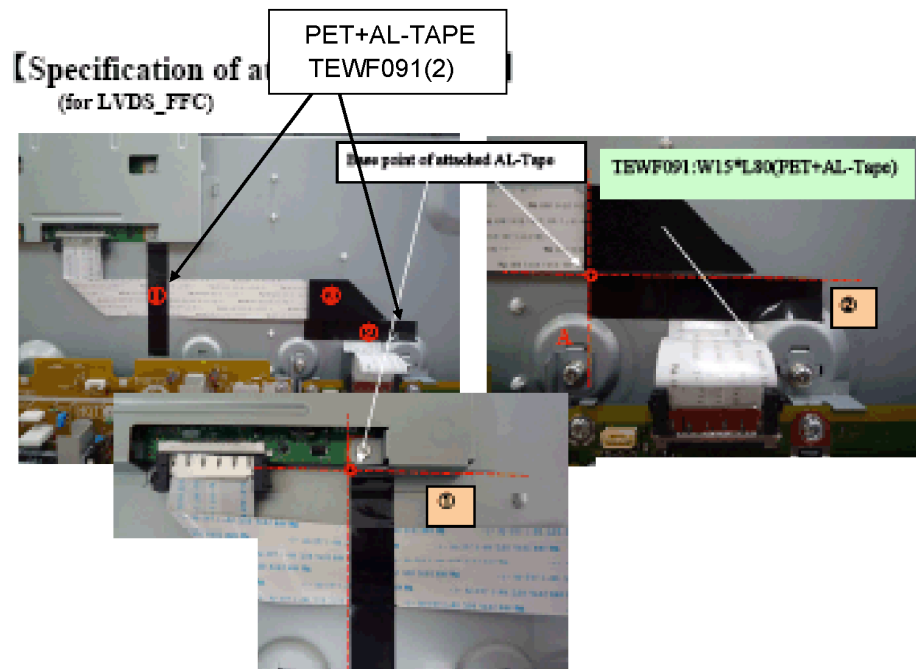

【Specification of attached Gasket】

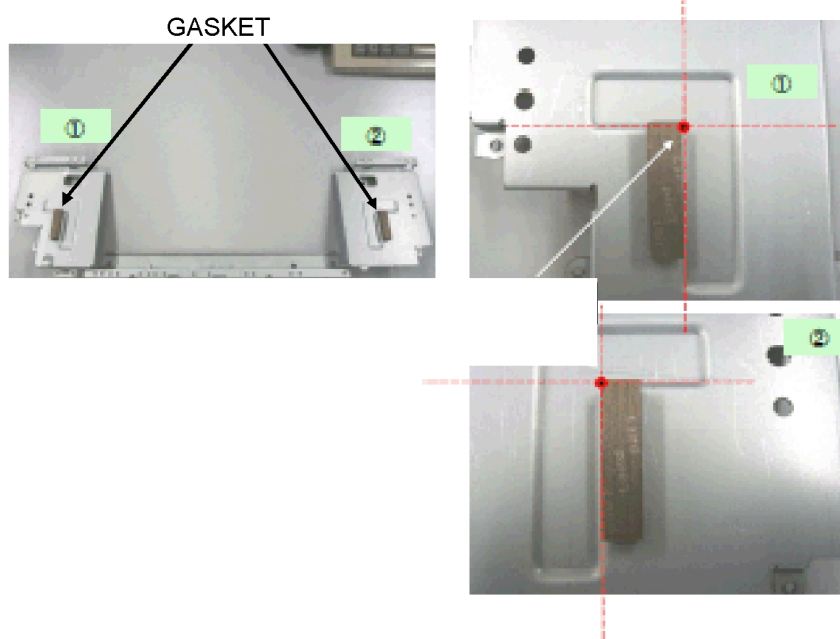

【Specification of attached Sponge】

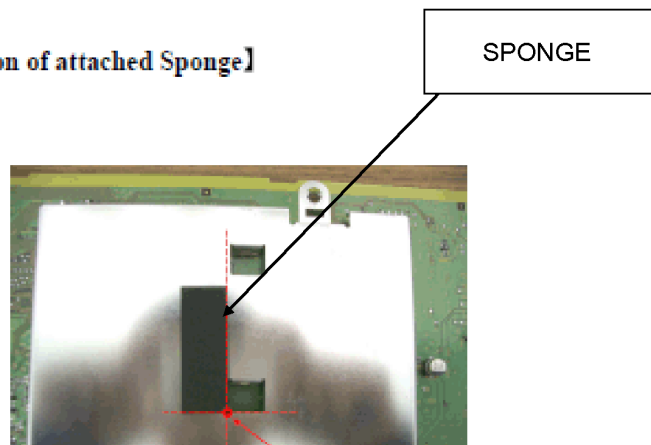

【Specification of attached Gasket】

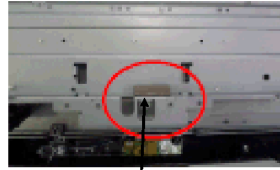

GASKET

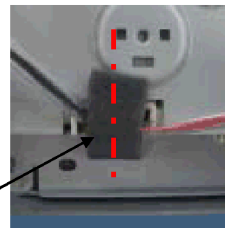
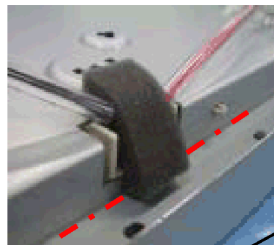
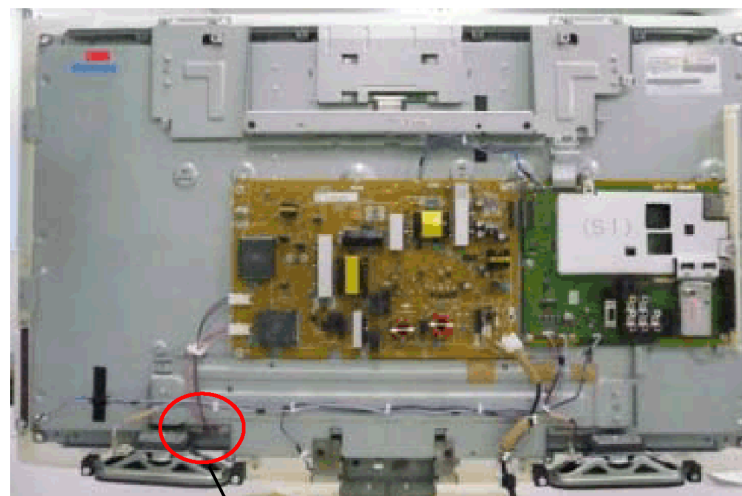
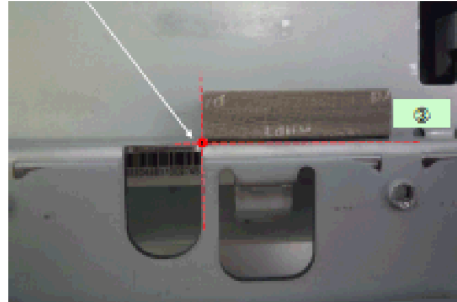

TMK2AG098
SPONGE
(15 X 35 X 10)

Reference:5mm from Cabinet Boss center

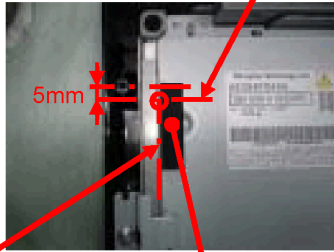

SPONGE:TMK2AG09601(t6 x 10 x 40)

Reference:Side face of LCD panel

BackSide Left-Upper

Reference:5mm from Cabinet Boss center

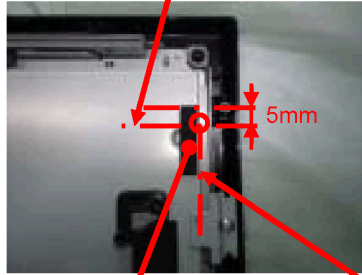

SPONGE:TMK2AG09601(t6 x 10 x 40)

Reference:Side face of LCD panel

BackSide Right-Upper

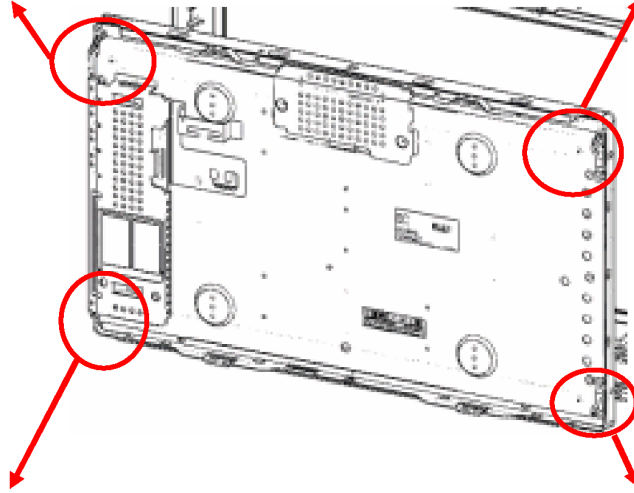

SPONGE:TMK2AG09601(t6 x 10 x 40)

Reference:side of LCD panel

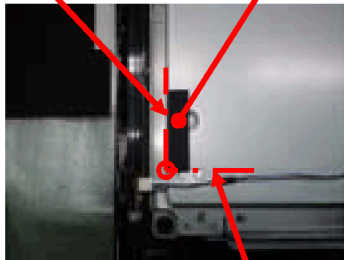

Reference:Lower side of white plastic circle

BackSide Left-Lower

SPONGE:TMK2AG09601(t6 x 10 x 40)

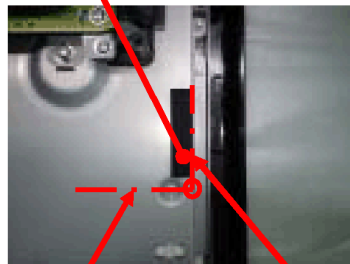

Reference:Side face of LCD panel

Reference:Center of LCD panel circle shape

BackSide Right-Lower

7.15. EMI processing (32 inch)

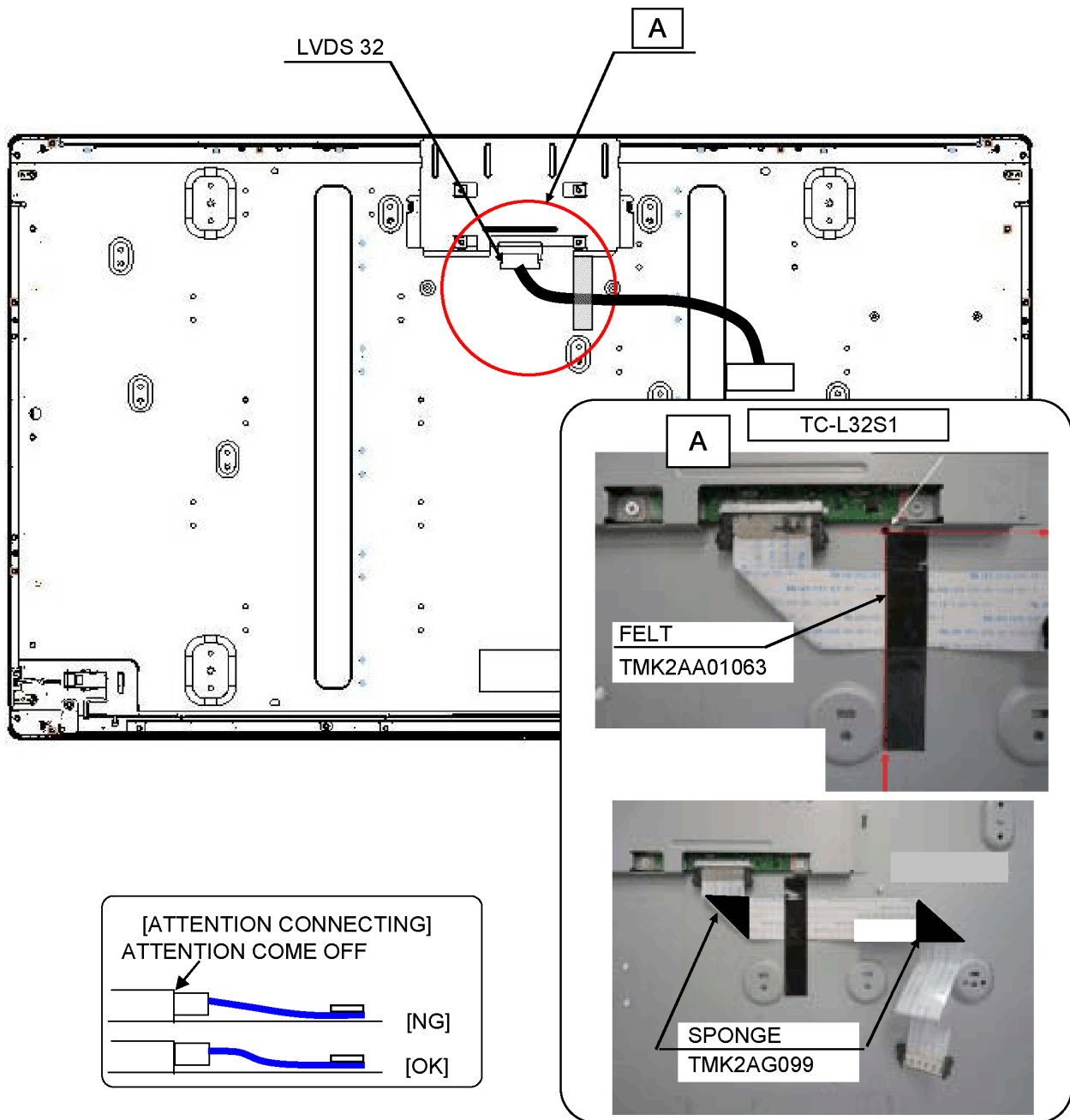

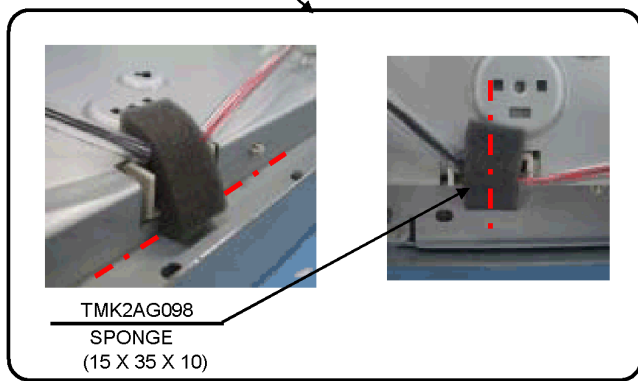
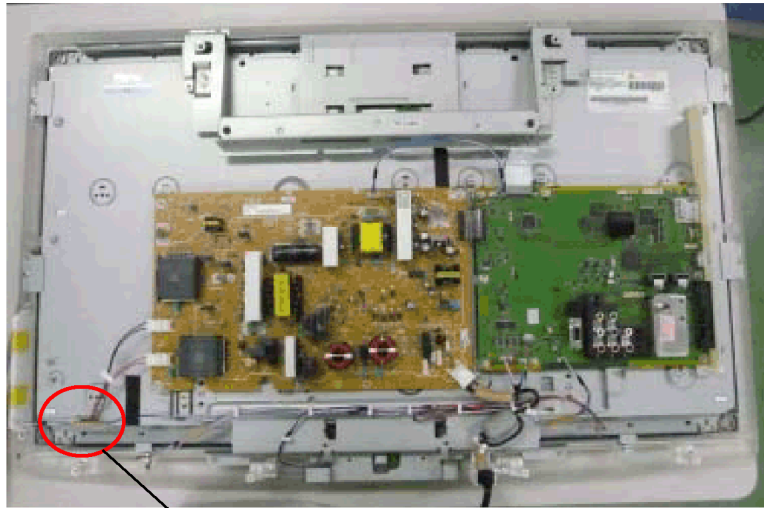
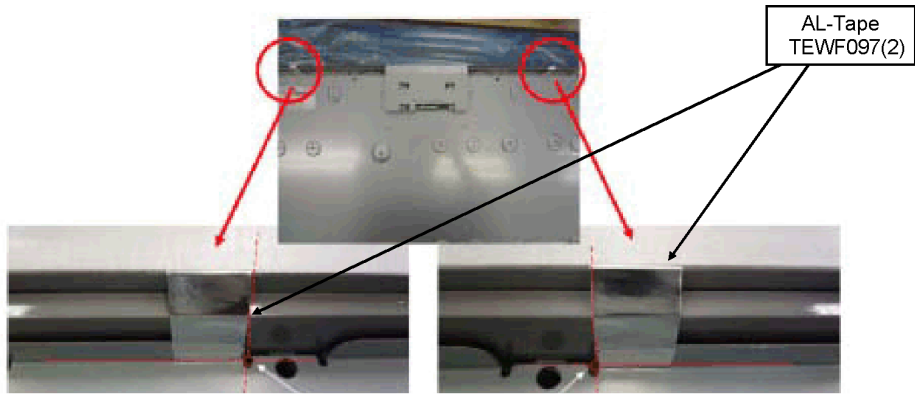

SPONGE
TMK2AG09601(t6 x 10 x 40)



SPONGE
TMK2AG09601(t6 x 10 x 40)

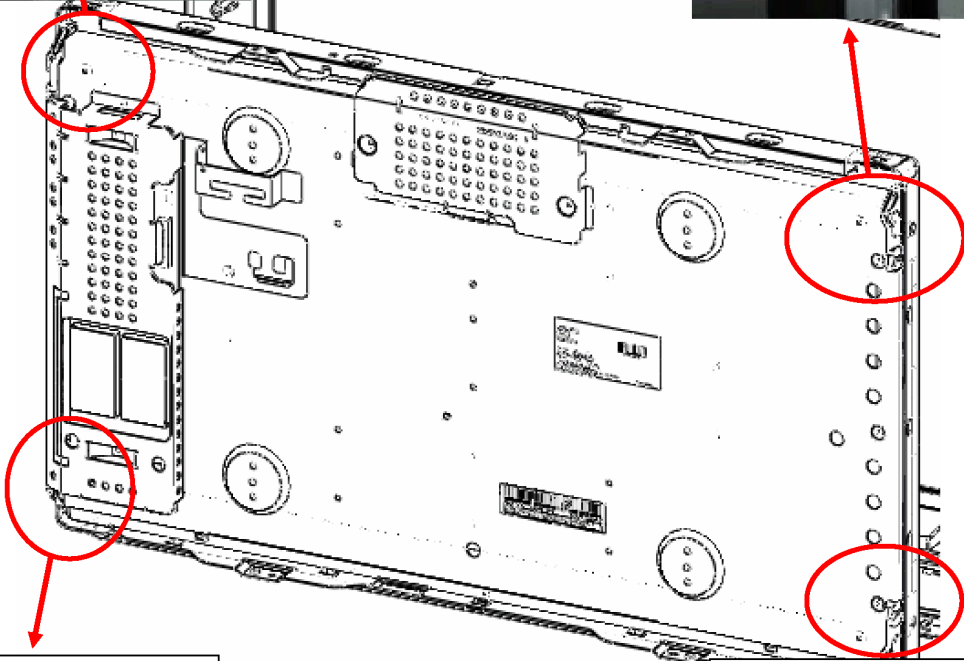

SPONGE
TMK2AG09701(t6 x 10 x 120)



SPONGE
TMK2AG09601(t6 x 10 x 40)

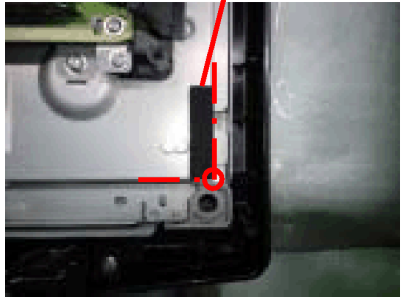

8 Measurements and Adjustments

8.1. Voltage chart of P-board

VOLTAGE	TEST POINT	SPECIFICATION (Reception state)
5.136	TP2831	5.2 ± 0.26 V
3.305	TP5480	3.3 ± 0.16 V
1.261	TP5602	1.26 ± 0.06 V
1.835	TP5601	1.83 ± 0.09 V
3.309	TP5600	3.3 ± 0.16 V
4.775	TP5405	5 ± 0.25 V
9.097	TP5481	9 ± 0.45 V
30.94	TP8300	30 ± 1.5 V
17.33	TP5431	17 ± 0.85 V
17.33	TP5417	17 ± 0.85 V
11.97	TP5432	12 ± 0.6 V
11.95	TP5413	12 ± 0.6 V
5.709	TP5433	5.6 ± 0.28 V
5.706	TP5439	5.6 ± 0.28 V

8.2. Voltage chart of A-board

VOLTAGE	TEST POINT	SPECIFICATION (Reception state)
STB5V	TP2831	5.2 ± 0.26 V
STB3.3V	TP5480	3.3 ± 0.16 V
SUB1.2V	TP5602	1.26 ± 0.06 V
SUB1.8V	TP5601	1.83 ± 0.09 V
SUB3.3V	TP5600	3.3 ± 0.16 V
SUB5V	TP5405	5 ± 0.25 V
SUB9V	TP5481	9 ± 0.45 V
BT30V	TP8300	30 ± 1.5 V
P17V	TP5431	17 ± 0.85 V
SOUNDVCC	TP5417	17 ± 0.85 V
DTV12V	TP5432	12 ± 0.6 V
PANEL12V	TP5413	12 ± 0.6 V
5VS	TP5433	5.6 ± 0.28 V
TUNER6V	TP5439	5.6 ± 0.28 V

8.3. Picture level adjustment (RF)

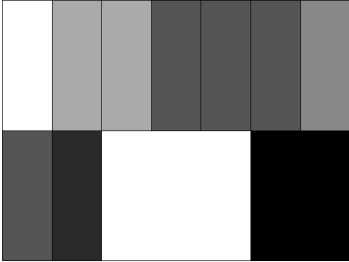
Instrument Name	Remarks
1. REMOTE TRANSMITTER 2. Ex. Signal (Split color bar)	
Adjustment or Inspection Procedure	Remarks
<p><procedure></p> <p>1. Receive the split color bar. (Screen mode: ZOOM or FULL Picture mode: DYNAMIC AI: OFF AI Picture: OFF) *BACK LIGHT +30</p> <p><Inspection></p> <p>1. Enter Service mode, and select MAIN_ADJ PICTURE. Volume UP/DOWN key makes GAIN displayed under PICTURE to set. Pushing the remote controller [OK] key for about 3 seconds, GAIN is suited to the adjustment value automatically.</p> <div style="text-align: center;">  <p>(The Split Color Bar Pattern)</p> </div>	

8.4. Picture level adjustment (VIDEO)

Instrument Name	Remarks
1. REMOTE TRANSMITTER 2. Video signal generator (100% Color bar)	
Adjustment or Inspection Procedure	Remarks
<p><procedure></p> <p>1. Receive 100% color bar. (ASPECT: ZOOM or FULL , Picture mode: VIVID , AI Picture: OFF) *BACK LIGHT MAX VALUE</p> <p><Inspection></p> <p>1. Enter Factory adjustment mode, and select ADJUST CONTRAST. Volume UP/DOWN key makes GAIN value displayed on the right of CONTRAST to set. Pushing the remote controller [OK] key for about 3 seconds, GAIN is suited to the adjustment value automatically.</p>	

8.5. Picture level adjustment (YUV)

Instrument Name	Remarks
1. REMOTE TRANSMITTER 2. Component Video signal generator (100% Color bar 1080i)	
Adjustment or Inspection Procedure	Remarks
<p><procedure></p> <p>1. Receive 100% color bar. (ASPECT: ZOOM or FULL , Picture mode: VIVID , AI Picture: OFF) *BACK LIGHT MAX VALUE</p> <p><Inspection></p> <p>1. Enter Factory adjustment mode, and select ADJUST CONTRAST. Volume UP/DOWN key makes GAIN value displayed on the right of CONTRAST to set. Pushing the remote controller [OK] key for about 3 seconds, GAIN is suited to the adjustment value automatically.</p>	

9 Block Diagram

9.1. Main Block Diagram

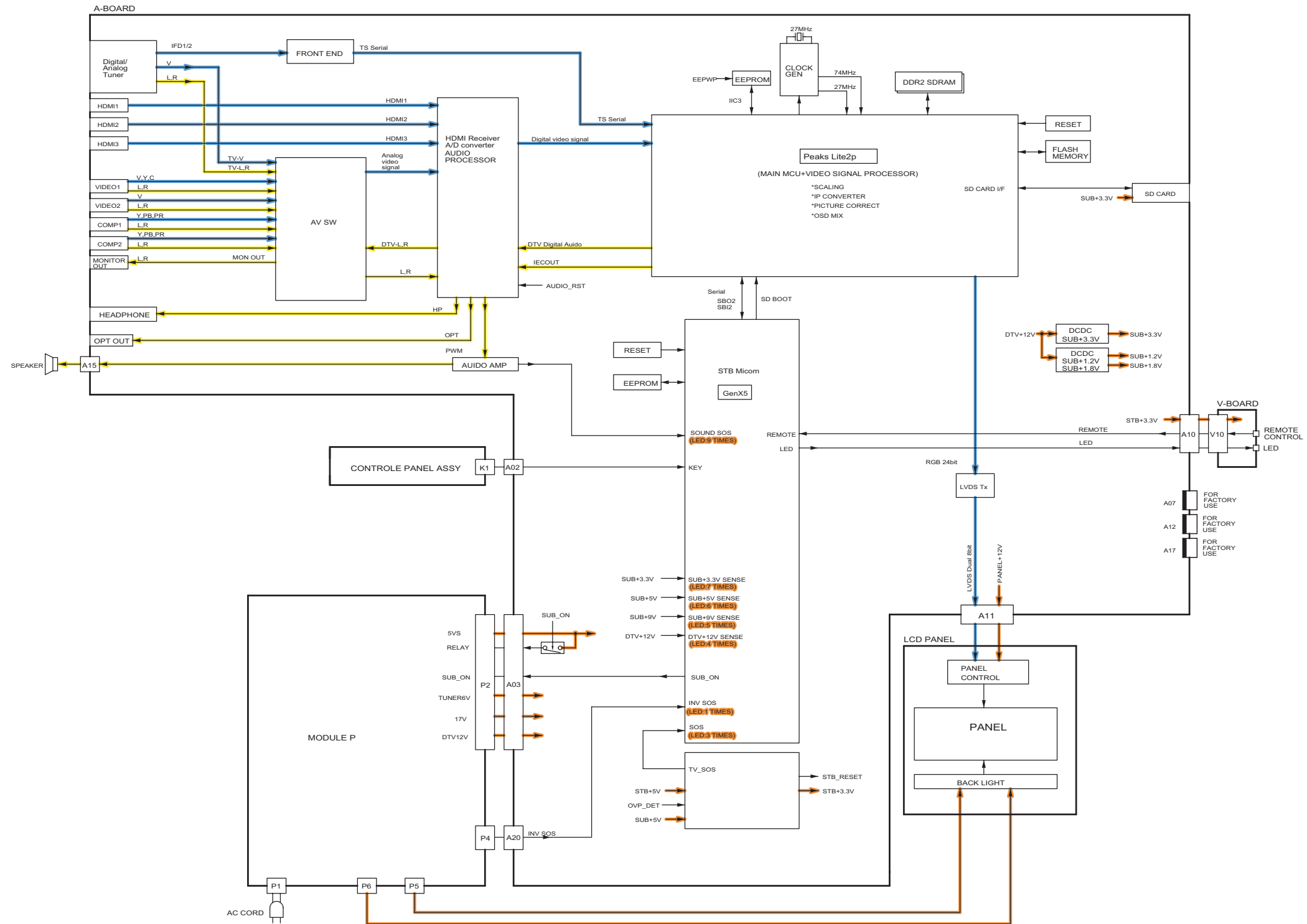

9.2. Block (1/2) Diagram

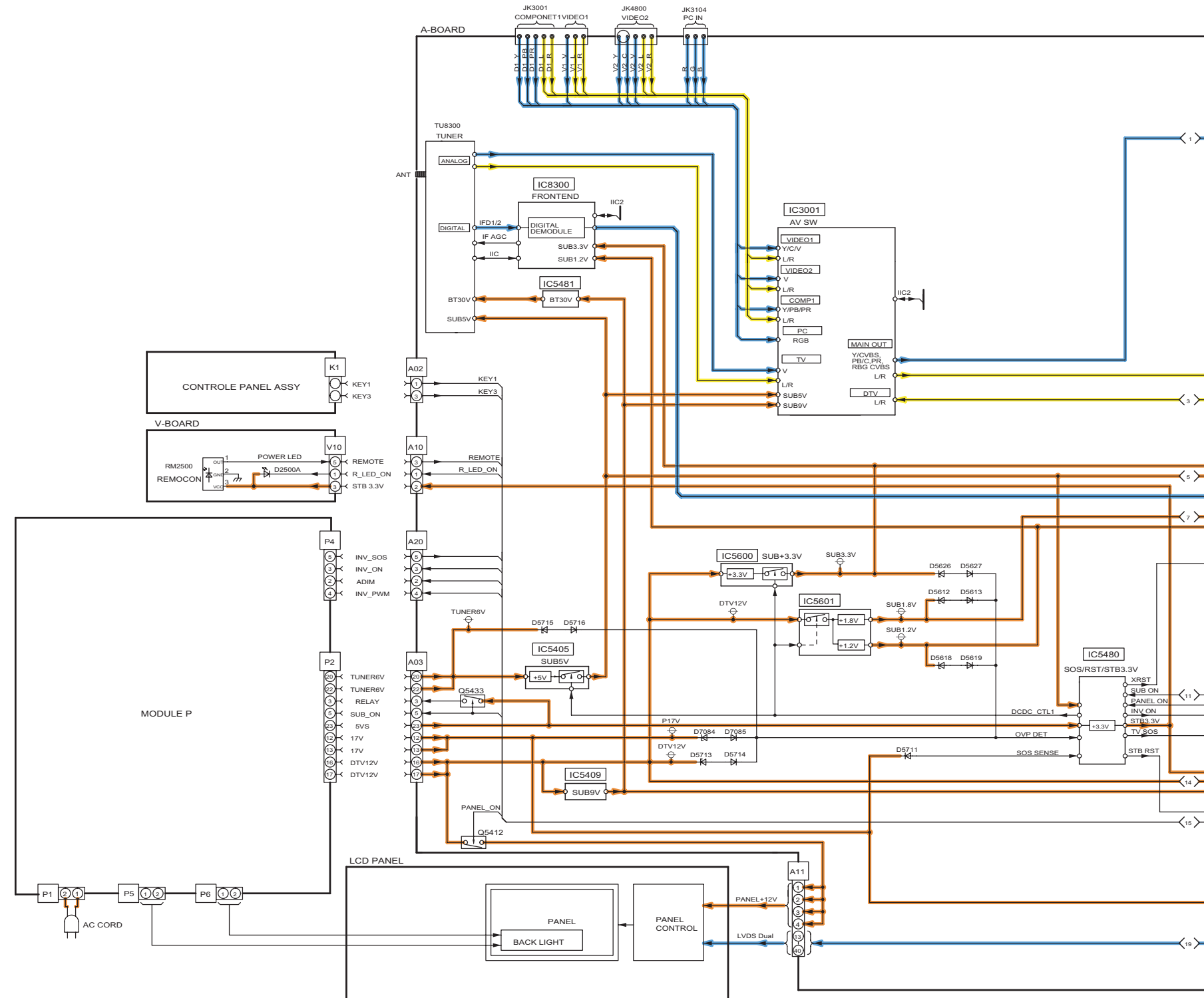

9.3. Block (2/2) Diagram

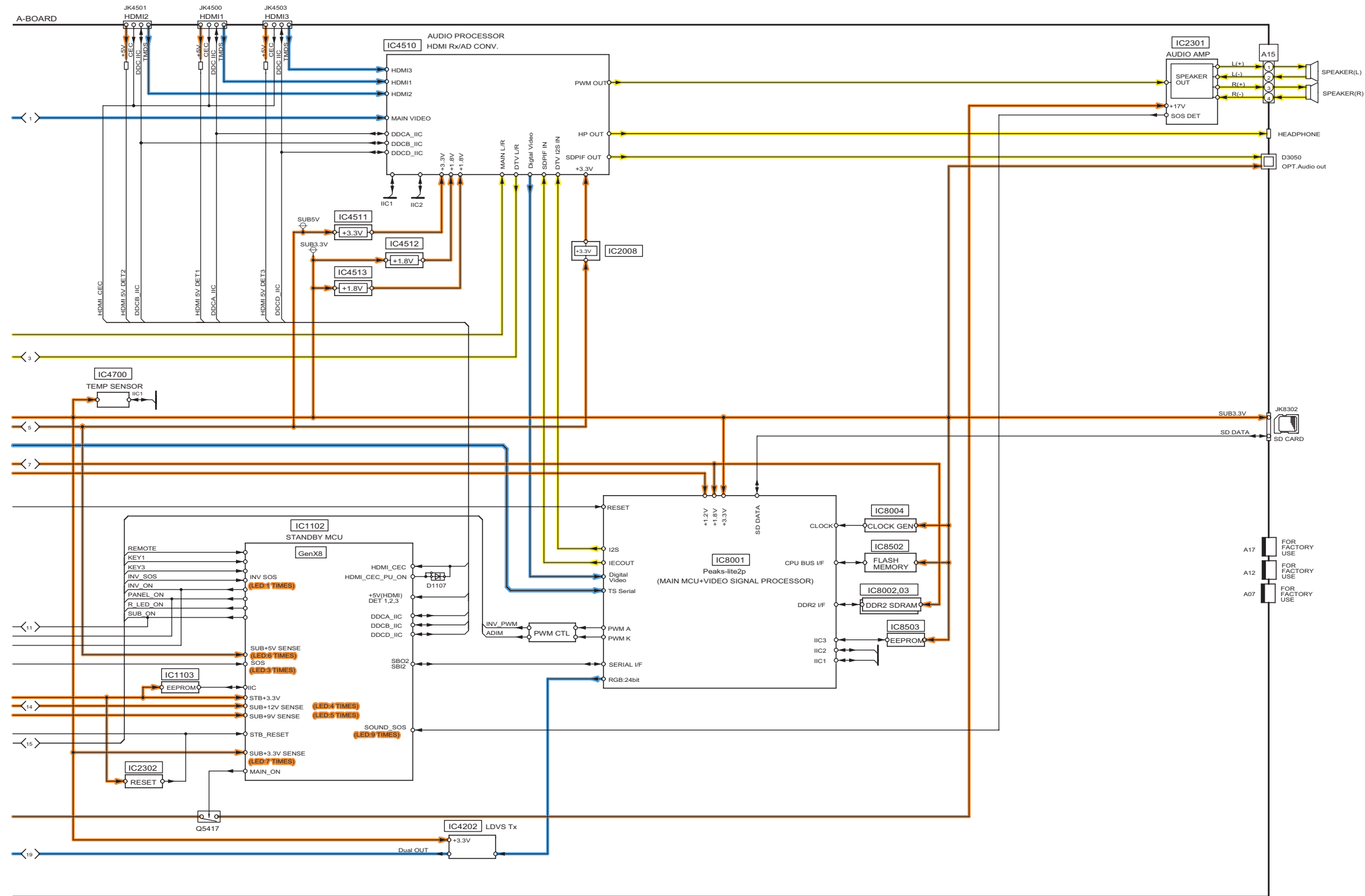

10 Wiring Connection Diagram

10.1. Caution statement.

Caution:
 Please confirm that all flexible cables are assembled correctly.
 Also make sure that they are locked in the connectors.
 Verify by giving the flexible cables a very slight pull.

10.2. Wiring (32 inch)

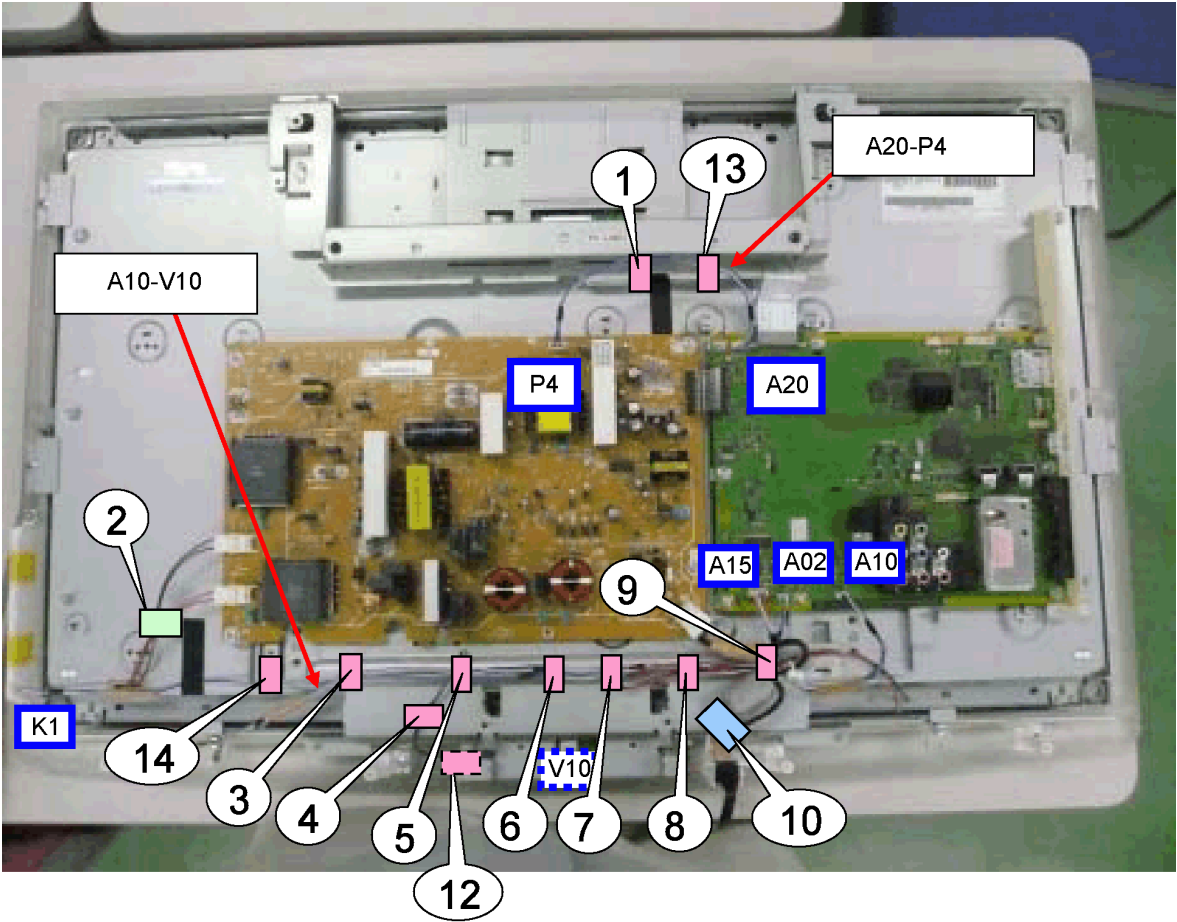

- TMME268 (11) ①③④⑤⑥⑦⑧⑨⑫⑬⑭
- TMME047 ⑩
- TMME340 ②

	①	②	③	④	⑤	⑥	⑦	⑧	⑨	⑩	⑪	⑫	⑬	⑭
A02-K1			●		●	●	●	●	●					●
A10-V10				●	●	●	●	●	●			●		
A15-SP			●		●	●	●	●	●					●
A20-P4	●												●	
AC cord-P1										●				

10.3. Wiring (37 inch)

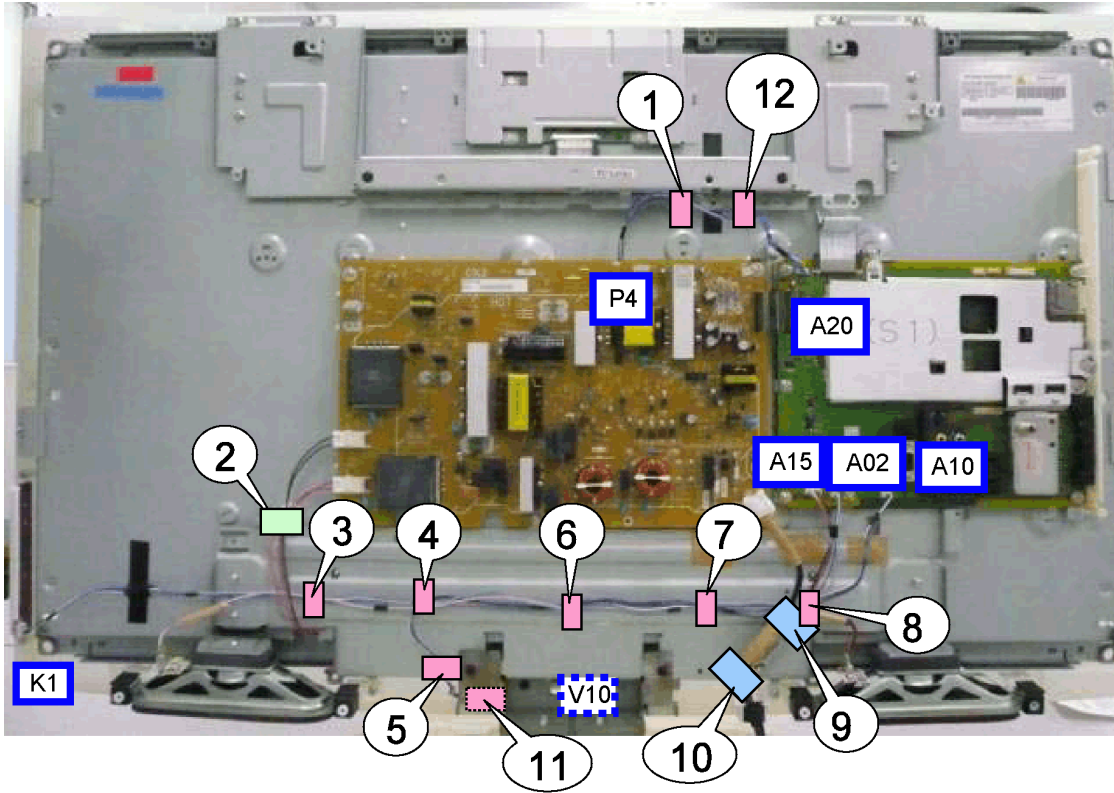







- TMME268 (9)①③④⑤⑥⑦⑧⑪⑫
- TMME357 (2)⑨⑩
- TMME340 (1)②

	①	②	③	④	⑤	⑥	⑦	⑧	⑨	⑩	⑪	⑫	⑬	⑭
A02-K1			●	●		●	●	●						
A10-V10				●	●	●	●	●			●			
A15-SP			●	●		●	●	●						
A20-P4	●													
AC cord-P1									●	●				

11 Schematic Diagram

11.1. Schematic Diagram Notes

Notes:

- Resistor**
Unit of resistance is OHM [Ω] (K=1,000, M=1,000,000).
- Capacitor**
Unit of capacitance is μ F, unless otherwise noted.
- Coil**
Unit of inductance is H, unless otherwise noted.
- Test Point**
 : Test Point position
- Earth Symbol**
 : Chassis Earth (Cold)  : Line Earth (Hot)
- Voltage Measurement**
Voltage is measured by a DC voltmeter.
Conditions of the measurement are the following:
Power Source AC110-127V, 60Hz
Receiving Signal Colour Bar signal (RF)
All customer's controls Maximum positions
- When arrow mark () is found, connection is easily found from the direction of arrow.
- Indicates the major signal flow. : Video  Audio 
- This schematic diagram is the latest at the time of printing and subject to change without notice.

Remarks:

- The Power Circuit contains a circuit area which uses a separate power supply to isolate the earth connection.
The circuit is defined by HOT and COLD indications in the schematic diagram. Take the following precautions.
All circuits, except the Power Circuit, are cold.
Precautions
 - Do not touch the hot part or the hot and cold parts at the same time or you may be shocked.
 - Do not short-circuit the hot and cold circuits or a fuse may blow and parts may break.
 - Do not connect an instrument, such as an oscilloscope, to the hot and cold circuits simultaneously or a fuse may blow.
Connect the earth of instruments to the earth connection of the circuit being measured.
 - Make sure to disconnect the power plug before removing the chassis.

11.2. A-Board (1/11) Schematic Diagram

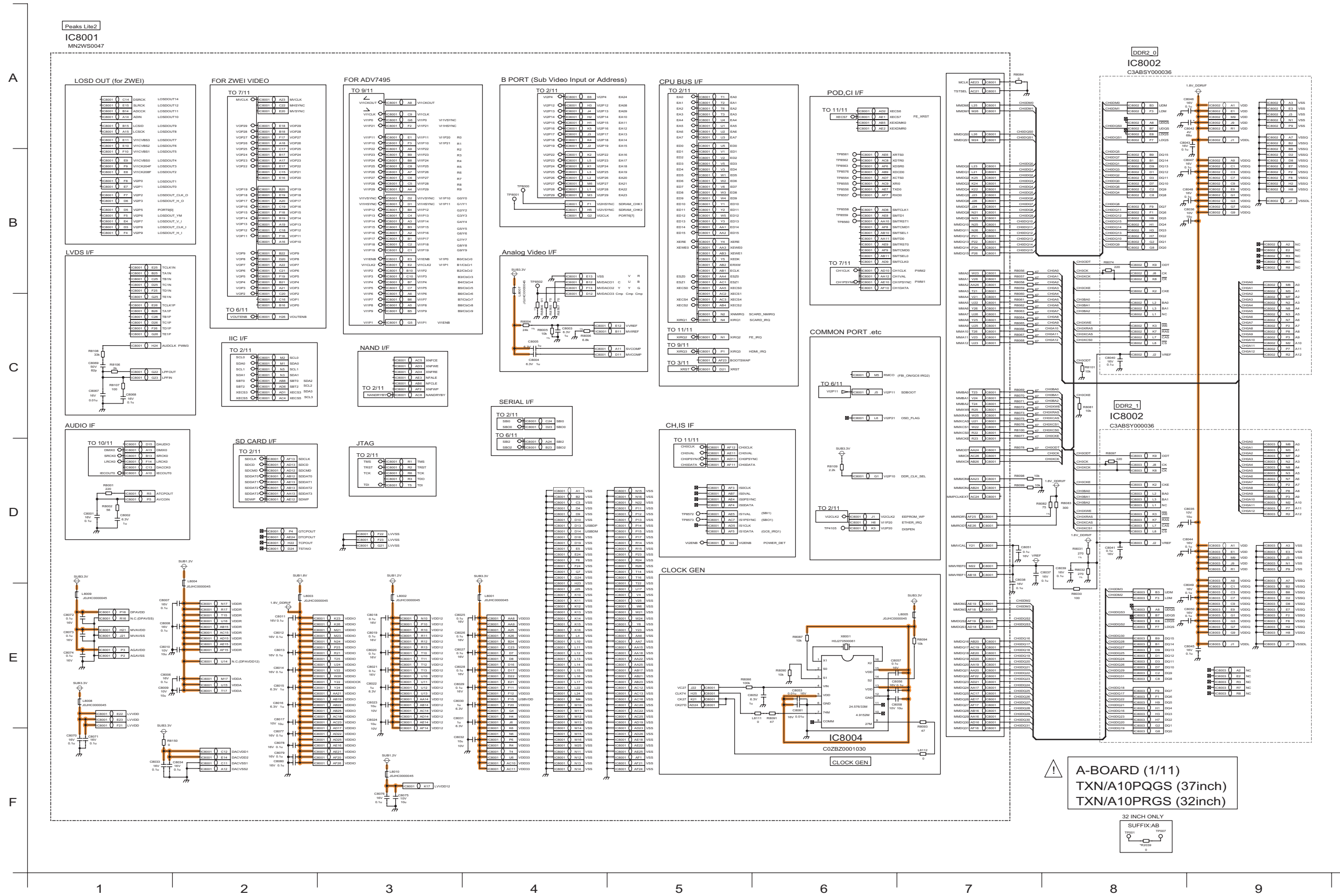

11.3. A-Board (2/11) Schematic Diagram

⚠ A-BOARD (2/11)
TXN/A10PQGS (37inch)
TXN/A10PRGS (32inch)

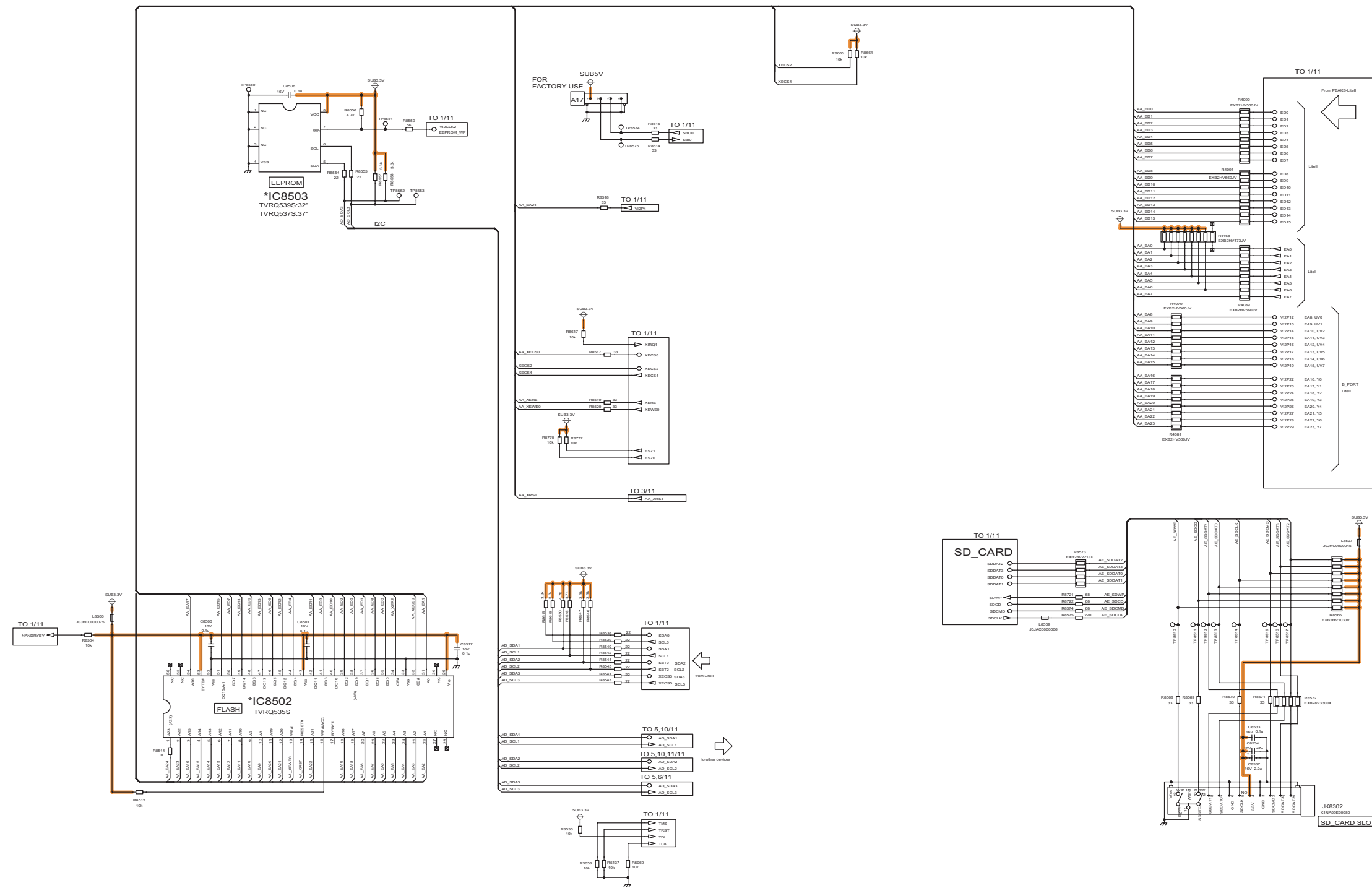

10 11 12 13 14 15 16 17 18

11.4. A-Board (3/11) Schematic Diagram

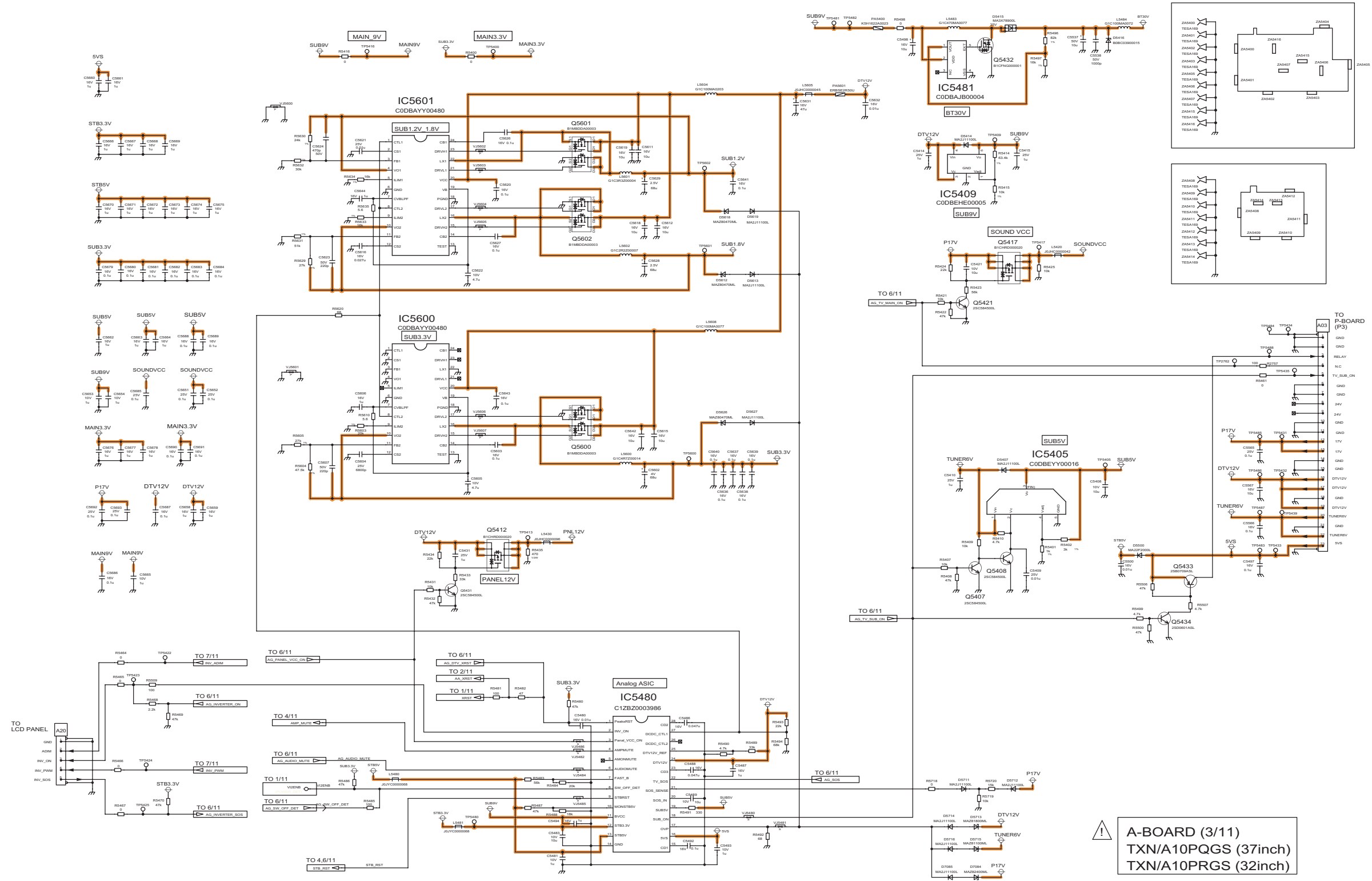

19

20

21

22

23

24

25

26

27

11.5. A-Board (4/11) Schematic Diagram

! A-BOARD (4/11)
TXN/A10PQGS (37inch)
TXN/A10PRGS (32inch)

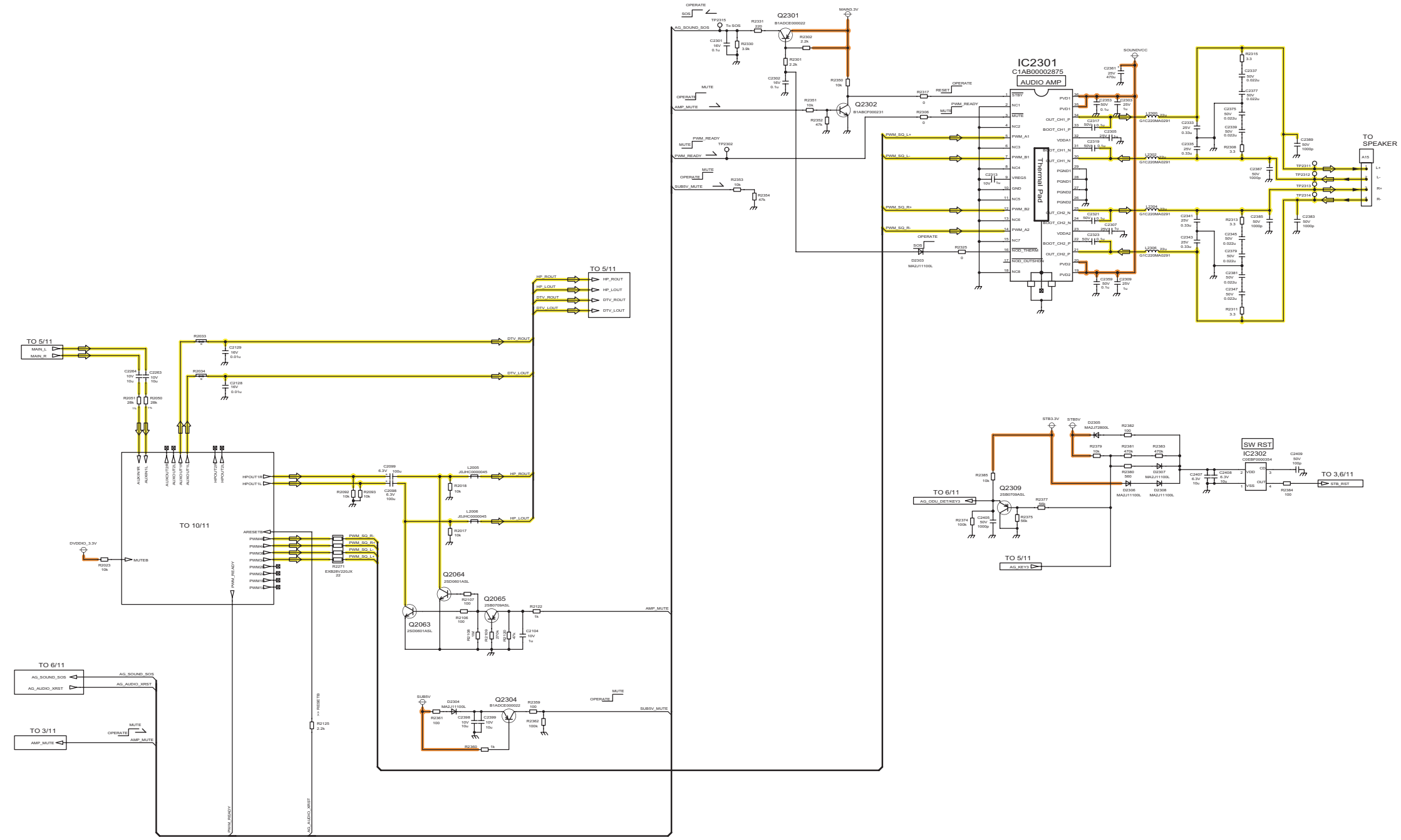

28 29 30 31 32 33 34 35 36

11.6. A-Board (5/11) Schematic Diagram

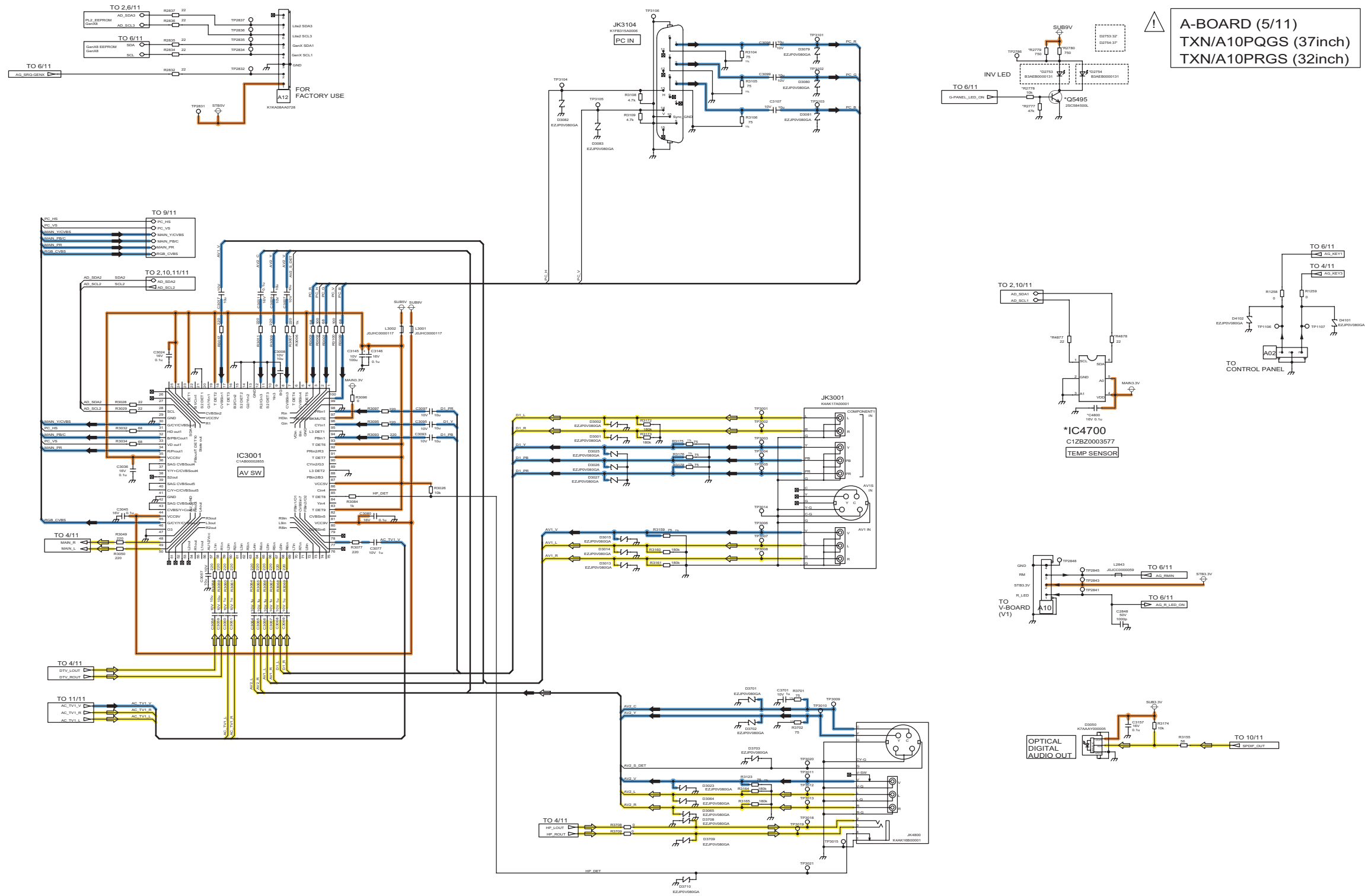

37 38 39 40 41 42 43 44 45

11.7. A-Board (6/11) Schematic Diagram

! A-BOARD (6/11)
TXN/A10PQGS (37inch)
TXN/A10PRGS (32inch)

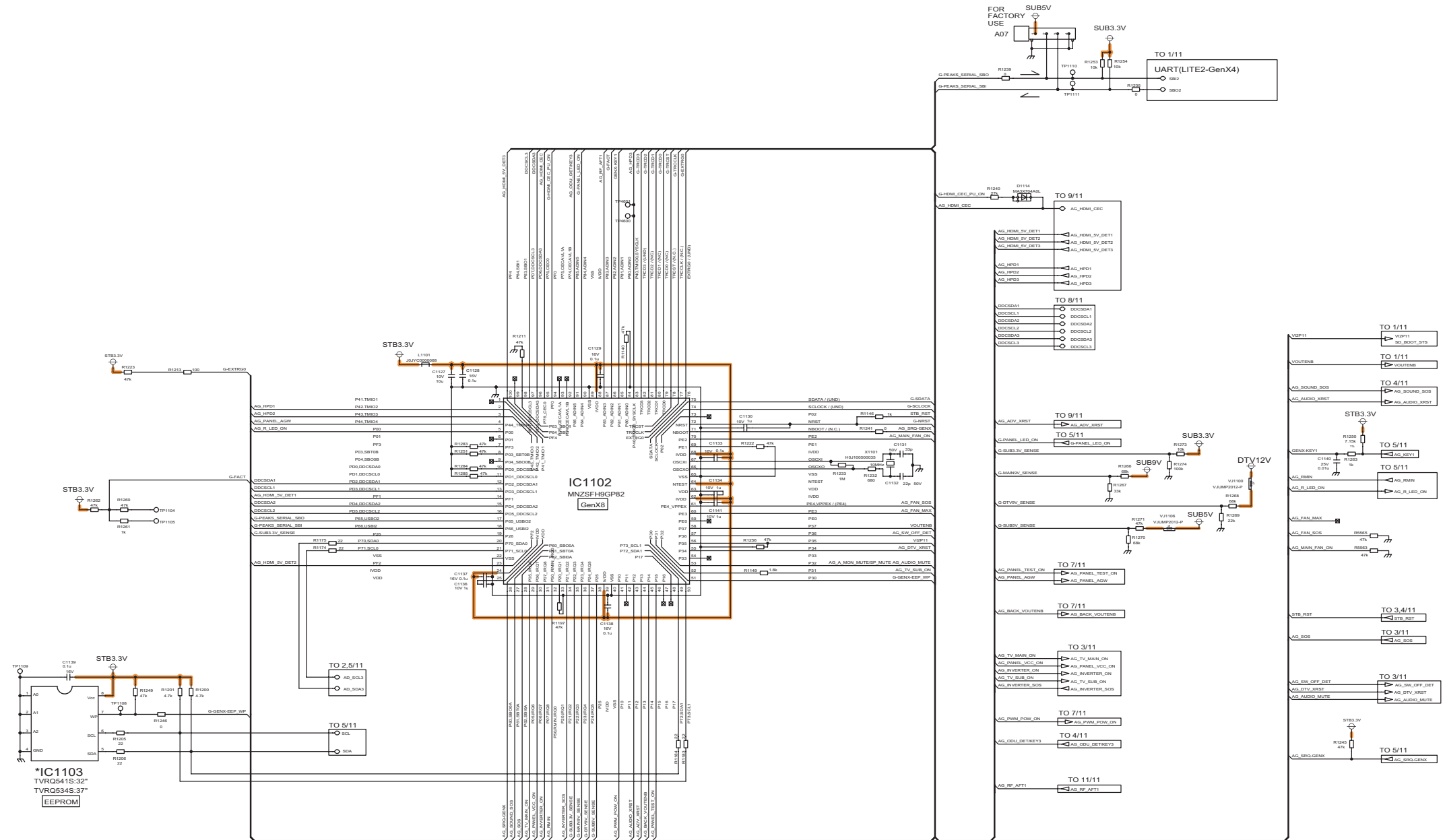

11.8. A-Board (7/11) Schematic Diagram

A-BOARD (7/11)
 TXN/A10PQGS (37inch)
 TXN/A10PRGS (32inch)

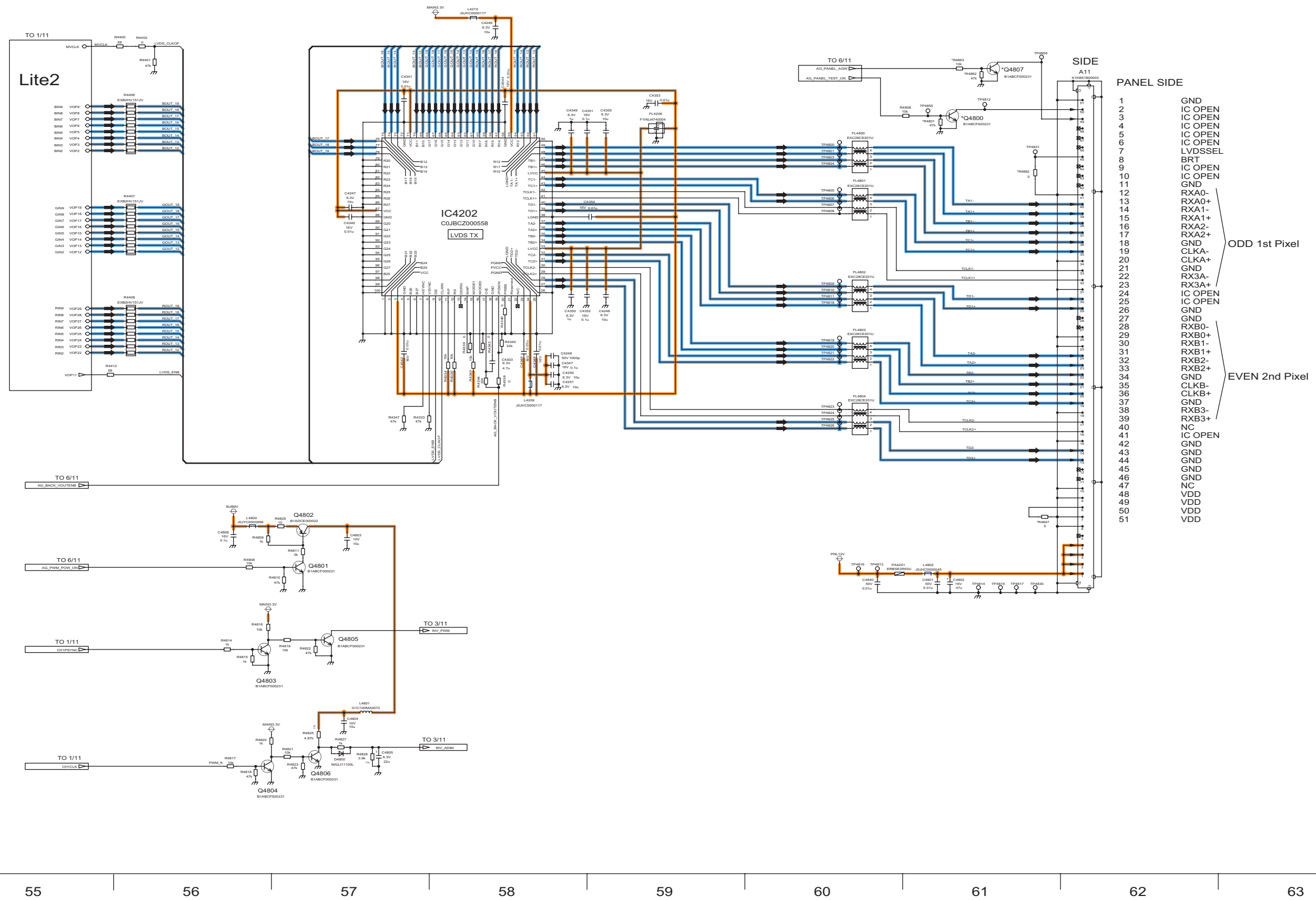

11.9. A-Board (8/11) Schematic Diagram

! A-BOARD (8/11)
 TXN/A10PQGS (37inch)
 TXN/A10PRGS (32inch)

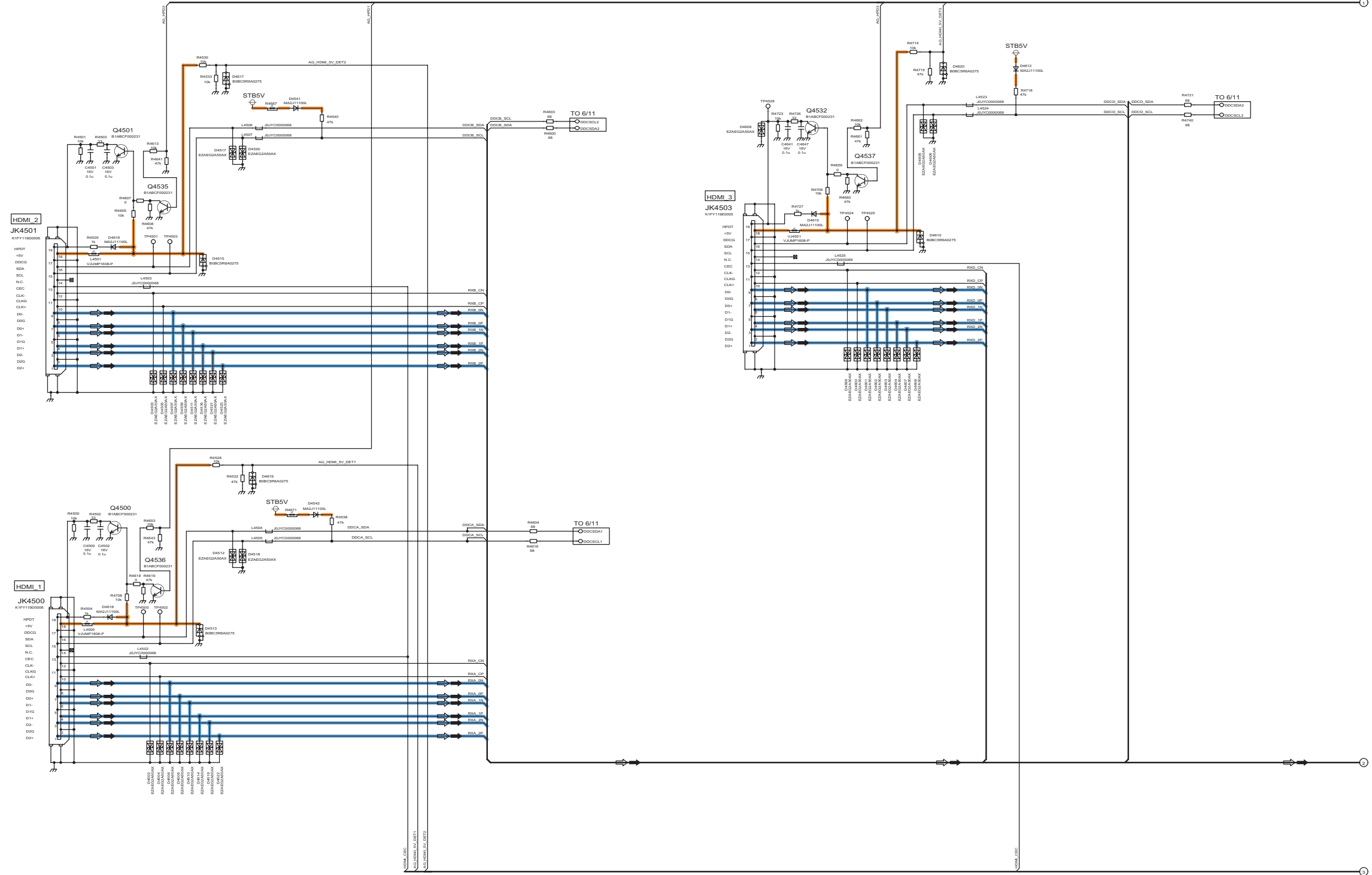

64

65

66

67

68

69

70

71

72

11.10. A-Board (9/11) Schematic Diagram

! A-BOARD (9/11)
 TXN/A10PQGS (37inch)
 TXN/A10PRGS (32inch)

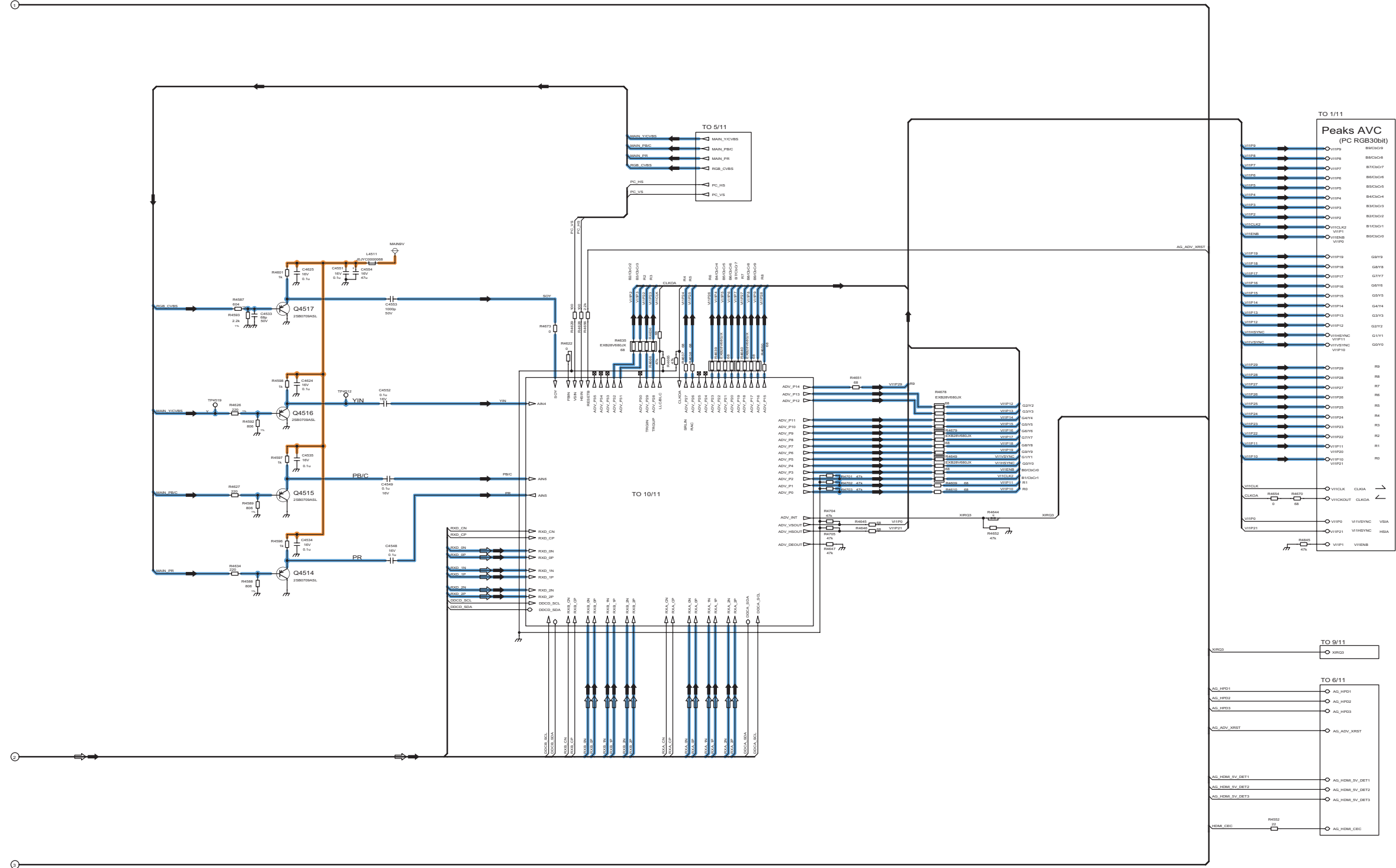

73 74 75 76 77 78 79 80 81

11.11. A-Board (10/11) Schematic Diagram

A-BOARD (10/11)
TXN/A10PQGS (37inch)
TXN/A10PRGS (32inch)

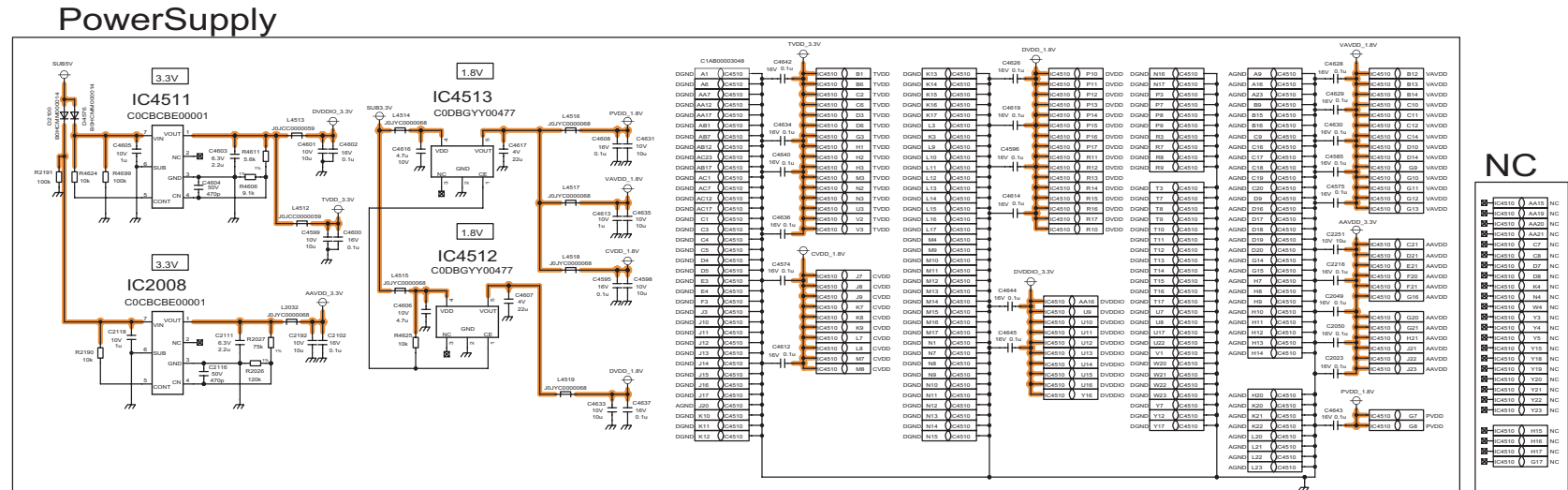

Pin	Signal	Value
C4510	B12	UVDD0
C4510	B13	UVDD0
C4510	B14	UVDD0
C4510	B15	UVDD0
C4510	B16	UVDD0
C4510	B17	UVDD0
C4510	B18	UVDD0
C4510	B19	UVDD0
C4510	B20	UVDD0
C4510	B21	UVDD0
C4510	B22	UVDD0
C4510	B23	UVDD0
C4510	B24	UVDD0
C4510	B25	UVDD0
C4510	B26	UVDD0
C4510	B27	UVDD0
C4510	B28	UVDD0
C4510	B29	UVDD0
C4510	B30	UVDD0
C4510	B31	UVDD0
C4510	B32	UVDD0
C4510	B33	UVDD0
C4510	B34	UVDD0
C4510	B35	UVDD0
C4510	B36	UVDD0
C4510	B37	UVDD0
C4510	B38	UVDD0
C4510	B39	UVDD0
C4510	B40	UVDD0
C4510	B41	UVDD0
C4510	B42	UVDD0
C4510	B43	UVDD0
C4510	B44	UVDD0
C4510	B45	UVDD0
C4510	B46	UVDD0
C4510	B47	UVDD0
C4510	B48	UVDD0
C4510	B49	UVDD0
C4510	B50	UVDD0
C4510	B51	UVDD0
C4510	B52	UVDD0
C4510	B53	UVDD0
C4510	B54	UVDD0
C4510	B55	UVDD0
C4510	B56	UVDD0
C4510	B57	UVDD0
C4510	B58	UVDD0
C4510	B59	UVDD0
C4510	B60	UVDD0
C4510	B61	UVDD0
C4510	B62	UVDD0
C4510	B63	UVDD0
C4510	B64	UVDD0
C4510	B65	UVDD0
C4510	B66	UVDD0
C4510	B67	UVDD0
C4510	B68	UVDD0
C4510	B69	UVDD0
C4510	B70	UVDD0
C4510	B71	UVDD0
C4510	B72	UVDD0
C4510	B73	UVDD0
C4510	B74	UVDD0
C4510	B75	UVDD0
C4510	B76	UVDD0
C4510	B77	UVDD0
C4510	B78	UVDD0
C4510	B79	UVDD0
C4510	B80	UVDD0
C4510	B81	UVDD0
C4510	B82	UVDD0
C4510	B83	UVDD0
C4510	B84	UVDD0
C4510	B85	UVDD0
C4510	B86	UVDD0
C4510	B87	UVDD0
C4510	B88	UVDD0
C4510	B89	UVDD0
C4510	B90	UVDD0
C4510	B91	UVDD0
C4510	B92	UVDD0
C4510	B93	UVDD0
C4510	B94	UVDD0
C4510	B95	UVDD0
C4510	B96	UVDD0
C4510	B97	UVDD0
C4510	B98	UVDD0
C4510	B99	UVDD0
C4510	B100	UVDD0

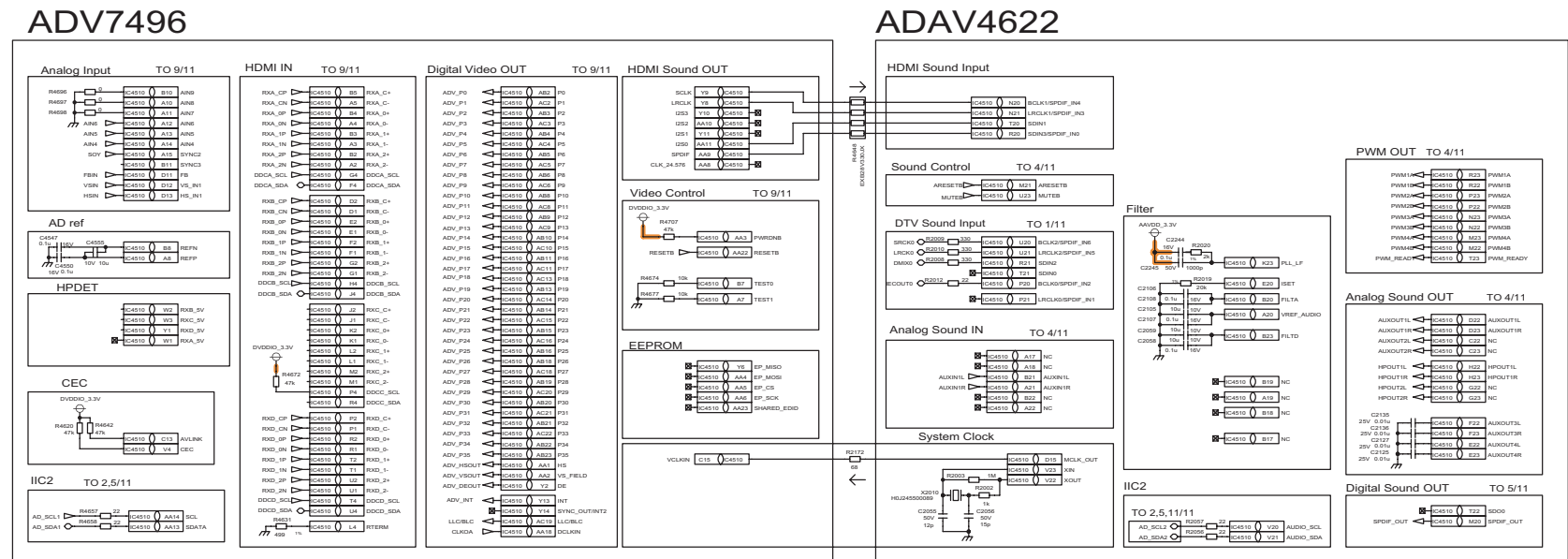

11.12. A-Board (11/11) Schematic Diagram

⚠ A-BOARD (11/11)
TXN/A10PQGS (37inch)
TXN/A10PRGS (32inch)

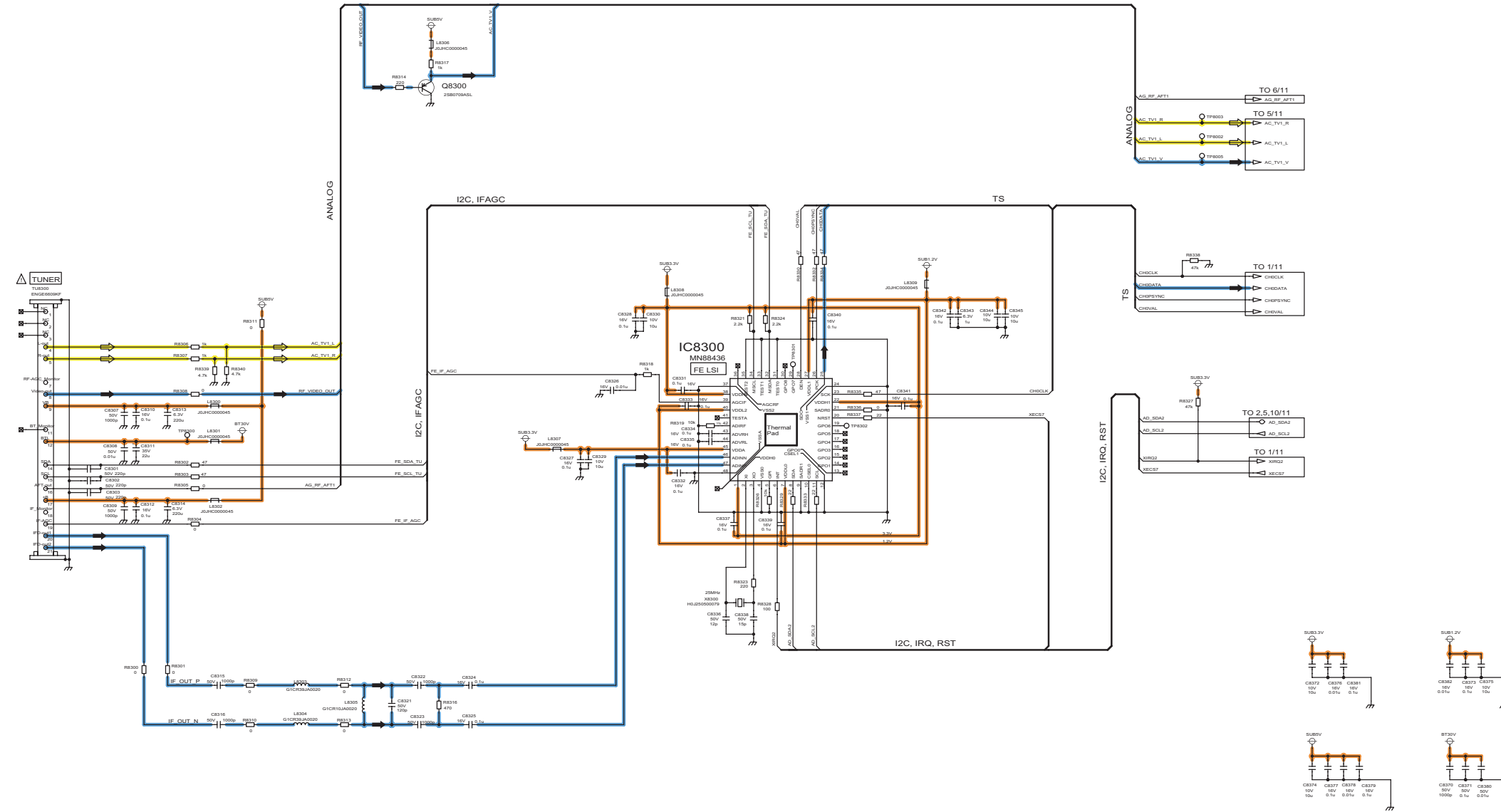

91

92

93

94

95

96

97

98

99

11.13. V-Board Schematic Diagram

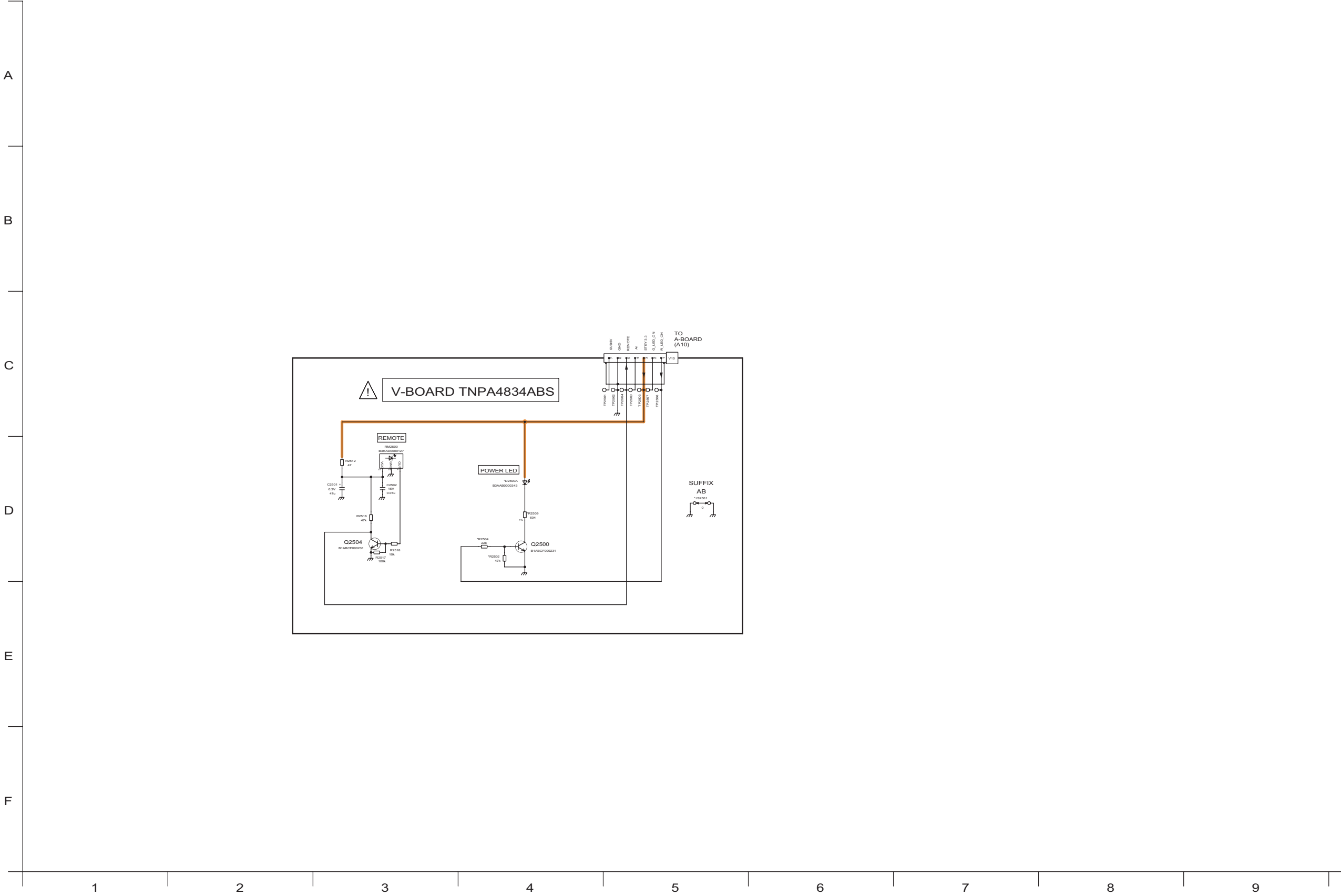

12 Printed Circuit Board

12.1. A-Board

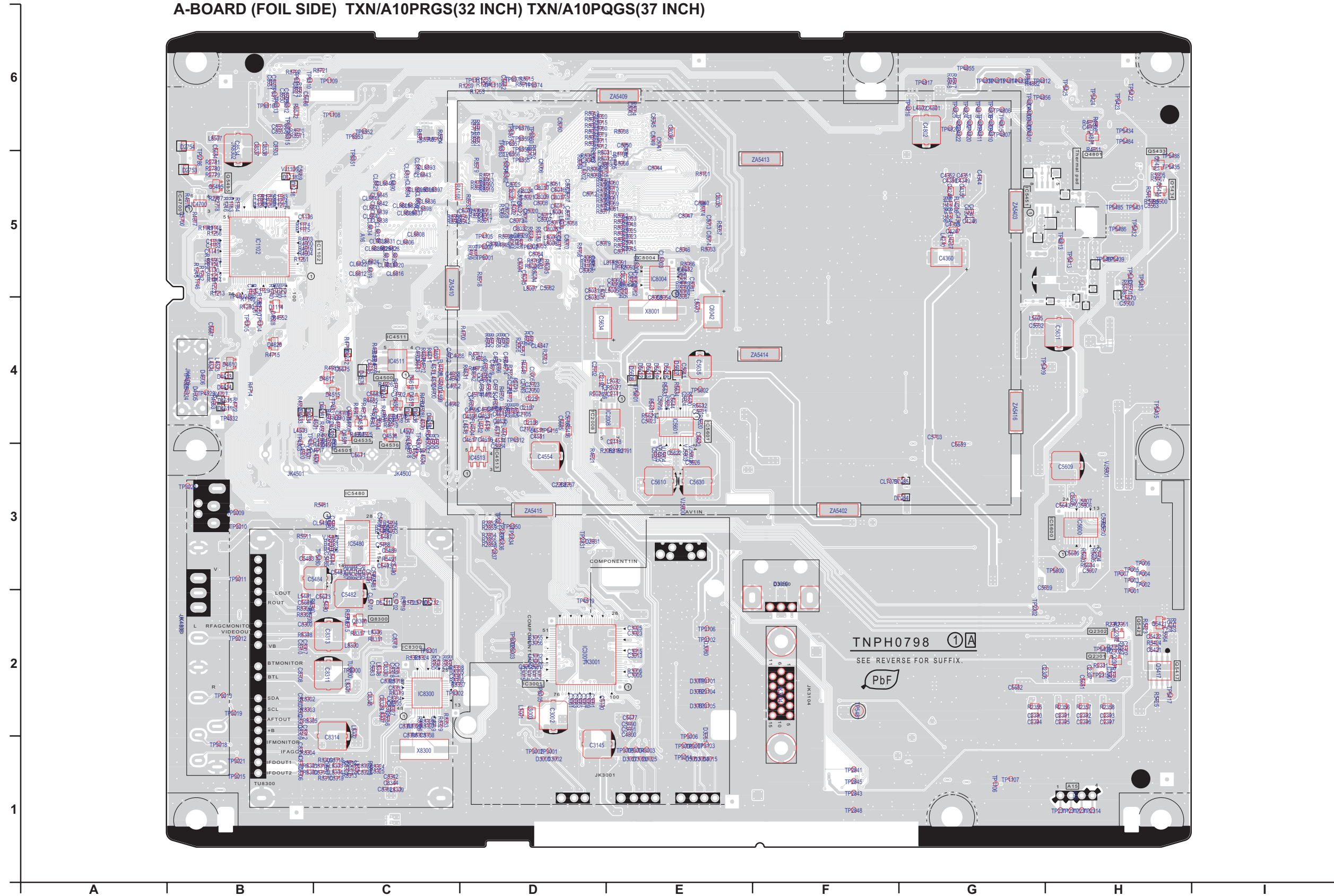

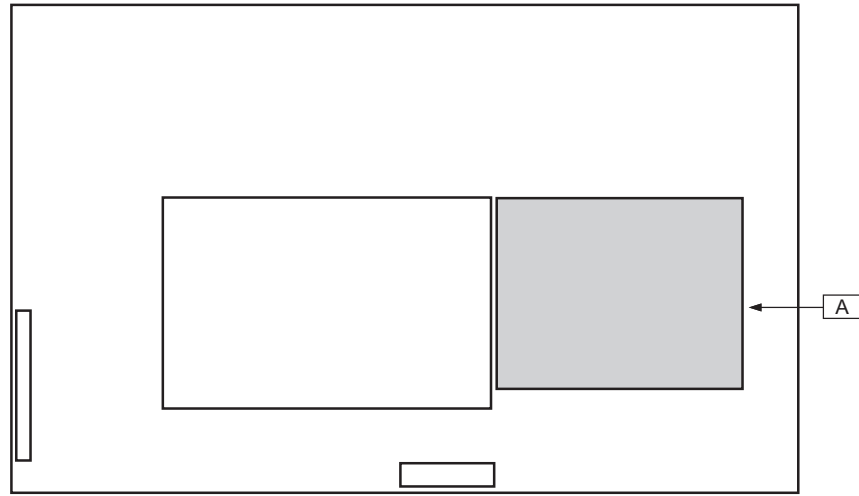

Parts Location

A-BOARD (FOIL SIDE)			
IC	TRANSISTOR		
IC1102	B-5	Q2301	H-2
IC2008	E-4	Q2302	H-2
IC3001	D-2	Q4500	C-4
IC4511	C-4	Q4501	C-3
IC4513	D-3	Q4535	C-4
IC4700	B-5	Q4536	C-4
IC5451	H-5	Q4801	H-5
IC5480	C-3	Q5417	H-2
IC5600	H-3	Q5421	H-2
IC5601	E-4	Q5433	H-5
IC8004	E-5	Q5434	H-5
IC8300	C-2	Q5495	B-5
		Q8300	C-2

Parts Location

A-BOARD (COMPONENT SIDE)			
IC	TRANSISTOR		
IC1103	H-6	Q2063	F-3
IC2301	C-2	Q2064	E-3
IC2302	C-1	Q2065	E-3
IC4202	C-5	Q2303	B-2
IC4510	G-4	Q2304	B-2
IC4512	E-4	Q2309	C-1
IC5405	B-4	Q4514	F-3
IC5409	B-4	Q4515	F-3
IC5481	D-1	Q4516	F-4
IC8001	F-6	Q4517	F-3
IC8002	E-5	Q4532	H-4
IC8003	E-5	Q4537	H-4
IC8502	G-6	Q4800	B-6
IC8503	G-6	Q4802	B-5
		Q4803	B-6
		Q4804	B-5
		Q4805	B-6
		Q4806	B-6
		Q4807	B-6
		Q5407	B-4
		Q5408	B-4
		Q5412	B-5
		Q5431	B-4
		Q5432	D-2
		Q5451	B-5
		Q5452	B-5
		Q5471	B-4
		Q5600	B-3
		Q5601	E-3
		Q5602	E-3

A-BOARD (COMPONENT SIDE) TXN/A10PRGS(32 INCH) TXN/A10PQGS(37 INCH)

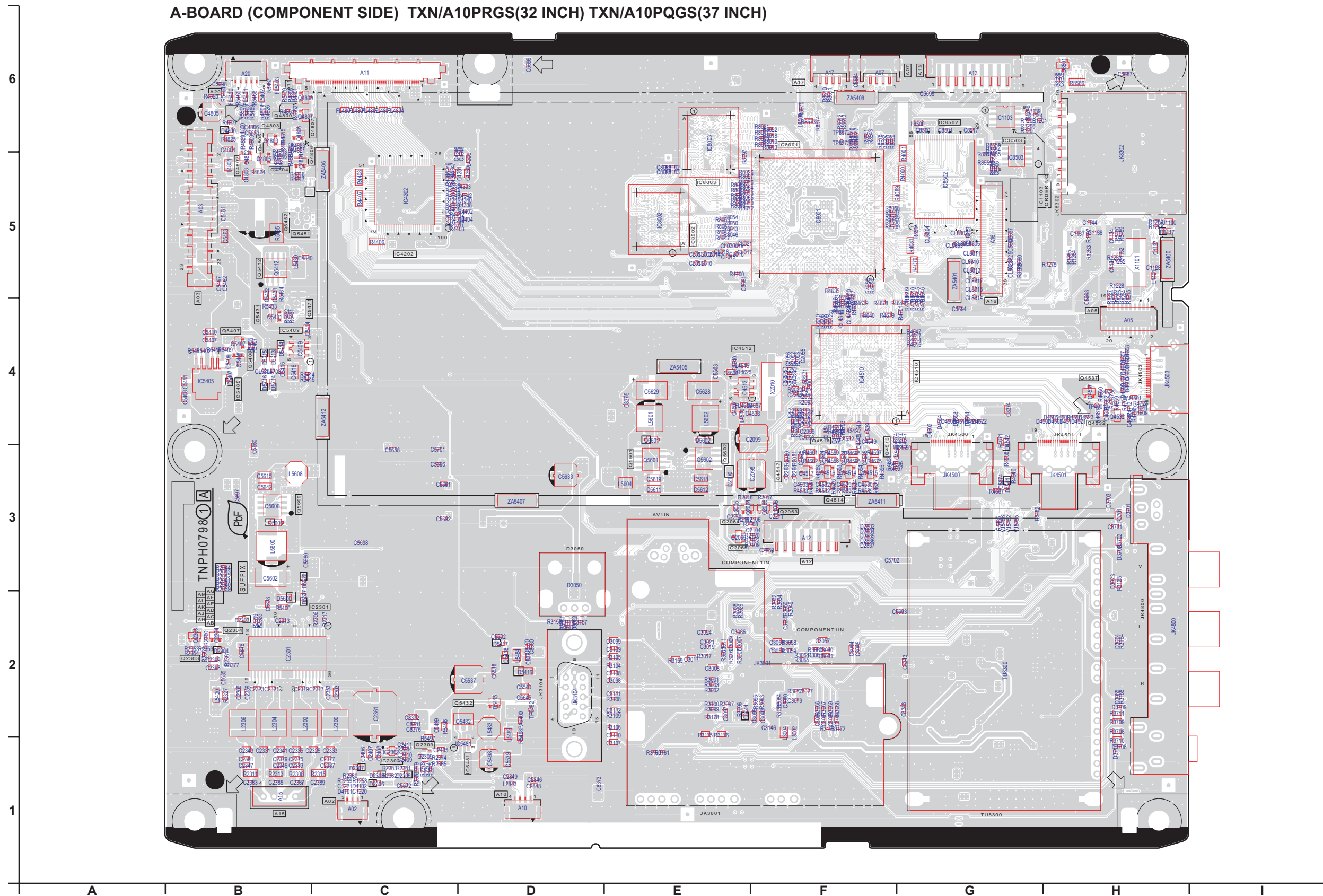

12.2. V-Board

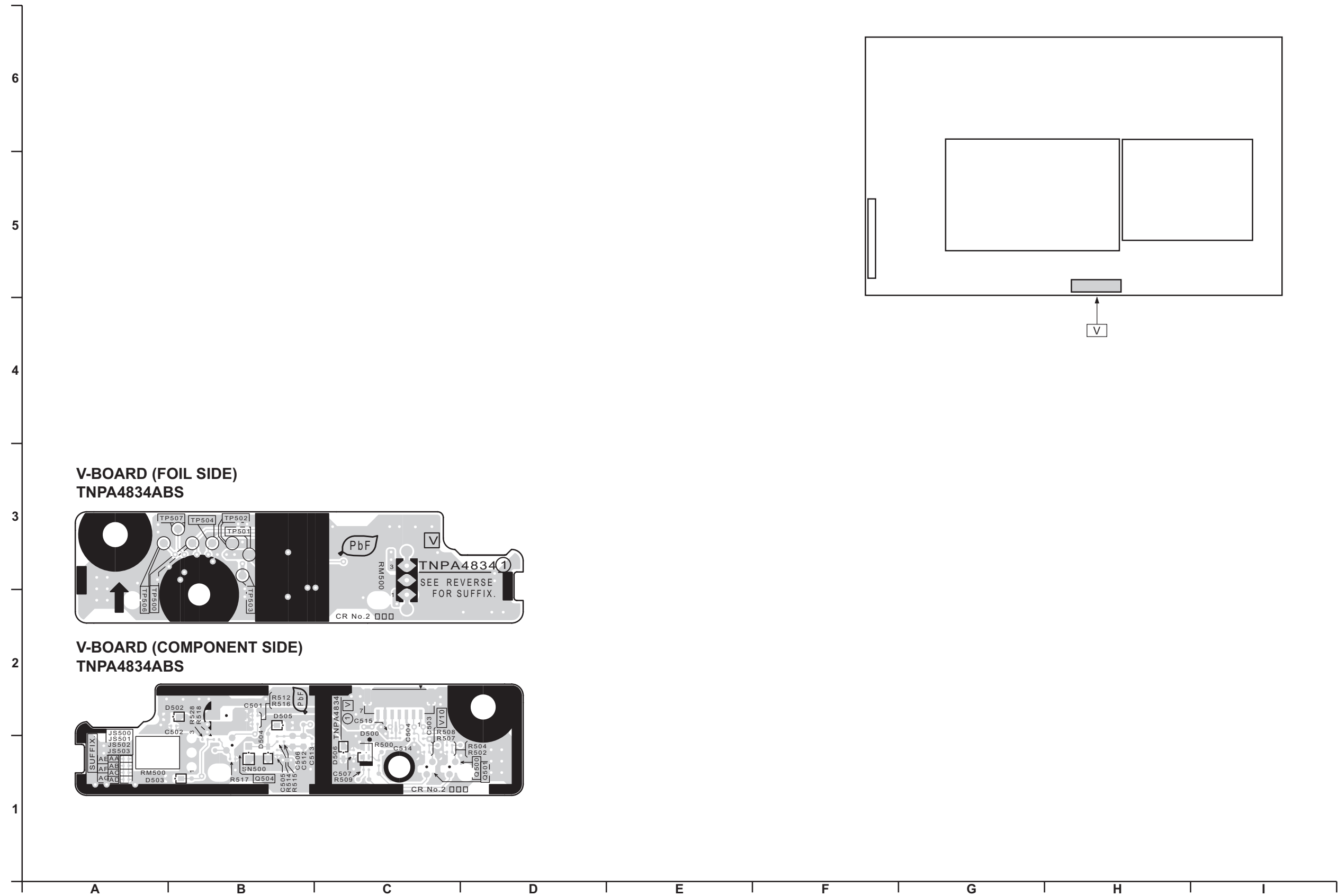

13 Exploded View and Replacement Parts List

13.1. Exploded View and Mechanical Replacement Parts List

13.1.1. Exploded View

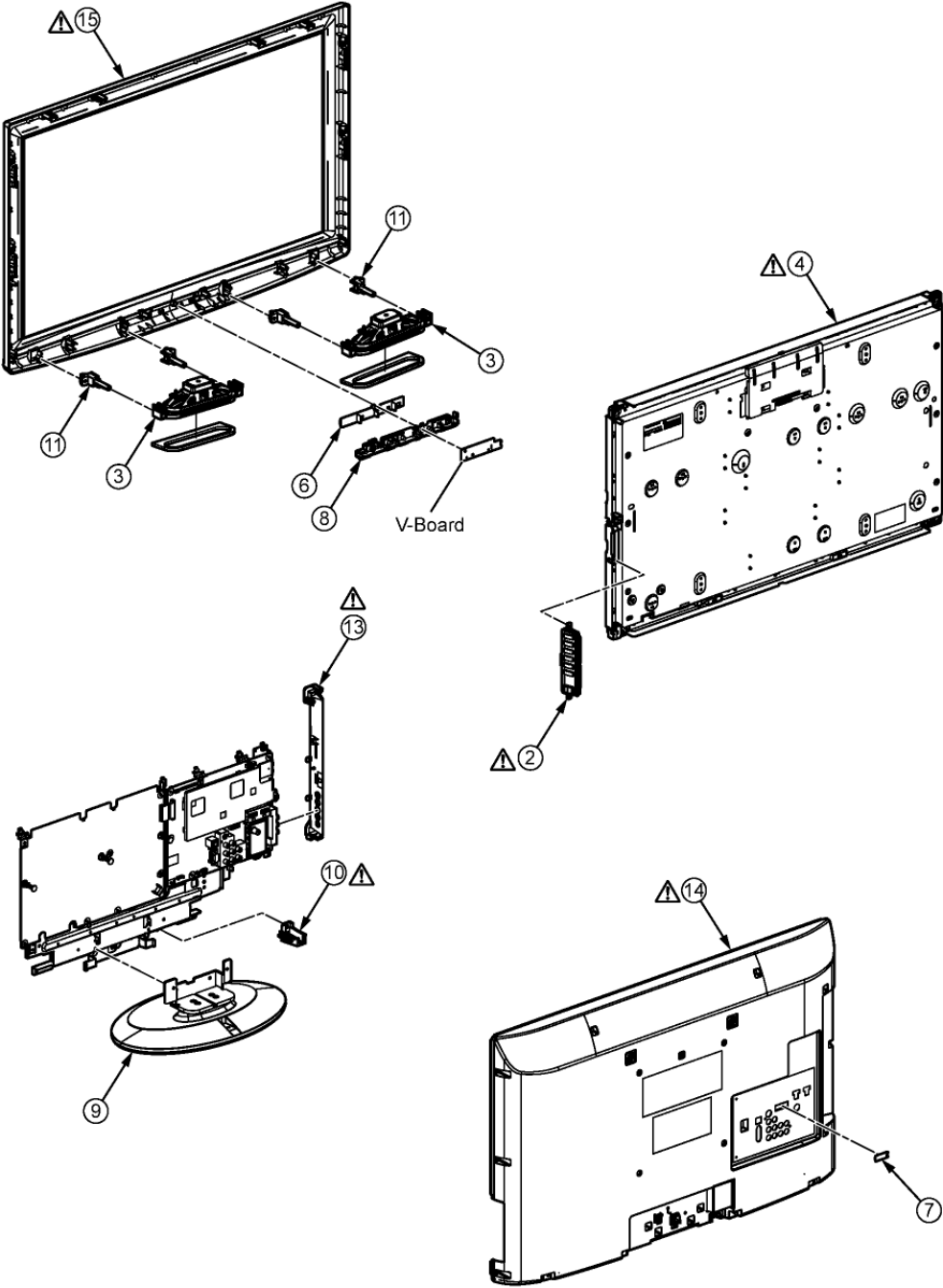



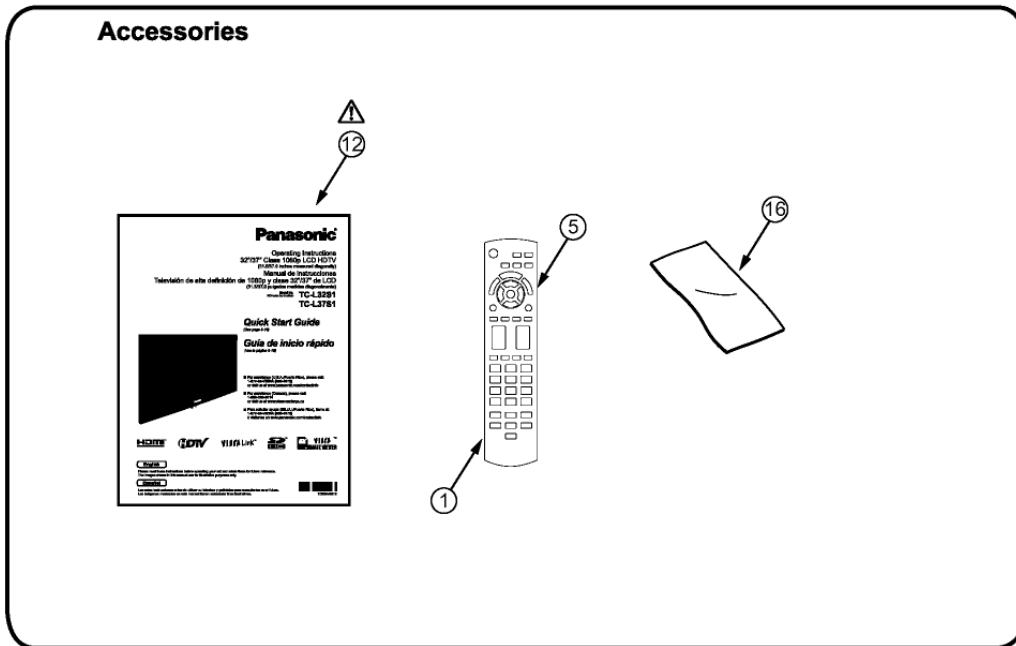









13.1.2. Accessory



13.1.3. Mechanical Replacement Parts List

Note: All parts except parts mentioned [PAVCA] in the Remarks column are supplied by AVC-CSPC.
Parts mentioned [PAVCA] are supplied by PAVCA.

Safety	Ref. No.	Part No.	Part Name & Description	Q'ty	Remarks
	1	10030-0047500	BATTERY COVER	1	PAVCA
	2	K0RB00700013	CONTROLE PANEL ASSY	1	CIRCUIT BOARD&PANERL PAVCA
		K1PY51Y00019	LVDS LEAD	1	PAVCA 32 INCH
		K1PY51Y00021	LVDS LEAD	1	PAVCA 37 INCH
		K2CB2YY00006	AC CORD	1	PAVCA 37 INCH
		K2CB2YY00008	AC CORD	1	PAVCA 32 INCH
	3	L0AA16200002	SP UNIT	2	PAVCA
	4	L5EDD8T00007	LCD PANEL	1	PAVCA 32 INCH
	4	L5EDD9T00012	LCD PANEL	1	PAVCA 37 INCH
	5	N2QAYB000321	REMOTE CONTROLLER	1	PAVCA
		TEWF091	AL/PET TAPE 15x80	2	PAVCA 37 INCH
		TEWF097	AL-TAPE (15*40)	2	PAVCA 32 INCH
		THEL047J	SCREW(HDMI:2)	3	
		THTD020J	SCREW(A8/P5)	13	
	6	TKK2AA10101	LED-SHADE-RIB	1	PAVCA
	7	TKK2AA7901	COVER (ADJ. WINDOW)	1	PAVCA
	8	TKK2AA9901	LED PANEL	1	PAVCA
	9	TKX2AA0341	PEDESTAL COVER	1	PAVCA 37 INCH
	9	TKX2AA0351	PEDESTAL COVER	1	PAVCA 32 INCH
		TMK2AA01063	FELT TAPE (t0.4*W20*L75)	1	PAVCA 32 INCH
		TMK2AG07601	LVDS SPONGE	1	PAVCA 37 INCH
		TMK2AG07601	SPONGE t3*w28*L1:55*L2:27	1	PAVCA 37 INCH
		TMK2AG08501	SP SPONGE	2	PAVCA 32 INCH
		TMK2AG08601	SP SPONGE	2	PAVCA 37 INCH
		TMK2AG09601	SPONGE (10*40*t6)	3	PAVCA 32 INCH
		TMK2AG09601	SPONGE (10*40*t6)	4	PAVCA 37 INCH
		TMK2AG09701	SPONGE (10*120*t6)	1	PAVCA 32 INCH
		TMK2AG098	SPONGE (15*35*T10)	1	PAVCA
		TMK2AG099	LVDS SPONGE	2	PAVCA 32 INCH
		TMME047	CLAMPER	1	32 INCH
		TMME268	CLAMPER	11	32 INCH
		TMME268	CLAMPER	9	37 INCH
		TMME340	CLAMPER	1	
		TMME342	CLAMPER (P1)	1	
		TMMX246	SUPPORT MOLD A	3	
	10	TMW2AA051	AC CODE BRACKET	1	PAVCA
	11	TMW2AA061	SP BRACKET	4	PAVCA
	12	TQB2AA0816	INSTRUCTION BOOK	1	PAVCA
	13	TXFKP05WSER	SIDE AV BRACKET	1	PAVCA
	14	TXFKU05WSER	REAR COVER	1	PAVCA 32 INCH
	14	TXFKU06WSER	REAR COVER	1	PAVCA 37 INCH
	15	TXFKY010PQG	CABINET ASSY	1	PAVCA 37 INCH
	15	TXFKY010PRG	CABINET ASSY	1	PAVCA 32 INCH

Safety	Ref. No.	Part No.	Part Name & Description	Q'ty	Remarks
	16	TXFPE01RLTU	CLEANING CLOTH ASSY	1	
		TXJA100PRG	SPEAKER LEAD (A10-V10)	1	PAVCA 32 INCH
		TXJA150PQG	SPEAKER LEAD (A15-SP)	1	PAVCA 37 INCH
		XTB4+12JFJ	SCREW	2	
		XTB4+15JFJ	SCREW	15	32 INCH
		XTB4+15JFJ	SCREW	17	37 INCH
		XTB4+15JFJK	SCREW	2	
		XTB4+18JFJK	SCREW (BCX11)	15	
		XTV3+10GFJK	SCREW (REAR BRKT2)	2	
		XTW3+12TFJ	SCREW	4	
		XYM4+C10FJK	SCREW	4	
		XYM4+C10FJK	SCREW (PEDE4)	4	
		XYN4+F6FJ	SCREW (LCD BTM MTG)	14	

13.2. Electrical Replacement Parts List

13.2.1. Replacement Parts List Notes

RTL (Retention Time Limited)

Note: The marking (RTL) indicates that the Retention Time is Limited for this item.

After the discontinuation of this assembly in production, the item will continue to be available for a specific period of time. The retention period of availability is dependant on the type of assembly, and in accordance with the laws governing part and product retention. After the end of this period, the assembly will no longer be available.

Abbreviation of part name and description

1. Resistor

Example:

ERD25TJ104 C 100KOHM, J, 1/4W
 Type Allowance

2. Capacitor

Example:

ECKF1H103ZF C 0.01UF, Z, 50V
 Type Allowance

Type	Allowance
C : Carbon	F : ±1%
F : Fuse	G : ±2%
M : Metal Oxide Metal Film	J : ±5%
S : Solid	K : ±10%
W : Wire Wound	M : ±20%

Type	Allowance
C : Ceramic	C : ±0.25pF
E : Electrolytic	D : ±0.5pF
P : Polyester	F : ±1pF
Polypropylene	G : ±3pF
Tantalum	J : ±5pF
	K : ±10pF
	L : ±15pF
	M : ±20pF
	P : +100%, -0%
	Z : +80%, -20%

Safety	Ref. No.	Part No.	Part Name & Description	Pcs	Remarks
	C4346	FIG1C103A116	C 0.010UF, K, 16V	1	
	C4347	FIG1C104A116	C 0.10UF, K, 16V	1	
	C4348	FIG1C103A116	C 0.010UF, K, 16V	1	
	C4349,50	FLH0J1050012	C 1UF, K, 16V	2	
	C4351,52	FIG1C104A116	C 0.10UF, K, 16V	2	
	C4353,54	FIG1C103A116	C 0.010UF, K, 16V	2	
	C4355	FLJ0J106A020	C 0.010UF, K, 16V	1	
	C4500-03	FIG1C104A116	C 0.10UF, K, 16V	4	
	C4533	FIG1H680A731	C 68UF, 50V	1	
	C4534,35	FLH1C104A143	C 0.1UF, K, 16V	2	
	C4547	FIG1C104A116	C 0.10UF, K, 16V	1	
	C4548,49	FLH1C104A143	C 0.1UF, K, 16V	2	
	C4550	FIG1C104A116	C 0.10UF, K, 16V	1	
	C4551,52	FLH1C104A143	C 0.1UF, K, 16V	2	
	C4553	FIG1H102A730	C 1000UF, 50V	1	
	C4554	F2G1C470A022	E 47UF, 16V	1	
	C4555	FLJ1A106A043	C 0.010UF, K, 10V	1	
	C4574,75	FIG1C104A116	C 0.10UF, K, 16V	2	
	C4585	FIG1C104A116	C 0.10UF, K, 16V	1	
	C4595,96	FIG1C104A116	C 0.10UF, K, 16V	2	
	C4598,99	FLJ1A106A043	C 0.010UF, K, 10V	2	
	C4600	FIG1C104A116	C 0.10UF, K, 16V	1	
	C4601	FLJ1A106A043	C 0.010UF, K, 10V	1	
	C4602	FIG1C104A116	C 0.10UF, K, 16V	1	
	C4603	FLH0J2250008	C 2.2UF, K, 16V	1	
	C4604	FIG1H471A730	C 470UF, 50V	1	
	C4605	FLH1A1050032	C 10UF, 50V	1	
	C4606	FLJ1A475A039	C 4.7UF, K, 10V	1	
	C4607	FLJ0G2260001	C 0.001UF, 6.3V	1	
	C4608	FIG1C104A116	C 0.10UF, K, 16V	1	
	C4612	FIG1C104A116	C 0.10UF, K, 16V	1	
	C4613	FLH1A1050032	C 10UF, 50V	1	
	C4614	FIG1C104A116	C 0.10UF, K, 16V	1	
	C4616	FLJ1A475A039	C 4.7UF, K, 10V	1	
	C4617	FLJ0G2260001	C 0.001UF, 6.3V	1	
	C4619	FIG1C104A116	C 0.10UF, K, 16V	1	
	C4624,25	FLH1C104A143	C 0.1UF, K, 16V	2	
	C4626	FIG1C104A116	C 0.10UF, K, 16V	1	
	C4628-30	FIG1C104A116	C 0.10UF, K, 16V	3	
	C4631	FLJ1A106A043	C 0.010UF, K, 10V	1	
	C4633	FLJ1A106A043	C 0.010UF, K, 10V	1	
	C4634	FIG1C104A116	C 0.10UF, K, 16V	1	
	C4635	FLJ1A106A043	C 0.010UF, K, 10V	1	
	C4636,37	FIG1C104A116	C 0.10UF, K, 16V	2	
	C4640-45	FIG1C104A116	C 0.10UF, K, 16V	6	
	C4647	FIG1C104A116	C 0.10UF, K, 16V	1	
	C4800	FIG1C104A116	C 0.10UF, K, 16V	1	
	C4801	FLH1H103A970	C 0.001UF, K, 50V	1	
	C4802	EEH1C470P	C 47PF, J, 16V	1	
	C4803,04	FLJ1A106A043	C 0.010UF, K, 10V	2	
	C4805	F2G0J220A019	E 100UF 6.3V	1	
	C4806	FIG1C104A116	C 0.10UF, K, 16V	1	
	C4840	FLH1H103A970	C 0.001UF, K, 50V	1	
	C5408	FLJ1A106A043	C 0.010UF, K, 10V	1	
	C5409	FIG1E103A123	C 0.010UF, K, 25V	1	
	C5410	FLJ1E105A171	C 1 UF 25V	1	
	C5414,15	FLJ1E105A171	C 1 UF 25V	2	
	C5421	FLJ1A106A043	C 0.010UF, K, 10V	1	
	C5431	FLJ1E105A171	C 1 UF 25V	1	
	C5461	FLH1E104A129	C 0.1UF, 25V	1	

Safety	Ref. No.	Part No.	Part Name & Description	Pcs	Remarks
	C5462	FIG1C104A116	C 0.10UF, K, 16V	1	
	C5463	FLK1C1060004	C 0.010UF, 16V	1	
	C5480	FIG1C103A116	C 0.010UF, K, 16V	1	
	C5481	FLH1A1050032	C 10UF, 50V	1	
	C5483	FLJ1A106A043	C 0.010UF, K, 10V	1	
	C5486	FIG1C473A081	C 0.047UF, K, 16V	1	
	C5487	FLH1C105A008	C 1UF, K, 16V	1	
	C5488	FIG1C473A081	C 0.047UF, K, 16V	1	
	C5489	FLJ1A106A043	C 0.010UF, K, 10V	1	
	C5492	FIG1C104A116	C 0.10UF, K, 16V	1	
	C5493	FLH1A1050032	C 10UF, 50V	1	
	C5494	FLH1C105A145	C 0.01UF, K, 16V	1	
	C5497	FIG1C104A116	C 0.10UF, K, 16V	1	
	C5500	FIG1C103A116	C 0.010UF, K, 16V	1	
	C5537	F2G1V100A020	E 10UF, 35V	1	
	C5538	FLH1H102A970	C 1000PF, K, 50V	1	
	C5539	ECJ3YB1C106M	C 10UF, M,16V	1	
	C5540	FLJ1H47A757	C 0.47UF, 50V	1	
	C5602	ECGRLOG680ER	C 68UF, J, 4V	1	
	C5603	FIG1C104A116	C 0.10UF, K, 16V	1	
	C5604	FIG1E6820007	C 6800UF, Z, 25V	1	
	C5605	FLJ1A475A039	C 4.7UF, K, 10V	1	
	C5606	FLH1C105A145	C 0.01UF, K, 16V	1	
	C5607	FIG1H221A459	C 220UF, 50V	1	
	C5611,12	FLK1C1060004	C 0.010UF, 16V	2	
	C5615	FLK1C1060004	C 0.010UF, 16V	1	
	C5616	FIG1C273A081	C 0.027UF, K, 16V	1	
	C5618,19	FLK1C1060004	C 0.010UF, 16V	2	
	C5620	FLH1C104A143	C 0.1UF, K, 16V	1	
	C5621	FIG1E103A123	C 0.010UF, K, 25V	1	
	C5622	FLJ1A475A039	C 4.7UF, K, 10V	1	
	C5623	FIG1H221A459	C 220UF, 50V	1	
	C5624	FIG1H471A730	C 470UF, 50V	1	
	C5626,27	FIG1C104A116	C 0.10UF, K, 16V	2	
	C5628,29	ECGRLOE680ER	C 68UF, J, 2.5V	2	
	C5631	F2G1C470A022	E 47UF, 16V	1	
	C5632	FIG1C103A116	C 0.010UF, K, 16V	1	
	C5636-41	FIG1C104A116	C 0.10UF, K, 16V	6	
	C5642	FLK1C1060004	C 0.010UF, 16V	1	
	C5643	FLH1C104A143	C 0.1UF, K, 16V	1	
	C5644	FLH1C105A145	C 0.01UF, K, 16V	1	
	C5645	FLJ1H47A757	C 0.47UF, 50V	1	
	C5651,52	FLH1E104A129	C 0.1UF, 25V	2	
	C5653,54	FLH1A1050032	C 10UF, 50V	2	
	C5658-64	FLH1C105A145	C 0.01UF, K, 16V	7	
	C5665	FLH1A1050032	C 10UF, 50V	1	
	C5666-78	FLH1C105A145	C 0.01UF, K, 16V	13	
	C5679-84	FIG1C104A116	C 0.10UF, K, 16V	6	
	C5685	FLH1E104A129	C 0.1UF, 25V	1	
	C5686-91	FIG1C104A116	C 0.10UF, K, 16V	6	
	C5692,93	FLH1E104A129	C 0.1UF, 25V	2	
	C8001	FIG1C104A116	C 0.10UF, K, 16V	1	
	C8002-05	FLH0J1050012	C 1UF, K, 16V	4	
	C8006-08	FIG1C104A116	C 0.10UF, K, 16V	3	
	C8009,10	FLJ1A106A043	C 0.010UF, K, 10V	2	
	C8011-14	FIG1C104A116	C 0.10UF, K, 16V	4	
	C8015,16	FLH0J1050012	C 1UF, K, 16V	2	
	C8017	FLJ1A106A043	C 0.010UF, K, 10V	1	
	C8018-21	FIG1C104A116	C 0.10UF, K, 16V	4	
	C8022	FLH0J1050012	C 1UF, K, 16V	1	
	C8023,24	FLJ1A106A043	C 0.010UF, K, 10V	2	
	C8025-29	FIG1C104A116	C 0.10UF, K, 16V	5	
	C8030,31	FLH0J1050012	C 1UF, K, 16V	2	

Safety	Ref. No.	Part No.	Part Name & Description	Pcs	Remarks
	C8032	FIJ1A106A043	C 0.010UF, K, 10V	1	
	C8033,34	FIG1C104A116	C 0.10UF, K, 16V	2	
	C8035,36	FIJ1A106A043	C 0.010UF, K, 10V	2	
	C8037-41	FIG1C104A116	C 0.10UF, K, 16V	5	
	C8042	ECGRL0G680ER	C 68UF, J, 4V	1	
	C8043-51	FIG1C104A116	C 0.10UF, K, 16V	9	
	C8052	FIH0J1050012	C 1UF, K, 16V	1	
	C8053	FIG1C103A116	C 0.010UF, K, 16V	1	
	C8056,57	FIG1C104A116	C 0.10UF, K, 16V	2	
	C8058	FIJ1A106A043	C 0.010UF, K, 10V	1	
	C8067	FIG1C103A116	C 0.010UF, K, 16V	1	
	C8068	FIG1C104A116	C 0.10UF, K, 16V	1	
	C8069	FIG1H820A731	C 82UF, 50V	1	
	C8070-74	FIG1C104A116	C 0.10UF, K, 16V	5	
	C8075	FIJ1A106A043	C 0.010UF, K, 10V	1	
	C8076-80	FIG1C104A116	C 0.10UF, K, 16V	5	
	C8081	FIG1C103A116	C 0.010UF, K, 16V	1	
	C8301-03	FIG1H221A731	C 220UF, 50V	3	
	C8307	FIG1H102A730	C 1000UF, 50V	1	
	C8308	FIG1H103A735	C 0.01UF, 50V	1	
	C8309	FIG1H102A730	C 1000UF, 50V	1	
	C8310	FIG1C104A116	C 0.10UF, K, 16V	1	
	C8311	F2G1V220A020	E 22UF, 35V	1	
	C8312	FIG1C104A116	C 0.10UF, K, 16V	1	
	C8313,14	F2G0J2210013	E 220UF 6.3V	2	
	C8315,16	FIG1H102A730	C 1000UF, 50V	2	
	C8321	FIG1H121A731	C 120PF, K, 50V	1	PAVCA
	C8322,23	FIG1H102A730	C 1000UF, 50V	2	
	C8324,25	FIG1C104A116	C 0.10UF, K, 16V	2	
	C8326	FIG1C103A116	C 0.010UF, K, 16V	1	
	C8327,28	FIG1C104A116	C 0.10UF, K, 16V	2	
	C8329,30	FIJ1A106A043	C 0.010UF, K, 10V	2	
	C8331-35	FIG1C104A116	C 0.10UF, K, 16V	5	
	C8336	FIG1H120A731	C 12UF, 50V	1	
	C8337	FIG1C104A116	C 0.10UF, K, 16V	1	
	C8338	FIG1H150A731	C 15UF, 50V	1	
	C8339-42	FIG1C104A116	C 0.10UF, K, 16V	4	
	C8343	FIH0J1050012	C 1UF, K, 16V	1	
	C8344,45	FIJ1A106A043	C 0.010UF, K, 10V	2	
	C8370	FIG1H102A730	C 1000UF, 50V	1	
	C8371	FIH1H104A970	C 0.1UF, K, 50V	1	
	C8372	FIJ1A106A043	C 0.010UF, K, 10V	1	
	C8373	FIG1C104A116	C 0.10UF, K, 16V	1	
	C8374,75	FIJ1A106A043	C 0.010UF, K, 10V	2	
	C8376	FIG1C103A116	C 0.010UF, K, 16V	1	
	C8377	FIG1C104A116	C 0.10UF, K, 16V	1	
	C8378	FIG1C103A116	C 0.010UF, K, 16V	1	
	C8379	FIG1C104A116	C 0.10UF, K, 16V	1	
	C8380	FIG1H103A735	C 0.01UF, 50V	1	
	C8381	FIG1C104A116	C 0.10UF, K, 16V	1	
	C8382	FIG1C103A116	C 0.010UF, K, 16V	1	
	C8500,01	FIG1C104A116	C 0.10UF, K, 16V	2	
	C8506	FIG1C104A116	C 0.10UF, K, 16V	1	
	C8517	FIG1C104A116	C 0.10UF, K, 16V	1	
	C8533	FIG1C104A116	C 0.10UF, K, 16V	1	
	C8534	F2G1C470A022	E 47UF, 16V	1	
	C8537	ECJ2XF1C225Z	C 2.2UF, Z, 16V	1	
	D1114	MA3X704A0L	ZENER DIODE	1	
	D2100	BOHCMM000014	DIODE	1	
	D2303,04	MA2J11100L	DIODE	2	

Safety	Ref. No.	Part No.	Part Name & Description	Pcs	Remarks
	D2305	MA2J72800L	ZENER DIODE	1	
	D2306-08	MA2J11100L	DIODE	3	
	D2500A	B3AAB0000343	LED	1	PAVCA
	D2753	B3AEB0000131	DIODE	1	32 inch
	D2754	B3AEB0000131	DIODE	1	37 inch
	D3001,02	EZJP0V080GA	VARISTOR	2	
	D3013-15	EZJP0V080GA	VARISTOR	3	
	D3023	EZJP0V080GA	VARISTOR	1	
	D3025-27	EZJP0V080GA	VARISTOR	3	
	D3050	K7AAAY000005	PHOTO LINK	1	
	D3064,65	EZJP0V080GA	VARISTOR	2	
	D3079-83	EZJP0V080GA	VARISTOR	5	
	D3701-03	EZJP0V080GA	VARISTOR	3	
	D3708-10	EZJP0V080GA	VARISTOR	3	
	D4101,02	EZJP0V080GA	VARISTOR	2	
	D4502-12	EZAEG2A50AX	DIODE	11	
	D4513	B0BC5R6A0275	DIODE	1	
	D4514	EZAEG2A50AX	DIODE	1	
	D4515	B0BC5R6A0275	DIODE	1	
	D4516-23	EZAEG2A50AX	DIODE	8	
	D4541,42	MA2J11100L	DIODE	2	
	D4576	B0HCMM000014	DIODE	1	
	D4599-09	EZAEG2A50AX	DIODE	11	
	D4610	B0BC5R6A0275	DIODE	1	
	D4612	MA2J11100L	DIODE	1	
	D4615,16	MA2J11100L	DIODE	2	
	D4617	B0BC5R6A0275	DIODE	1	
	D4618	MA2J11100L	DIODE	1	
	D4619,20	B0BC5R6A0275	DIODE	2	
	D4800	MA2J11100L	DIODE	1	
	D5407	MA2J11100L	DIODE	1	
	D5414	MA2J11100L	DIODE	1	
	D5415	MA3X78900L	ZENER DIODE	1	
	D5416	B0BC03900015	ZENER DIODE	1	
	D5500	MA22F2000L	DIODE	1	
	D5612	MAZ80470ML	ZENER DIODE	1	
	D5613	MA2J11100L	DIODE	1	
	D5618	MAZ80470ML	ZENER DIODE	1	
	D5619	MA2J11100L	DIODE	1	
	D5626	MAZ80470ML	ZENER DIODE	1	
	D5627	MA2J11100L	DIODE	1	
	D5711,12	MA2J11100L	DIODE	2	
	D5713	MAZ81800ML	ZENER DIODE	1	
	D5714	MA2J11100L	DIODE	1	
	D5715	MAZ81100ML	ZENER DIODE	1	
	D5716	MA2J11100L	DIODE	1	
	D7084	MAZ82400ML	DIODE	1	
	D7085	MA2J11100L	DIODE	1	
	FL4206	ECJ1VB0J474K	C 0.47UF, K, 6.3V	1	
	FL4800-04	EXC28CE201U	NW_R(X4)	5	
	IC1102	MNZSFH9GP83	IC	1	PAVCA
	IC1103	TVRQ541S	IC	1	PAVCA 32 inch
	IC1103	TVRQ534S	IC	1	PAVCA 37 inch
	IC2008	C0CBCBE00001	IC	1	
	IC2301	C1AB00002875	IC	1	
	IC2302	C0EBF0000354	IC	1	
	IC3001	C1AB00002855	IC	1	
	IC4202	C0JBCZ000558	IC	1	
	IC4510	C1AB00003048	IC	1	
	IC4511	C0CBCBE00001	IC	1	
	IC4512,13	C0DBGY00477	IC	2	
	IC4700	C1ZBZ0003577	IC	1	
	IC5405	C0DBEY000016	IC	1	
	IC5409	C0DBEHE00005	IC	1	
	IC5480	C1ZBZ0003986	IC	1	
	IC5481	C0DBAJB00004	IC	1	
	IC5600,01	C0DBAYY00480	IC	2	
	IC8001	MN2WS0047	IC	1	
	IC8002,03	C3ABSY000036	IC	2	

Safety	Ref. No.	Part No.	Part Name & Description	Pcs	Remarks
	IC8004	COZBZ0001030	IC	1	
	IC8300	MN88436	IC	1	PAVCA
	IC8502	TVRQ535AAS	IC	1	PAVCA
	IC8503	TVRQ539S	IC	1	PAVCA 32 inch
	IC8503	TVRQ537AAS	IC	1	PAVCA 37 inch
	JK3001	K4AK17A00001	TERMINAL BOARD	1	PAVCA
	JK3104	K1FB315A0006	CONNECTOR	1	
	JK4500,01	K1FY119D0006	CONNECTOR	2	
	JK4503	K1FY119E0005	CONNECTOR	1	
	JK4800	K4AK16B00001	TERMINAL BOARD	1	
	JK8302	K1NA09E00080	9P CONNECTOR	1	
	JS2501	DOYAR0000007	M 0 OHM 1/4W	1	
	L1101	J0JYC0000068	CHIP INDUCTOR	1	
	L2005,06	J0JHC0000045	CHIP INDUCTOR	2	
	L2032	J0JYC0000068	CHIP INDUCTOR	1	
	L2300	G1C220MA0291	INDUCTION COIL	1	
	L2302	G1C220MA0291	INDUCTION COIL	1	
	L2304	G1C220MA0291	INDUCTION COIL	1	
	L2306	G1C220MA0291	INDUCTION COIL	1	
	L2843	J0JCC0000059	CHIP INDUCTOR	1	
	L3001,02	J0JHC0000117	CHIP INDUCTOR	2	
	L4209,10	J0JHC0000117	CHIP INDUCTOR	2	
	L4502-07	J0JYC0000068	CHIP INDUCTOR	6	
	L4511	J0JYC0000068	CHIP INDUCTOR	1	
	L4512,13	J0JCC0000059	CHIP INDUCTOR	2	
	L4514-19	J0JYC0000068	CHIP INDUCTOR	6	
	L4523-25	J0JYC0000068	CHIP INDUCTOR	3	
	L4800	J0JYC0000068	CHIP INDUCTOR	1	
	L4801	G1C100MA0072	INDUCTION COIL	1	
	L4802	J0JHC0000045	CHIP INDUCTOR	1	
	L5420	J0JHC0000042	CHIP INDUCTOR	1	
	L5430	J0JHC0000096	CHIP INDUCTOR	1	
	L5480,81	J0JYC0000068	CHIP INDUCTOR	2	
	L5483	G1C470MA0077	INDUCTION COIL	1	
	L5484	G1C100MA0072	INDUCTION COIL	1	
	L5600	G1C4R7Z00014	INDUCTION COIL	1	
	L5601	G1C3R3Z00004	INDUCTION COIL	1	
	L5602	G1C2R2Z00007	INDUCTION COIL	1	
	L5604	G1C100MA0203	INDUCTION COIL	1	
	L5605	J0JHC0000045	CHIP INDUCTOR	1	
	L5608	G1C100MA0077	INDUCTION COIL	1	
	L8001-05	J0JHC0000045	CHIP INDUCTOR	5	
	L8007-10	J0JHC0000045	CHIP INDUCTOR	4	
	L8111,12	DOYAR0000007	M 0 OHM 1/4W	2	
	L8300-02	J0JHC0000045	CHIP INDUCTOR	3	
	L8303,04	G1CR39JA0020	INDUCTION COIL	2	PAVCA
	L8305	G1CR10JA0020	INDUCTION COIL	1	PAVCA
	L8306-09	J0JHC0000045	CHIP INDUCTOR	4	
	L8500	J0JHC0000075	CHIP INDUCTOR	1	
	L8507	J0JHC0000045	CHIP INDUCTOR	1	
	L8509	J0JAC0000006	CHIP INDUCTOR	1	
	PA4201	ERBSE2R50U	FUSE	1	
	PA5400	K5H1622A0023	FUSE	1	
	PA5402	ERJ3GEY0R00	M 0 OHM, 1/16W	1	
	PA5601	ERBSE2R50U	FUSE	1	
	Q2063,64	2SD0601ASL	TRANSISTOR	2	
	Q2065	2SB0709ASL	TRANSISTOR	1	
	Q2301	B1ADCE000022	TRANSISTOR	1	
	Q2302	B1ABCF000231	TRANSISTOR	1	
	Q2304	B1ADCE000022	TRANSISTOR	1	
	Q2309	2SB0709ASL	TRANSISTOR	1	
	Q2500	B1ABCF000231	TRANSISTOR	1	
	Q2504	B1ABCF000231	TRANSISTOR	1	
	Q4500,01	B1ABCF000231	TRANSISTOR	2	
	Q4514-17	2SB0709ASL	TRANSISTOR	4	
	Q4532	B1ABCF000231	TRANSISTOR	1	
	Q4535-37	B1ABCF000231	TRANSISTOR	3	

Safety	Ref. No.	Part No.	Part Name & Description	Pcs	Remarks
	Q4800,01	B1ABCF000231	TRANSISTOR	2	
	Q4802	B1ADCE000022	TRANSISTOR	1	
	Q4803-07	B1ABCF000231	TRANSISTOR	5	
	Q5407,08	2SC584500L	TRANSISTOR	2	
	Q5412	B1CHRE000005	TRANSISTOR	1	
	Q5417	B1CHRE000005	TRANSISTOR	1	
	Q5421	2SC584500L	TRANSISTOR	1	
	Q5431	2SC584500L	TRANSISTOR	1	
	Q5432	B1CFNG000001	FET	1	
	Q5433	2SB0709ASL	TRANSISTOR	1	
	Q5434	2SD0601ASL	TRANSISTOR	1	
	Q5495	2SC584500L	TRANSISTOR	1	
	Q5600-02	B1MBDDA00003	FET	3	
	Q8300	2SB0709ASL	TRANSISTOR	1	
	R1140	ERJ2GEJ473	M 47KOHM, J,0.063W	1	
	R1146	ERJ2GEJ102X	M 1K OHM J 1/4W	1	
	R1149	ERJ2GEJ182	M 1.8KOHM, J,0.063W	1	
	R1174,75	ERJ2GEJ220	M 22 OHM, J,0.063W	2	
	R1183,84	ERJ2GEJ220	M 22 OHM, J,0.063W	2	
	R1197	ERJ2GEJ473	M 47KOHM, J,0.063W	1	
	R1200,01	ERJ2GEJ472	M 4.7KOHM, J,0.063W	2	
	R1205,06	ERJ2GEJ220	M 22 OHM, J,0.063W	2	
	R1211	ERJ2GEJ473	M 47KOHM, J,0.063W	1	
	R1213	ERJ2GEJ101	M 100 OHM, J,0.063W	1	
	R1222,23	ERJ2GEJ473	M 47KOHM, J,0.063W	2	
	R1232	ERJ2GEJ681	M 680 OHM, J,0.063W	1	
	R1233	ERJ2GEJ105	M 1MOHM, J,0.063W	1	
	R1235	DOYAR0000007	M 0 OHM 1/4W	1	
	R1239	DOYAR0000007	M 0 OHM 1/4W	1	
	R1240	ERJ2GED273X	M 27KOHM, J,0.063W	1	
	R1241	DOYAR0000007	M 0 OHM 1/4W	1	
	R1245	ERJ2GEJ473	M 47KOHM, J,0.063W	1	
	R1246	DOYAR0000007	M 0 OHM 1/4W	1	
	R1249	ERJ2GEJ473	M 47KOHM, J,0.063W	1	
	R1250	D1BB7151A055	M7.15KOHM, 1/10W	1	
	R1251	ERJ2GEJ473	M 47KOHM, J,0.063W	1	
	R1253,54	ERJ2GEJ103	M 10KOHM, J,0.063W	2	
	R1256	ERJ2GEJ473	M 47KOHM, J,0.063W	1	
	R1258,59	DOYAR0000007	M 0 OHM 1/4W	2	
	R1260	ERJ2GEJ473	M 47KOHM, J,0.063W	1	
	R1261	ERJ2GEJ102X	M 1K OHM J 1/4W	1	
	R1262	ERJ2GEJ473	M 47KOHM, J,0.063W	1	
	R1263	ERJ2GEJ102X	M 1K OHM J 1/4W	1	
	R1266	ERJ2GEJ683	M 68KOHM, J,0.063W	1	
	R1267	ERJ2GEJ333	M 33KOHM, J,0.063W	1	
	R1268	ERJ2GEJ683	M 68KOHM, J,0.063W	1	
	R1269	ERJ2GEJ223	M 22KOHM, J,0.063W	1	
	R1270	ERJ2GEJ683	M 68KOHM, J,0.063W	1	
	R1271	ERJ2GEJ473	M 47KOHM, J,0.063W	1	
	R1273	ERJ2GEJ103	M 10KOHM, J,0.063W	1	

Safety	Ref. No.	Part No.	Part Name & Description	Pcs	Remarks
	R1274	ERJ2GEJ104	M 100KOHM, J,0.063W	1	
	R1283-85	ERJ2GEJ473	M 47KOHM, J,0.063W	3	
	R2002	ERJ2GEJ102X	M 1K OHM J 1/4W	1	
	R2003	ERJ2GEJ105	M 1MOHM, J,0.063W	1	
	R2008-10	ERJ2GEJ331	M 330 OHM, J,0.063W	3	
	R2012	ERJ2GEJ220	M 22 OHM, J,0.063W	1	
	R2017,18	ERJ2GEJ103	M 10KOHM, J,0.063W	2	
	R2019	D1BB2002A055	M 20KOHM, 1/10W	1	
	R2020	D1BB2001A055	M 2KOHM, 1/10W	1	
	R2023	ERJ2GEJ103	M 10KOHM, J,0.063W	1	
	R2026	D1BB1203A055	M 120KOHM, 1/10W	1	
	R2027	D1BB7502A055	M 75KOHM, 1/10W	1	
	R2039	DOYAR0000007	M 0 OHM 1/4W	1	32 inch
	R2050,51	D1BB2802A055	M 28KOHM, 1/10W	2	
	R2056,57	ERJ2GEJ220	M 22 OHM, J,0.063W	2	
	R2092,93	ERJ2GEJ103	M 10KOHM, J,0.063W	2	
	R2106,07	ERJ2GEJ101	M 100 OHM, J,0.063W	2	
	R2108	ERJ2GEJ105	M 1MOHM, J,0.063W	1	
	R2109	ERJ2GEJ274	M 270KOHM, J,0.063W	1	
	R2120	ERJ2GEJ473	M 47KOHM, J,0.063W	1	
	R2122	ERJ2GEJ102X	M 1K OHM J 1/4W	1	
	R2125	ERJ2GEJ222	M 2.2KOHM, J,0.063W	1	
	R2172	ERJ2GEJ680	M 68 OHM, J,0.063W	1	
	R2190	ERJ2GEJ103	M 10KOHM, J,0.063W	1	
	R2191	ERJ2GEJ104	M 100KOHM, J,0.063W	1	
	R2271	EXB28V220J	RESISTOR ARRAY	1	
	R2301,02	ERJ2GEJ222	M 2.2KOHM, J,0.063W	2	
	R2306	DOYAR0000007	M 0 OHM 1/4W	1	
	R2308	ERJ8GEYJ3R3V	M 3.3 OHM, J,1/8W	1	
	R2311	ERJ8GEYJ3R3V	M 3.3 OHM, J,1/8W	1	
	R2313	ERJ8GEYJ3R3V	M 3.3 OHM, J,1/8W	1	
	R2315	ERJ8GEYJ3R3V	M 3.3 OHM, J,1/8W	1	
	R2317	DOYAR0000007	M 0 OHM 1/4W	1	
	R2325	DOYAR0000007	M 0 OHM 1/4W	1	
	R2330	ERJ2GEJ392	M 3.9KOHM, J,0.063W	1	
	R2331	ERJ3GEYJ221	M 220 OHM, J,1/16W	1	
	R2350,51	ERJ2GEJ103	M 10KOHM, J,0.063W	2	
	R2352	ERJ2GEJ473	M 47KOHM, J,0.063W	1	
	R2353	ERJ2GEJ103	M 10KOHM, J,0.063W	1	
	R2354	ERJ2GEJ473	M 47KOHM, J,0.063W	1	
	R2359	ERJ2GEJ101	M 100 OHM, J,0.063W	1	
	R2360	ERJ2GEJ102X	M 1K OHM J 1/4W	1	
	R2361	ERJ2GEJ101	M 100 OHM, J,0.063W	1	
	R2362	ERJ2GEJ104	M 100KOHM, J,0.063W	1	
	R2374	ERJ2GEJ104	M 100KOHM, J,0.063W	1	
	R2375	ERJ2GED563X	M 56KOHM, J,0.063W	1	

Safety	Ref. No.	Part No.	Part Name & Description	Pcs	Remarks
	R2377	ERJ2GED563X	M 56KOHM, J,0.063W	1	
	R2379	ERJ2GEJ103	M 10KOHM, J,0.063W	1	
	R2380	ERJ2GEJ561	M 60 OHM, J,0.063W	1	
	R2381	ERJ2GEJ474	M 470KOHM, J,0.063W	1	
	R2382	ERJ2GEJ101	M 100 OHM, J,0.063W	1	
	R2383	ERJ2GEJ474	M 470KOHM, J,0.063W	1	
	R2384	ERJ2GEJ101	M 100 OHM, J,0.063W	1	
	R2385	ERJ2GEJ103	M 10KOHM, J,0.063W	1	
	R2502	ERJ2GEJ473	M 47KOHM, J,0.063W	1	
	R2504	ERJ2GEJ223	M 22KOHM, J,0.063W	1	
	R2509	ERJ2RKF6040X	M 604 OHM, 0.063W	1	PAVCA
	R2512	ERJ2GEJ470	M 47 OHM, J,0.063W	1	
	R2516	ERJ2GEJ473	M 47KOHM, J,0.063W	1	
	R2517	ERJ2GEJ104	M 100KOHM, J,0.063W	1	
	R2518	ERJ2GEJ103	M 10KOHM, J,0.063W	1	
	R2777	ERJ2GEJ473	M 47KOHM, J,0.063W	1	
	R2778	ERJ2GEJ103	M 10KOHM, J,0.063W	1	
	R2779,80	ERJ3GEYJ751	M 750 OHM, J,1/16W	2	
	R2832	ERJ2GEJ220	M 22 OHM, J,0.063W	1	
	R2834-37	ERJ2GEJ220	M 22 OHM, J,0.063W	4	
	R3001	ERJ2GEJ680	M 68 OHM, J,0.063W	1	
	R3002	ERJ2GEJ101	M 100 OHM, J,0.063W	1	
	R3003	ERJ2GEJ680	M 68 OHM, J,0.063W	1	
	R3006	ERJ2GEJ102X	M 1K OHM J 1/4W	1	
	R3007	ERJ2GEJ221	M 220 OHM, J,0.063W	1	
	R3009	ERJ2GEJ221	M 220 OHM, J,0.063W	1	
	R3011	ERJ2GEJ221	M 220 OHM, J,0.063W	1	
	R3017	ERJ2GEJ221	M 220 OHM, J,0.063W	1	
	R3026	ERJ2GEJ103	M 10KOHM, J,0.063W	1	
	R3028,29	ERJ2GEJ220	M 22 OHM, J,0.063W	2	
	R3032	ERJ2GEJ680	M 68 OHM, J,0.063W	1	
	R3034	ERJ2GEJ680	M 68 OHM, J,0.063W	1	
	R3049,50	ERJ2GEJ221	M 220 OHM, J,0.063W	2	
	R3058-61	ERJ2GEJ221	M 220 OHM, J,0.063W	4	
	R3064-69	ERJ2GEJ221	M 220 OHM, J,0.063W	6	
	R3077	ERJ2GEJ221	M 220 OHM, J,0.063W	1	
	R3084	ERJ2GEJ102X	M 1K OHM J 1/4W	1	
	R3093	ERJ2GEJ221	M 220 OHM, J,0.063W	1	
	R3095	ERJ2GEJ221	M 220 OHM, J,0.063W	1	
	R3096	DOYAR0000007	M 0 OHM 1/4W	1	
	R3097	ERJ2GEJ221	M 220 OHM, J,0.063W	1	

Safety	Ref. No.	Part No.	Part Name & Description	Pcs	Remarks
	R3099	ERJ2GEJ680	M 68 OHM, J,0.063W	1	
	R3100	ERJ2GEJ101	M 100 OHM, J,0.063W	1	
	R3104-06	ERJ6RED750	M 75 OHM, 1/10W	3	
	R3108,09	ERJ2GEJ472	M 4.7KOHM, J,0.063W	2	
	R3123	ERJ6RED750	M 75 OHM, 1/10W	1	
	R3155	ERJ2GEJ560X	M 56 OHM, J,0.063W	1	
	R3159	ERJ6RED750	M 75 OHM, 1/10W	1	
	R3160,61	ERJ2GEJ184	M 180KOHM, J,0.063W	2	
	R3164,65	ERJ2GEJ184	M 180KOHM, J,0.063W	2	
	R3172,73	ERJ2GEJ184	M 180KOHM, J,0.063W	2	
	R3174	ERJ2GEJ103	M 10KOHM, J,0.063W	1	
	R3175,76	ERJ6RED750	M 75 OHM, 1/10W	2	
	R3178	ERJ6RED750	M 75 OHM, 1/10W	1	
	R3701,02	ERJ6RED750	M 75 OHM, 1/10W	2	
	R3708,09	DOGDR00Z0002	M 0 OHM, 1/10W	2	
	R4079	EXB2HV560JV	RESISTOR ARRAY	1	
	R4081	EXB2HV560JV	RESISTOR ARRAY	1	
	R4089-91	EXB2HV560JV	RESISTOR ARRAY	3	
	R4168	EXB2HV473JV	RESISTOR ARRAY	1	
	R4333	ERJ2GEJ473	M 47KOHM, J,0.063W	1	
	R4334	ERJ2GEJ103	M 10KOHM, J,0.063W	1	
	R4336	ERJ2GEJ103	M 10KOHM, J,0.063W	1	
	R4339	DOYAR0000007	M 0 OHM 1/4W	1	
	R4340	ERJ2GEJ103	M 10KOHM, J,0.063W	1	
	R4343	DOYAR0000007	M 0 OHM 1/4W	1	
	R4344,45	ERJ2GEJ223	M 22KOHM, J,0.063W	2	
	R4346	DOYAR0000007	M 0 OHM 1/4W	1	
	R4347	ERJ2GEJ473	M 47KOHM, J,0.063W	1	
	R4358	DOYAR0000007	M 0 OHM 1/4W	1	
	R4400	ERJ2GEJ680	M 68 OHM, J,0.063W	1	
	R4401	ERJ2GEJ473	M 47KOHM, J,0.063W	1	
	R4402	DOYAR0000007	M 0 OHM 1/4W	1	
	R4406-08	EXB2HV151J	RESISTOR ARRAY	3	
	R4412	ERJ2GEJ680	M 68 OHM, J,0.063W	1	
	R4500,01	ERJ2GEJ103	M 10KOHM, J,0.063W	2	
	R4502,03	ERJ2RKD330	M 33 OHM, J, 2W	2	
	R4504,05	ERJ2GEJ102X	M 1K OHM J 1/4W	2	
	R4528	ERJ2GEJ103	M 10KOHM, J,0.063W	1	
	R4530	ERJ2GEJ103	M 10KOHM, J,0.063W	1	
	R4532,33	ERJ2GEJ473	M 47KOHM, J,0.063W	2	
	R4538	ERJ2GEJ473	M 47KOHM, J,0.063W	1	
	R4540	ERJ2GEJ473	M 47KOHM, J,0.063W	1	
	R4552	ERJ2GEJ220	M 22 OHM, J,0.063W	1	
	R4587	D1BB60400001	M 604 OHM, 1/10W	1	
	R4588,89	D1BB8060A055	M 806 OHM, 1/10W	2	
	R4592	D1BB8060A055	M 806 OHM, 1/10W	1	
	R4593	D1BB2201A055	M 2.2KOHM, 1/10W	1	
	R4596-98	ERJ6GEYJ102V	M 1K OHM J 1/10W	3	
	R4600	ERJ2GEJ680	M 68 OHM, J,0.063W	1	
	R4601	ERJ6GEYJ102V	M 1K OHM J 1/10W	1	
	R4603,04	ERJ2GEJ680	M 68 OHM, J,0.063W	2	

Safety	Ref. No.	Part No.	Part Name & Description	Pcs	Remarks
	R4605	ERJ2GEJ103	M 10KOHM, J,0.063W	1	
	R4606	D1BB9101A055	M 9.1KOHM, 1/10W	1	
	R4607	DOYAR0000007	M 0 OHM 1/4W	1	
	R4608	ERJ2GEJ473	M 47KOHM, J,0.063W	1	
	R4609,10	ERJ2GEJ680	M 68 OHM, J,0.063W	2	
	R4611	D1BB5601A055	M 5.6KOHM, 1/10W	1	
	R4613	ERJ2GEJ103	M 10KOHM, J,0.063W	1	
	R4616	ERJ2GEJ680	M 68 OHM, J,0.063W	1	
	R4618	DOYAR0000007	M 0 OHM 1/4W	1	
	R4619,20	ERJ2GEJ473	M 47KOHM, J,0.063W	2	
	R4622	DOYAR0000007	M 0 OHM 1/4W	1	
	R4624,25	ERJ2GEJ103	M 10KOHM, J,0.063W	2	
	R4626,27	D1BB2200A055	M 220 OHM, 1/10W	2	
	R4628,29	ERJ2GEJ101	M 100 OHM, J,0.063W	2	
	R4631	D1BB4990A055	M 499 OHM, 1/10W	1	
	R4634	D1BB2200A055	M 220 OHM, 1/10W	1	
	R4635	EXB28V680JX	RESISTOR ARRAY	1	
	R4636-38	ERJ2GEJ680	M 68 OHM, J,0.063W	3	
	R4639,40	EXB28V680JX	RESISTOR ARRAY	2	
	R4641-43	ERJ2GEJ473	M 47KOHM, J,0.063W	3	
	R4645,46	ERJ2GEJ680	M 68 OHM, J,0.063W	2	
	R4647	ERJ2GEJ473	M 47KOHM, J,0.063W	1	
	R4648	EXB28V330J	RESISTOR ARRAY	1	
	R4649	EXB28V680JX	RESISTOR ARRAY	1	
	R4650,51	ERJ2GEJ680	M 68 OHM, J,0.063W	2	
	R4652	ERJ2GEJ473	M 47KOHM, J,0.063W	1	
	R4653	ERJ2GEJ103	M 10KOHM, J,0.063W	1	
	R4654	DOYAR0000007	M 0 OHM 1/4W	1	
	R4656	ERJ2GEJ222	M 2.2KOHM, J,0.063W	1	
	R4657,58	ERJ2GEJ220	M 22 OHM, J,0.063W	2	
	R4659	DOYAR0000007	M 0 OHM 1/4W	1	
	R4660,61	ERJ2GEJ473	M 47KOHM, J,0.063W	2	
	R4662	ERJ2GEJ103	M 10KOHM, J,0.063W	1	
	R4665,66	ERJ2GEJ473	M 47KOHM, J,0.063W	2	
	R4670	ERJ2GEJ680	M 68 OHM, J,0.063W	1	
	R4672	ERJ2GEJ473	M 47KOHM, J,0.063W	1	
	R4673	DOYAR0000007	M 0 OHM 1/4W	1	
	R4674	ERJ2GEJ103	M 10KOHM, J,0.063W	1	
	R4677	ERJ2GEJ103	M 10KOHM, J,0.063W	1	
	R4678,79	EXB28V680JX	RESISTOR ARRAY	2	
	R4696-98	DOYAR0000007	M 0 OHM 1/4W	3	
	R4699	ERJ2GEJ104	M 100KOHM, J,0.063W	1	
	R4701-05	ERJ2GEJ473	M 47KOHM, J,0.063W	5	
	R4707	ERJ2GEJ473	M 47KOHM, J,0.063W	1	
	R4708,09	ERJ2GEJ103	M 10KOHM, J,0.063W	2	
	R4714	ERJ2GEJ103	M 10KOHM, J,0.063W	1	
	R4715	ERJ2GEJ473	M 47KOHM, J,0.063W	1	
	R4718	ERJ2GEJ473	M 47KOHM, J,0.063W	1	

Safety	Ref. No.	Part No.	Part Name & Description	Pcs	Remarks
	R4721	ERJ2GEJ680	M 68 OHM, J, 0.063W	1	
	R4723	ERJ2GEJ103	M 10KOHM, J, 0.063W	1	
	R4726	ERJ2RKD330	M 33 OHM, J, 2W	1	
	R4727	ERJ2GEJ102X	M 1K OHM J 1/4W	1	
	R4740	ERJ2GEJ680	M 68 OHM, J, 0.063W	1	
	R4801	ERJ2GEJ473	M 47KOHM, J, 0.063W	1	
	R4806	ERJ2GEJ103	M 10KOHM, J, 0.063W	1	
	R4808	ERJ2GEJ103	M 10KOHM, J, 0.063W	1	
	R4809	ERJ2GEJ102X	M 1K OHM J 1/4W	1	
	R4810	ERJ2GEJ473	M 47KOHM, J, 0.063W	1	
	R4811	ERJ2GEJ302	M 3KOHM, J, 0.063W	1	
	R4814, 15	ERJ2GEJ102X	M 1K OHM J 1/4W	2	
	R4816, 17	ERJ2GEJ103	M 10KOHM, J, 0.063W	2	
	R4818	ERJ2GEJ473	M 47KOHM, J, 0.063W	1	
	R4819	ERJ2GEJ103	M 10KOHM, J, 0.063W	1	
	R4820	ERJ2GEJ102X	M 1K OHM J 1/4W	1	
	R4821	ERJ2GEJ103	M 10KOHM, J, 0.063W	1	
	R4822, 23	ERJ2GEJ473	M 47KOHM, J, 0.063W	2	
	R4825	D1BD4871A044	M 4.87KOHM, 1/10W	1	
	R4827	ERJ2GEJ102X	M 1K OHM J 1/4W	1	
	R4828	ERJ2RKF3901	M 3.9KOHM, 0.063W	1	
	R4829	ERJ2GEJ100	M 10 OHM, J, 0.063W	1	
	R4845	ERJ2GEJ473	M 47KOHM, J, 0.063W	1	
	R4862	ERJ2GEJ473	M 47KOHM, J, 0.063W	1	
	R4863	ERJ2GEJ103	M 10KOHM, J, 0.063W	1	
	R4877, 78	ERJ2GEJ220	M 22 OHM, J, 0.063W	2	
	R4882	D0YAR0000007	M 0 OHM 1/4W	1	
	R5058	ERJ2GEJ103	M 10KOHM, J, 0.063W	1	
	R5069	ERJ2GEJ103	M 10KOHM, J, 0.063W	1	
	R5137	ERJ2GEJ103	M 10KOHM, J, 0.063W	1	
	R5400	DOGDR00Z0002	M 0 OHM, 1/10W	1	
	R5401	ERJ2RKF1001	M 1KOHM, 0.063W	1	
	R5402	ERJ2RKF3001	M 3KOHM, 0.063W	1	
	R5407	ERJ2GEJ103	M 10KOHM, J, 0.063W	1	
	R5408	ERJ2GEJ473	M 47KOHM, J, 0.063W	1	
	R5409	ERJ2GEJ103	M 10KOHM, J, 0.063W	1	
	R5410	ERJ2GEJ472	M 4.7KOHM, J, 0.063W	1	
	R5414	ERJ2RKF6342	M 63.4KOHM, 0.063W	1	
	R5415	ERJ2RKF1002	M 10KOHM, 0.063W	1	
	R5416	DOGDR00Z00002	M 0 OHM, 1/10W	1	
	R5421	ERJ2GEJ103	M 10KOHM, J, 0.063W	1	
	R5422	ERJ2GEJ473	M 47KOHM, J, 0.063W	1	
	R5423	ERJ2GED563X	M 56KOHM, J, 0.063W	1	
	R5424	ERJ2GEJ223	M 22KOHM, J, 0.063W	1	
	R5425	ERJ2GEJ103	M 10KOHM, J, 0.063W	1	

Safety	Ref. No.	Part No.	Part Name & Description	Pcs	Remarks
	R5431	ERJ2GEJ103	M 10KOHM, J, 0.063W	1	
	R5432	ERJ2GEJ473	M 47KOHM, J, 0.063W	1	
	R5433	ERJ2GEJ333	M 33KOHM, J, 0.063W	1	
	R5434	ERJ2GEJ223	M 22KOHM, J, 0.063W	1	
	R5435	ERJ12YJ471	M 470OHM, J, 1/2W	1	
	R5460	ERJ2GEJ473	M 47KOHM, J, 0.063W	1	
	R5461	D0YAR0000007	M 0 OHM 1/4W	1	
	R5464-67	D0YAR0000007	M 0 OHM 1/4W	4	
	R5468	ERJ2GEJ222	M 2.2KOHM, J, 0.063W	1	
	R5469, 70	ERJ2GEJ473	M 47KOHM, J, 0.063W	2	
	R5480	ERJ2GEJ473	M 47KOHM, J, 0.063W	1	
	R5481	ERJ2GEJ101	M 100 OHM, J, 0.063W	1	
	R5482	ERJ2GEJ470	M 47 OHM, J, 0.063W	1	
	R5483	ERJ2GED563X	M 56KOHM, J, 0.063W	1	
	R5484	ERJ2GEJ203X	M 20KOHM, J, 0.063W	1	
	R5485	ERJ2GEJ101	M 100 OHM, J, 0.063W	1	
	R5486, 87	ERJ2GEJ473	M 47KOHM, J, 0.063W	2	
	R5488	ERJ2GEJ183	M 18KOHM, J, 0.063W	1	
	R5489	ERJ2GEJ333	M 33KOHM, J, 0.063W	1	
	R5490	ERJ2GEJ472	M 4.7KOHM, J, 0.063W	1	
	R5491	ERJ6GEYJ331V	M 330 OHM J 1/10W	1	
	R5492	ERJ2GEJ680	M 68 OHM, J, 0.063W	1	
	R5493	ERJ2GEJ223	M 22KOHM, J, 0.063W	1	
	R5494	ERJ2GEJ683	M 68KOHM, J, 0.063W	1	
	R5496	ERJ6ENF8202	M 82KOHM, 1/10W	1	
	R5497	D1BD1602A044	M 16KOHM, 1/10W	1	
	R5498	ERJ6GEY0R00V	M 0 OHM J 1/10W	1	
	R5499	ERJ2GEJ472	M 4.7KOHM, J, 0.063W	1	
	R5500	ERJ2GEJ473	M 47KOHM, J, 0.063W	1	
	R5506	ERJ2GEJ473	M 47KOHM, J, 0.063W	1	
	R5507	ERJ2GEJ472	M 4.7KOHM, J, 0.063W	1	
	R5509	ERJ2GEJ101	M 100 OHM, J, 0.063W	1	
	R5563	ERJ2GEJ473	M 47KOHM, J, 0.063W	1	
	R5603	D1BB2002A055	M 20KOHM, 1/10W	1	
	R5604	D1BB4752A055	M47.5KOHM, 1/10W	1	
	R5605	D1BB2702A055	M 27KOHM, 1/10W	1	
	R5610	ERJ2GEJ5R6X	M 5.6 OHM, J, 0.063W	1	
	R5620	ERJ2GEJ680	M 68 OHM, J, 0.063W	1	
	R5629	D1BB2702A055	M 27KOHM, 1/10W	1	
	R5630	D1BB2402A055	M 24KOHM, 1/10W	1	
	R5631	D1BB5102A055	M 51KOHM, 1/10W	1	
	R5632	D1BB3002A055	M 30KOHM, 1/10W	1	
	R5633, 34	D1BB1602A055	M 16KOHM, 1/10W	2	
	R5635	ERJ2GEJ5R6X	M 5.6 OHM, J, 0.063W	1	
	R5718	D0YAR0000007	M 0 OHM 1/4W	1	
	R5719	ERJ2GEJ103	M 10KOHM, J, 0.063W	1	
	R5720	ERJ2GEJ153	M 15KOHM, J, 0.063W	1	

Safety	Ref. No.	Part No.	Part Name & Description	Pcs	Remarks
	R8001	ERJ2GEJ221	M 220 OHM, J,0.063W	1	
	R8002	ERJ2GEJ560X	M 56 OHM, J,0.063W	1	
	R8004	D1BB2402A055	M 24KOHM, 1/10W	1	
	R8005	D1BB1002A055	M 10KOHM, 1/10W	1	
	R8006	D1BB6801A055	M 6.8KOHM, 1/10W	1	
	R8030	ERJ2GEJ101	M 100 OHM, J,0.063W	1	
	R8031,32	D1BB2700A055	M 270 OHM, 1/10W	2	
	R8056-73	ERJ2GEJ470	M 47 OHM, J,0.063W	18	
	R8074	ERJ2GEJ221	M 220 OHM, J,0.063W	1	
	R8075-78	ERJ2GEJ470	M 47 OHM, J,0.063W	4	
	R8081	ERJ2GEJ103	M 10KOHM, J,0.063W	1	
	R8082	ERJ2RKF75R0	M 75 OHM, , 0.063W	1	
	R8083	ERJ2GEJ301	M 300 OHM, J,0.063W	1	
	R8084	D0YAR0000007	M 0 OHM 1/4W	1	
	R8086	ERJ2GEJ104	M 100KOHM, J,0.063W	1	
	R8087	ERJ2GEJ103	M 10KOHM, J,0.063W	1	
	R8090	ERJ2GEJ103	M 10KOHM, J,0.063W	1	
	R8091	ERJ2GEJ470	M 47 OHM, J,0.063W	1	
	R8093	ERJ2GEJ470	M 47 OHM, J,0.063W	1	
	R8094	ERJ2GEJ103	M 10KOHM, J,0.063W	1	
	R8097	ERJ2GEJ221	M 220 OHM, J,0.063W	1	
	R8098,99	ERJ2GEJ103	M 10KOHM, J,0.063W	2	
	R8100	ERJ2GEJ470	M 47 OHM, J,0.063W	1	
	R8101	ERJ2GEJ103	M 10KOHM, J,0.063W	1	
	R8106	ERJ2GEJ202	M 2KOHM, J,0.063W	1	
	R8107	ERJ2GEJ101	M 100 OHM, J,0.063W	1	
	R8108	ERJ2GEJ333	M 33KOHM, J,0.063W	1	
	R8109	ERJ2GEJ222	M 2.2KOHM, J,0.063W	1	
	R8150	D0GBR00Z0002	M 0 OHM J 1/16W	1	
	R8300,01	D0GBR00Z0002	M 0 OHM J 1/16W	2	
	R8302,03	ERJ2GEJ470	M 47 OHM, J,0.063W	2	
	R8304	D0YAR0000007	M 0 OHM 1/4W	1	
	R8305	D0GBR00Z0002	M 0 OHM J 1/16W	1	
	R8306,07	ERJ2GEJ102X	M 1K OHM J 1/4W	2	
	R8308	D0GBR00Z0002	M 0 OHM J 1/16W	1	
	R8309,10	D0YAR0000007	M 0 OHM 1/4W	2	
	R8311	D0GDR00Z0002	M 0 OHM, 1/10W	1	
	R8312,13	D0YAR0000007	M 0 OHM 1/4W	2	
	R8314	ERJ2GEJ221	M 220 OHM, J,0.063W	1	
	R8316	ERJ2GEJ471	M 470 OHM, J,0.063W	1	
	R8317	ERJ6GEYJ102V	M 1K OHM J 1/10W	1	
	R8318	ERJ2GEJ102X	M 1K OHM J 1/4W	1	
	R8319	D1BB1002A055	M 10KOHM, 1/10W	1	
	R8321	ERJ2GEJ222	M 2.2KOHM, J,0.063W	1	
	R8323	ERJ2GEJ221	M 220 OHM, J,0.063W	1	
	R8324	ERJ2GEJ222	M 2.2KOHM, J,0.063W	1	
	R8326	ERJ2GEJ103	M 10KOHM, J,0.063W	1	
	R8327	ERJ2GEJ473	M 47KOHM, J,0.063W	1	

Safety	Ref. No.	Part No.	Part Name & Description	Pcs	Remarks
	R8328	ERJ2GEJ101	M 100 OHM, J,0.063W	1	
	R8329	ERJ2GEJ220	M 22 OHM, J,0.063W	1	
	R8330	ERJ2GEJ470	M 47 OHM, J,0.063W	1	
	R8332	ERJ2GEJ470	M 47 OHM, J,0.063W	1	
	R8333	ERJ2GEJ220	M 22 OHM, J,0.063W	1	
	R8334,35	ERJ2GEJ470	M 47 OHM, J,0.063W	2	
	R8336	D0YAR0000007	M 0 OHM 1/4W	1	
	R8337	ERJ2GEJ220	M 22 OHM, J,0.063W	1	
	R8338	ERJ2GEJ473	M 47KOHM, J,0.063W	1	
	R8339,40	ERJ2GEJ472	M 4.7KOHM, J,0.063W	2	
	R8504	ERJ2GEJ103	M 10KOHM, J,0.063W	1	
	R8512	ERJ2GEJ103	M 10KOHM, J,0.063W	1	
	R8514	D0YAR0000007	M 0 OHM 1/4W	1	
	R8517-20	ERJ2RKD330	M 33 OHM, J, 2W	4	
	R8533	ERJ2GEJ103	M 10KOHM, J,0.063W	1	
	R8538-45	ERJ2GEJ220	M 22 OHM, J,0.063W	8	
	R8546,47	ERJ2GEJ332	M 3.3KOHM, J,0.063W	2	
	R8548	ERJ2GEJ472	M 4.7KOHM, J,0.063W	1	
	R8550	ERJ2GEJ472	M 4.7KOHM, J,0.063W	1	
	R8554,55	ERJ2GEJ220	M 22 OHM, J,0.063W	2	
	R8556	ERJ2GEJ472	M 4.7KOHM, J,0.063W	1	
	R8557,58	ERJ2GEJ332	M 3.3KOHM, J,0.063W	2	
	R8559	ERJ2GEJ560X	M 56 OHM, J,0.063W	1	
	R8566	EXB2HV103JV	RESISTOR ARRAY	1	
	R8568-71	ERJ2RKD330	M 33 OHM, J, 2W	4	
	R8572	EXB28V330J	RESISTOR ARRAY	1	
	R8573	EXB28V221J	RESISTOR ARRAY	1	
	R8574	ERJ2GEJ680	M 68 OHM, J,0.063W	1	
	R8575	ERJ2GEJ221	M 220 OHM, J,0.063W	1	
	R8614,15	ERJ2RKD330	M 33 OHM, J, 2W	2	
	R8617	ERJ2GEJ103	M 10KOHM, J,0.063W	1	
	R8618,19	ERJ2GEJ332	M 3.3KOHM, J,0.063W	2	
	R8661	ERJ2GEJ103	M 10KOHM, J,0.063W	1	
	R8663	ERJ2GEJ103	M 10KOHM, J,0.063W	1	
	R8721,22	ERJ2GEJ680	M 68 OHM, J,0.063W	2	
	R8765	ERJ2GEJ750	M 75 OHM, J,0.063W	1	
	R8767	ERJ2GEJ750	M 75 OHM, J,0.063W	1	
	R8770	ERJ2GEJ103	M 10KOHM, J,0.063W	1	
	R8772	ERJ2GEJ103	M 10KOHM, J,0.063W	1	
	R8866	D1BB91R0A055	M 91 OHM, 1/10W	1	
	RM2500	B3RAD0000127	REMOCON RECEIVE	1	
△	PCB	N0AE3FJ00001	MODULE P	1	PAVCA 32 inch
△	PCB	N0AE3FJ00002	MODULE P	1	PAVCA 37 inch

Safety	Ref. No.	Part No.	Part Name & Description	Pcs	Remarks
△	PCB	TXN/A10PRGS	CIRCUIT BOARD A	1	(RTL) PAVCA 32 inch
△	PCB	TXN/A10PQGS	CIRCUIT BOARD A	1	(RTL) PAVCA 37 inch
△	PCB	TNPA4834ABS	CIRCUIT BOARD V	1	(RTL) PAVCA
△	TU8300	ENGE6609KF	TUNER	1	PAVCA
	V10	K1KA07B00135	7P CONNECTOR	1	PAVCA
	X1101	HOJ100500035	CRYSTAL	1	
	X2010	HOJ245500089	CRYSTAL	1	
	X8001	HOJ270500061	CRYSTAL	1	
	X8300	HOJ250500079	CRYSTAL	1	PAVCA
	ZA5400-03	TESA169	SHIELD CLIP	4	
	ZA5405-16	TESA169	SHIELD CLIP	12	